



Electronic Crimping Tool HPS

Instruction Manual

Read this manual thoroughly before you use the product.
Keep this manual for future reference.

Original Instructions

This page is intentionally left blank.



Introduction

Read this Instruction Manual thoroughly before using the product.

Thank you for purchasing this product.

This manual describes the operation, usage cautions, and accessories for this product. Read this manual thoroughly before using the product and operate the product in accordance with the instructions in this manual.

Keep this manual for future reference.

IMPORTANT

- If the user or usage location changes, ensure that this manual is always kept together with the product.
- If this manual or a product warning label is lost or damaged, immediately contact your Shimadzu representative to request a replacement.

■ Notice



- Information in this manual is subject to change without notice and does not represent a commitment on the part of the vendor.
- Any errors or omissions which may have occurred in this manual despite the utmost care taken in its production will be corrected as soon as possible, although not necessarily immediately after detection.
- All rights are reserved, including those to reproduce this manual or parts thereof in any form without permission from Shimadzu Corporation.
- The contents of this manual have been edited by Shimadzu Corporation based on information provided by Chromatography Research Supplies (CRS).

Third-party trademarks and trade names may be used in this publication to refer to either the entities or their products/services, whether or not they are used with trademark symbol "TM" or "®".





© 2023 Shimadzu Corporation. All rights reserved.
Original version is approved in English.

Indications Used in This Manual

Precaution symbols are indicated using the following conventions:

Indication	Meaning
 WARNING	Indicates a potentially hazardous situation which, if not avoided, could result in serious injury or possibly death.
 NOTE	Emphasizes additional information that is provided to ensure the proper use of this product.

The following symbols are used in this manual:

Indication	Meaning
 Reference	Indicates the location of related reference information.
	Indicates a risk of getting your hands caught.
	Indicate a caution on using.
	Indicates safety glasses should be used.

Regulatory Information

For Europe:

The product complies with the following requirements.

EMC Directive, Machinery Directive, RoHS Directive

Product Name	Electronic Crimping Tool
Model Name	See the following table.
Manufacturer	Chromatography Research Supplies, Inc.
Address	2601 Technology Drive, Louisville, Kentucky 40299, USA
Authorized Representative in EU	Chromatography Research Supplies, Inc.
Address	c/o Authorised Representative Service 77 Camden Street Lower, Dublin, D02 XE80, Ireland
Authorized Representative in UK	Chromatography Research Supplies, Inc.
Address	c/o Authorised Representative Service The Old Methodist Chapel, Great Hucklow, Buxton, SK17 8RG, England

Electronic Crimping Tool HPS Type B (JPN)	227-35503-01
Electronic Crimping Tool HPS Type B (USA)	227-35503-02
Electronic Crimping Tool HPS Type G (UK)	227-35503-03
Electronic Crimping Tool HPS Type I (AU)	227-35503-04
Electronic Crimping Tool HPS Type C (EU)	227-35503-05
Electronic Crimping Tool HPS Type I (CN)	227-35503-06





Contents

Introduction	i
Indications Used in This Manual	ii
Regulatory Information	ii
Warnings, Intended Use, Limits	1
Description and Setup	3
Operation	3
Storage and Shipping	8
Error Conditions	8
Maintenance and Repair	8
Appendix	10





	Model Number
Electronic Crimping Tool HPS Type B (JPN)	227-35503-01
Electronic Crimping Tool HPS Type B (USA)	227-35503-02
Electronic Crimping Tool HPS Type G (UK)	227-35503-03
Electronic Crimping Tool HPS Type I (AU)	227-35503-04
Electronic Crimping Tool HPS Type C (EU)	227-35503-05
Electronic Crimping Tool HPS Type I (CN)	227-35503-06
Related Items	Item Number
Crimping Tool Stand	227-35508-01
Base for Electronic Crimping Tool	227-35510-01
11 mm Crimper Jaw Set	227-35504-01
20 mm Crimper Jaw Set	227-35504-02
11 mm Decapper Jaw Set	227-35505-01
20 mm Decapper Jaw Set	227-35005-02

This page is intentionally left blank.

Warnings, Intended Use, Limits

Markings	Note
	Indicates that the product complies with the Essential Requirements set out in sector-specific EU directives and regulations.
	It indicates that it is compliant with the China RoHS.
	Indicates that the product complies with the AS/NZ EESS
	Indicates that the product complies with the UK Conformity Assessed
 12V 11.5 A max.	It indicates electrical connection data. Do not supply more than the specified voltage/current.

Warnings

! WARNING	
	<ul style="list-style-type: none"> Never insert fingers into the crimper or decapper. The crimper or decapper jaws can pinch severely.
	<ul style="list-style-type: none"> Follow all instructions or injury may result. Only change jaws after the power supply has been disconnected or the tool is in Settings Mode. Use only the 12 volt DC Power Supply supplied with the crimping tool.
	<ul style="list-style-type: none"> It should not be disposed of with general household waste.
	<ul style="list-style-type: none"> Please make sure to wear protective goggles during crimping or decapping.

Intended Use

Electronic Crimpers and Decappers are intended for use in a laboratory environment.

Prohibited Use

All other uses are prohibited.

Limits

Temperature 15 °C to 35 °C
Humidity not more than 75%
Pressure 0.75 to 1 bar

Sound Pressure

Sound pressure $L_{pA} = 79 \text{ dB(A)}$

Recycling

For recycling contact your local distributor.



Description and Setup

Description

The Electronic Crimping Tool HPS can be used to crimp and decap standard crimp caps on laboratory sample vials. A variety of jaw sets can be used to accommodate the most popular sizes.

Crimping Tool Setup

Remove the instrument, power supply and cable from the shipping container. If there is any visible damage, contact your supplier immediately.

Operation

Connecting the Power Supply

Connect the 12 volt DC supply to the mains with the power cord provided and also to the connector on top of the crimping tool.



Set Jaw Type and Change Jaw

First, press the Setting Button with a pen or small tool.

Install a Jaw Set

Insert the crimping tool jaw set into the bottom bushing of the tool. Twist counterclockwise until the spring is pushed up and it is securely fixed in place.

To remove the crimping tool jaw set, press the button located on the outside of the jaw set as shown in the blue arrow below and twist clockwise.



Press ▼ or ▲ select Change Jaws.

The numerical numbers indicate cap diameter, C represent crimper and D represent decapper.



For example, to set the tool to decap 11 mm vials, select Settings Mode >Change Jaw > 11D > Confirm

Compatible Vials, Caps and Seals

Standard aluminum or steel caps or two-part caps with aluminum sides and magnetic tops together with seals of standard size and thickness are appropriate. 20 mm caps with very thin seals cannot be removed with the 20 mm decapper jaw set.

Using the Tool for crimping

The cycle button must be held down until the crimp is complete. If the switch is released early the crimper will retract and show an error.



Adjust the crimper setting for satisfactory form and tightness. Use the ▼ and ▲ buttons to adjust the tightness of the crimp. If the cap spins easily, press the ▲ button two or three times. If it is too tight, press the ▼ button.

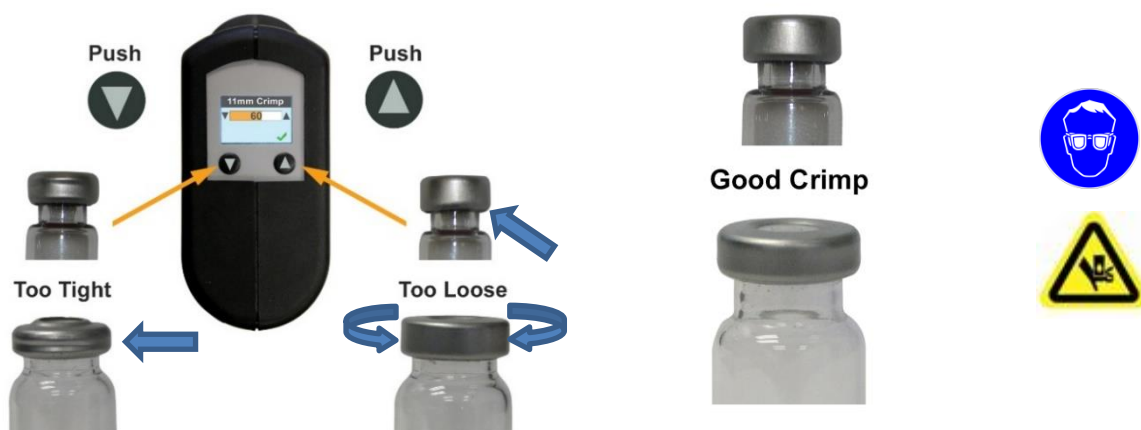

Check that the cap is neatly crimped all the way down to the bottom side of the vial neck. Also, check that the cap cannot be turned easily by hand. If it can be turned easily by hand, increase the crimp strength. Check the shape of the cap. If there is an indentation on the side of the cap, decrease the crimp strength.

NOTE

Crimping the same vial two times will not generally give the same results and sometimes will result in vial breakage.

Special considerations for 20 mm Headspace vials

It is common practice to use the “twist test” to check headspace vials for satisfactory crimps. Many sealing systems hold pressure perfectly well so long as the seal is well compressed.

When using heat-resistant caps or steel caps

Steel crimp caps require more strength to crimp than aluminum caps. However, be aware that if you increase the crimp strength too much, the seal may tear when the needle is inserted.

Using the HPS Tool for decapping

The adjustment is not very important when decapping. As shipped from the factory the decapper should remove a cap satisfactorily.

To adjust decappers make sure that the stroke is long enough to remove the cap.



NOTE

If the steel cap cannot be decapped or the vial is broken, cut the cap with nippers or pliers.

Settings

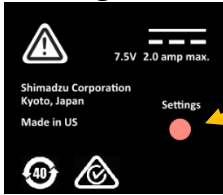

To Enter Setup Mode

Press the Setting Button with a pen or small tool. (Or hold the Cycle Button for 3 seconds after a cycle)

Press ▲ and ▼ to scroll through the menu.

Use the Cycle Button to make a selection.

Language selection:

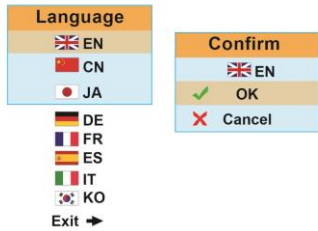
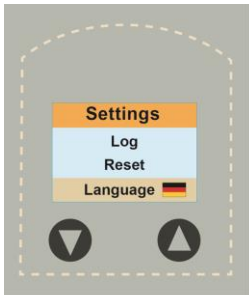

Jaw Set Selection:

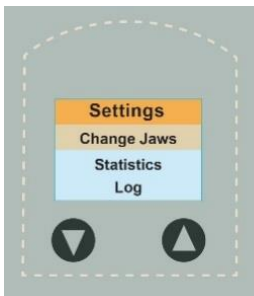

C: Crimper
D: Decapper

Statistics:

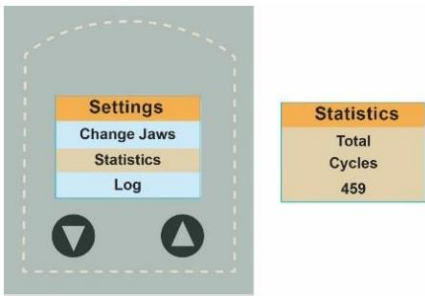

Log of recent crimping results:

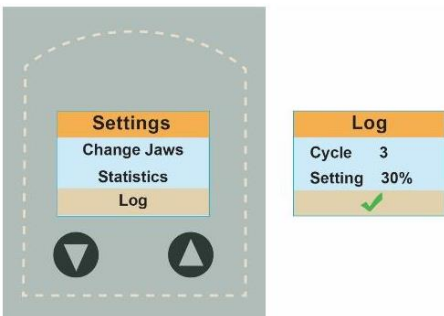

Reset:

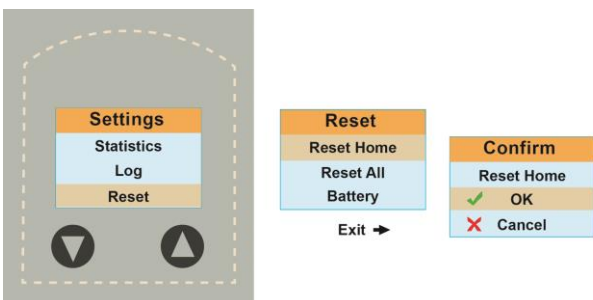



- **Reset Home** - Sends the crimper back to its home position. No settings, logs, or statistics are changed.
- **Reset All** - Sends the crimper back to its home position and returns the tightness setting to the original factory default of 50%. No logs or statistics are changed.

Storage and Shipping

Remove the jaw set and place it in the provided plastic container when storing or shipping the tool.

Error Conditions

Errors are identified by Error Messages, normally after a crimp cycle.

Error	Possible Cause	Recommendation
 Stall	Stall Condition - Crimp Setting is too high.	Adjust crimper to a lower crimp setting by pressing the ▼ button
 Early Button Release	Early trigger release - the tool retracted before completing cycle.	Try again, making sure to hold the button down until the tool is returning to the home position.
 Stall but tool does not cycle.	Motor drive failure.	Contact your local distributor for repair and support.

Maintenance and Repair

General Maintenance

The electronic crimper tools do not contain user serviceable parts.



Cleaning

The crimping tool may not be immersed in water or solvent. The outside of the case may be cleaned with an ordinary detergent and wiped off with a damp rag. Care should be taken not to get the electronics wet.

Avoid permitting metal parts of the crimping tool to contact corrosive material during use. If they do, try to wipe them clean with a suitable mild neutralizing solution.

Troubleshooting

Condition	Possible Cause	Recommendation
Side of cap is indented. Seal is deformed in hole.	Crimp setting is too high. The crimp is too tight.	Adjust crimper to a lower crimp setting by pressing the ▼ button.
Cap spins easily.	Crimp setting is too low. The crimp is too loose.	Adjust crimper to a higher setting by pressing the ▲ button.
Cannot find a good crimp setting.	The crimper is far out of adjustment.	Return crimper to factory setting. See “Reset” above.
Crimping is inconsistent. Some vials are good and some are not.	Vials, caps or seals are inconsistent.	Check crimper by using some standard, approved, vials caps and seals.
	Electronic failure in crimper.	Contact your local distributor for repair and support.
11mm decapper leaves caps hanging on vials	Decapper adjustment is too low.	Adjust the decapper to a higher setting by pressing the ▲ button.
	Jaws are worn or broken.	Contact your local distributor for repair and support.
Motor does not come on or moves in one direction only.	Drive circuit failure.	Contact your local distributor for repair and support.

Appendix

A. Accessory Base for Electronic crimpers

