



Agilent 6560 Ion Mobility Q-TOF LC/MS System

ADD A NEW DIMENSION TO YOUR RESEARCH

The Measure of Confidence



Agilent Technologies

SEE WHAT YOU'VE BEEN MISSING

Reveal More Details Than Ever Before

Whether your research involves characterizing small molecules or proteins, increasing metabolite coverage maps, or ensuring food safety, the Agilent 6560 Ion Mobility Q-TOF LC/MS system will reveal details you've never been able to resolve before.

With unmatched selectivity and sensitivity, the 6560 can detect, identify, and characterize the components of your most complex samples.





With this innovative instrument, you will be able to:

- **Clearly separate** molecules based on their size, shape, and charge.
- **See changes** in the structure of a particular molecule—changes that directly affect the way it behaves.
- **Characterize a wide range of analytes**—whether proteins, metabolites, lipids, or carbohydrates.
- **Study drug binding and its effect on molecular conformation**, which may be the difference between having no biological effect and actually being efficacious.

These are research challenges that scientists are already tackling with the Agilent 6560 Ion Mobility Q-TOF LC/MS system.

SENSITIVITY THAT SHOWS

Separate Unresolved Analytes

Erin Baker, a leading ion mobility scientist and chairperson for ASMS ion mobility workshops, has been collaborating with Agilent on a groundbreaking new system that combines ion mobility with liquid chromatography and mass spectrometry.

The results have been impressive, to say the least.

“A lot of times it’s the things you don’t know that end up being the most important,” Dr. Baker says. **“This system can give you information about everything in your sample.”**

If one molecule has the same mass-to-charge ratio as another, and is present at only a very low concentration, it can be difficult, if not impossible, to detect with other techniques.

“With ion mobility, we’re able to detect molecules at really low concentration levels,” Dr. Baker says. **“Where we used to be looking at ng/mL, we are now looking at high pg/mL.”**

If you’re looking for low-level peptides—which researchers like Dr. Baker refer to as the needle in the haystack—that sensitivity becomes all-important.

For a number of diseases, the crucial clue may be the shape of a particular protein.

A mass spectrometer can only tell you which protein is there, but not the shape. **“With ion mobility you can tell if the protein is all tangled up, or it’s more extended, or it’s malformed in some way,”** says Dr. Baker. **“That’s vital information.”**

With this new instrument from Agilent, you can get a lot of detailed information very quickly.

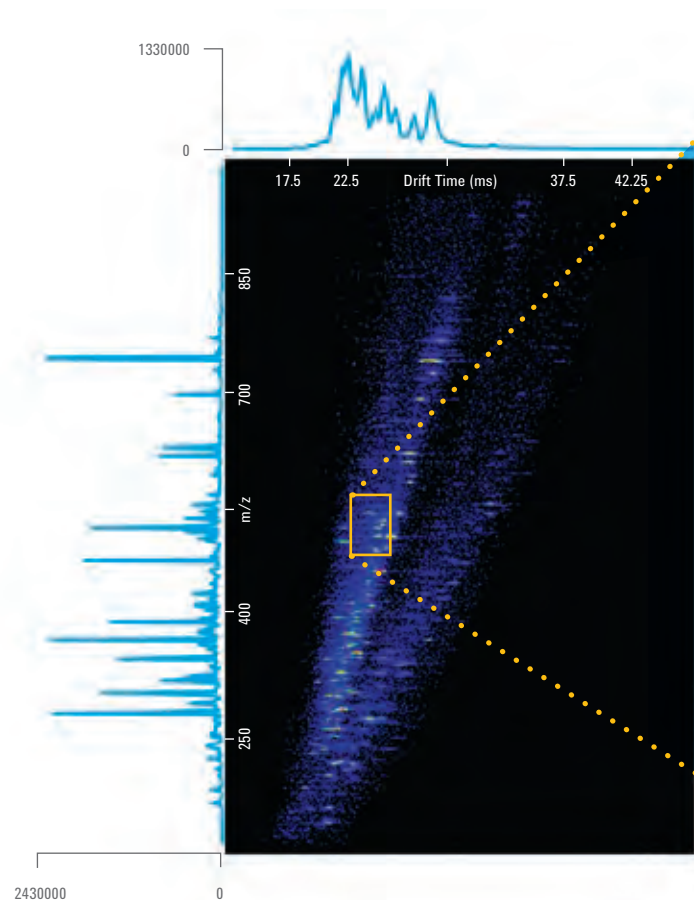

The m/z versus drift plot shows the separation of tryptic peptides derived from a sample of mouse blood plasma spiked with 20 reference peptides. The sample was subjected to LC separation for 15 minutes before IM Q-TOF analysis. The inset shows a zoomed-in region of the 3-D plot where 10 peptides were identified.

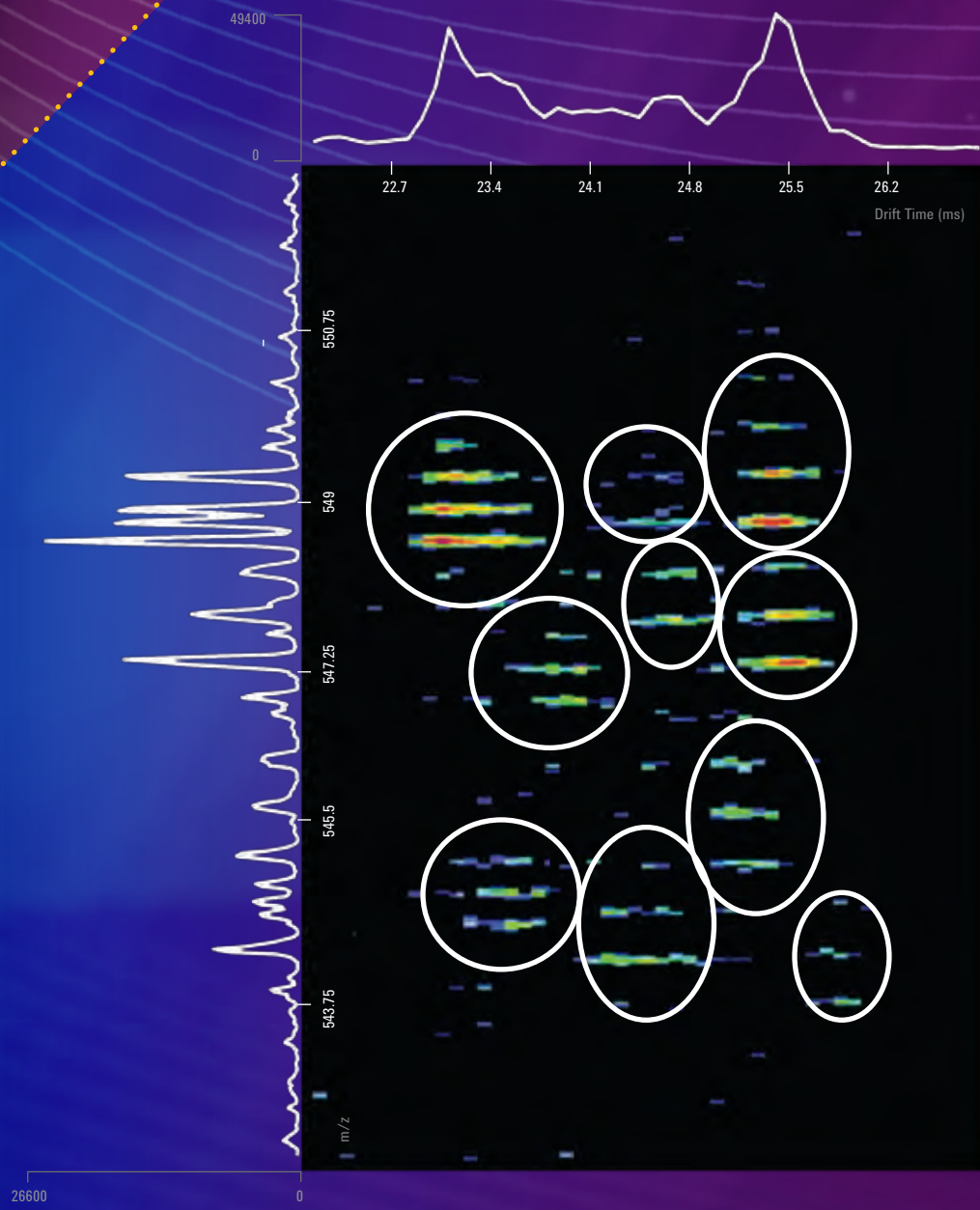

'THIS INSTRUMENT WORKS'

Precision Opens New Opportunities

"We have a tool here that gives us some opportunities to address questions that perhaps we've never even imagined before."

That's how Dr. Alfred Yergey, Scientist Emeritus with the National Institutes of Health in Bethesda, Maryland, assesses the Agilent 6560 Ion Mobility Q-TOF LC/MS system.

"It's a tool that opens up one's ability to imagine different kinds of experiments," says Dr. Yergey. **"It's basically a way of interrogating gas phase ion chemistry in a fashion that one really couldn't imagine before the existence of this device."**

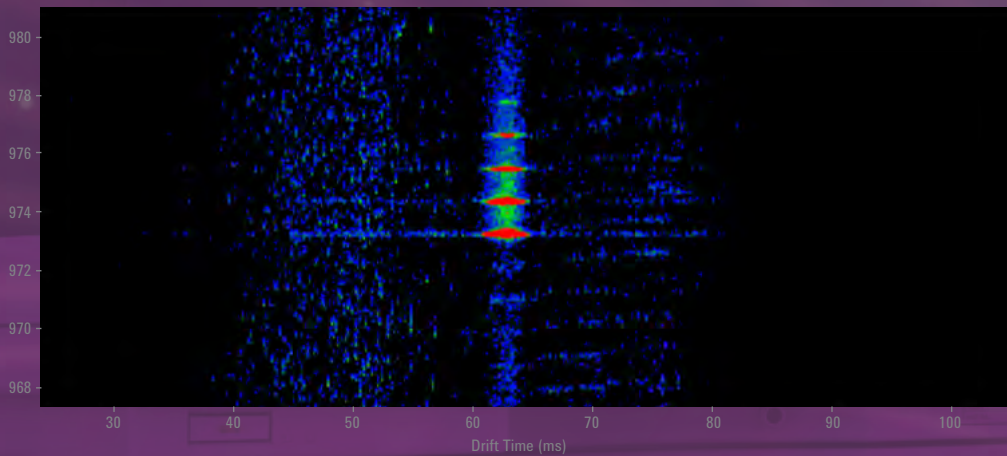

The 6560 is the first commercial instrument that enables researchers to address truly fundamental questions about structure, function, and the workings of complex biological systems with real confidence and ease.

Much of Dr. Yergey's enthusiasm, in fact, stems from the accuracy of the system.

"When you calculate a collision cross section with this device, what you get is a believable number," he says.

With other commercial systems, results must be calibrated in comparison to previously established values for similar compounds found in the scientific literature. That's a pretty big drawback if you're dealing with molecules that don't yet have an established value.

"The results that you get with this tool can be justified on the basis of first principles," Dr. Yergey observes. **"The device behaves exactly the way you would expect it to behave in light of the long history of gas phase ion chemistry."**

Both positive ion and negative ion nitrogen drift data of the same compound (cyclodextrin) in protonated and deprotonated form. CCS calculations in positive and negative mode showed CCS values within 2% accuracy. A) One well resolved drift peak in positive mode. B) Two different peaks (singly charged monomer as well as doubly charged dimer) in negative mode. Lower intensity peak contains two different conformers, possibly indicating that the dimers exists as two conformers.

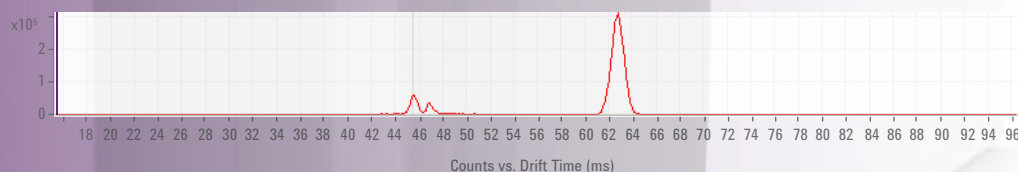
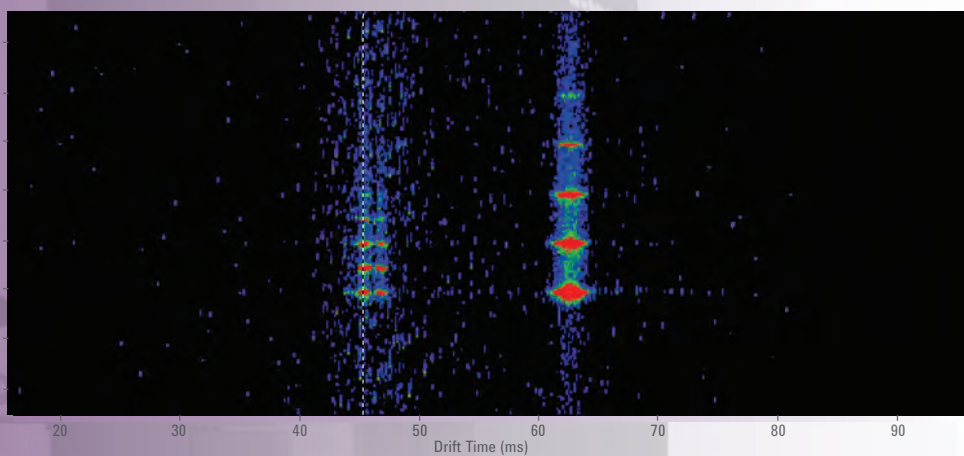

B

PAN-OMIC DISCOVERY TOOL

Seeking The Unknown

The Agilent 6560 Ion Mobility Q-TOF LC/MS represents an incredible advance for biologists trying to understand how genes, proteins, and metabolites interact as a whole system.

Just ask Dr. John McLean. At Vanderbilt University, in Nashville, Tennessee, he heads the Laboratory for Structural Mass Spectrometry, which performs experiments for biologists, immunologists, pathologists, and other scientists.

“The real problem with systems biology is you have to do millions of experiments to be able to discern small things, small networks in biology,” says Dr. McLean. **“In proteomics, you will be waiting for hours to detect the changes in protein expression levels. Metabolomics, on the other hand, provides a rapid reflection of biological responses that can serve as an effective indicator of biological state. If you’re trying to understand disease states, for example, you have to be able to look at the molecules that are being expressed together under those conditions.”**

And that’s where the 6560 really shines.

“We’re breaking the paradigm of proteomics studies or genomics studies—any of the individual omics—and instead taking what we like to think is a truly untargeted, unbiased survey of the molecular inventory,” he says, **“using ion mobility coupled with mass spectrometry.”**

Dr. McLean and his team at Vanderbilt have a deep appreciation of how these technologies work in concert with each other. They have been building their own systems for years, where resolving power is a key metric for the separation of different molecular classes.

“In our experience, a resolving power of greater than 20 is necessary to begin to resolve out chemical classes in conformation space, but with the Agilent platform, in some cases we’ve achieved 80,” he says. **“This allows us to resolve out the fine structure in molecular class distributions for even higher confidence assignments within a molecular class—for example, distinguishing molecular sub-classes such as sphingolipids from glycerophospholipids.”**

The enhanced sensitivity and resolution helps uncover more compounds in complex mixtures.

Dr. McLean notes that other researchers are often surprised by the pan-omic nature of the technology.

“This is going to make a big splash in biology,” he says.

* May, J.C., Goodwin, C.R., Lareau, N.M., Leaptrot, K.L., Morris, C.B., Kurulugama, R.T., Mordehai, A., Klein, C., Barry, W., Darland, E., Overney, G., Imatani, K., Stafford, G.C. Fjeldsted, J.C., McLean, J.A. Anal Chem 2014, (Feb 18, 2014; 2107-2116) Conformational Ordering of Biomolecules in the Gas-Phase: Nitrogen Collision Cross-Sections Measured on a Prototype High Resolution Drift Tube Ion Mobility-Mass Spectrometer.



PAN-OMICS MAPPING OF EMPIRICAL DATA

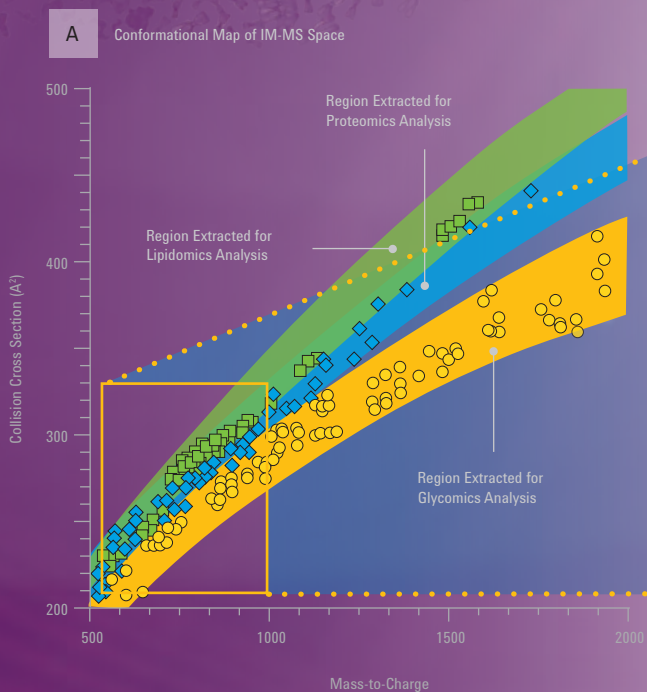

A) Complex sample containing a mixture of lipids, peptides, and carbohydrates was infused directly into the instrument and resolved in 2-D IM Q-TOF analysis by collision cross-section and m/z . Conformational space maps allow complex mixtures to be separated based on different biomolecular classes, with little front-end sample workup.*

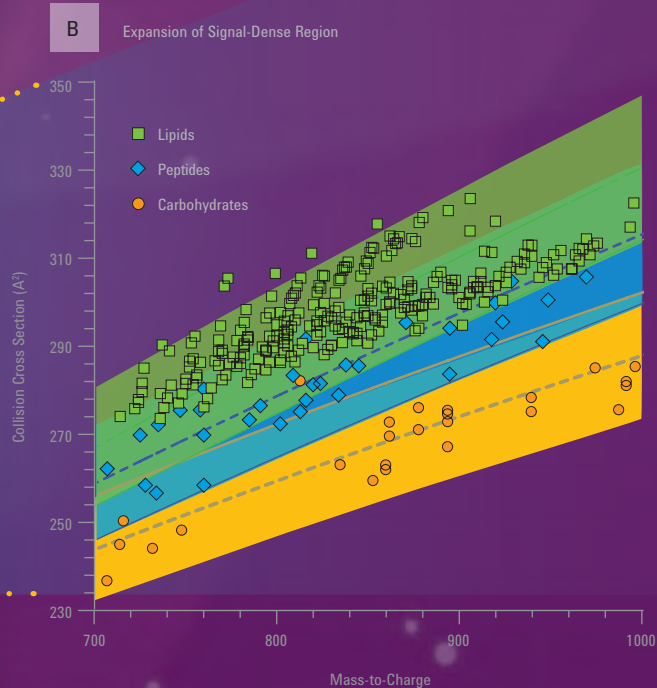

B) is a zoomed-in region where a high density of signal occurs. Distinguishing individual ion signals by the m/z measurement alone is challenging, yet the combined structural separation of IM Q-TOF provides a means of delineating the data into chemical class-specific regions.*



CHARACTERIZING BIOTHERAPEUTIC DRUGS

Effectively Study Protein Conformation

Biotherapeutic drugs based on antibodies are among the most successful and fastest growing new therapies for cancer and other conditions. In all cases, scientists have observed that protein shape can have significant effects on the efficacy of these drugs. What this means for lower cost biosimilars is clear: To be effective, they must have a similar structure to a patented biotherapeutic drug.

With three dimensions of separation, the Agilent 6560 Ion Mobility Q-TOF LC/MS system can provide the molecular details that no other system can match.

Ion mobility has proved to be an effective tool for addressing different protein conformations (protein folding, disulfide bond mismatching), which are not easily determined by conventional LC/MS techniques. Ion mobility Q-TOF provides added selectivity for glycoprotein and isomer separations. As a result, the 6560 can quickly determine whether an isoform is present by comparing individual drift times and collision cross-sections for each molecule.

Envision being able to dig deeper into specific characteristics of proteins, such as antibody-drug conjugates and drug-antibody ratios, or being able to pinpoint different drug conjugation sites that have similar drug-antibody ratios. That's the exciting potential the Agilent 6560 with ion mobility separation brings—the potential to develop more effective biotherapeutics.

A

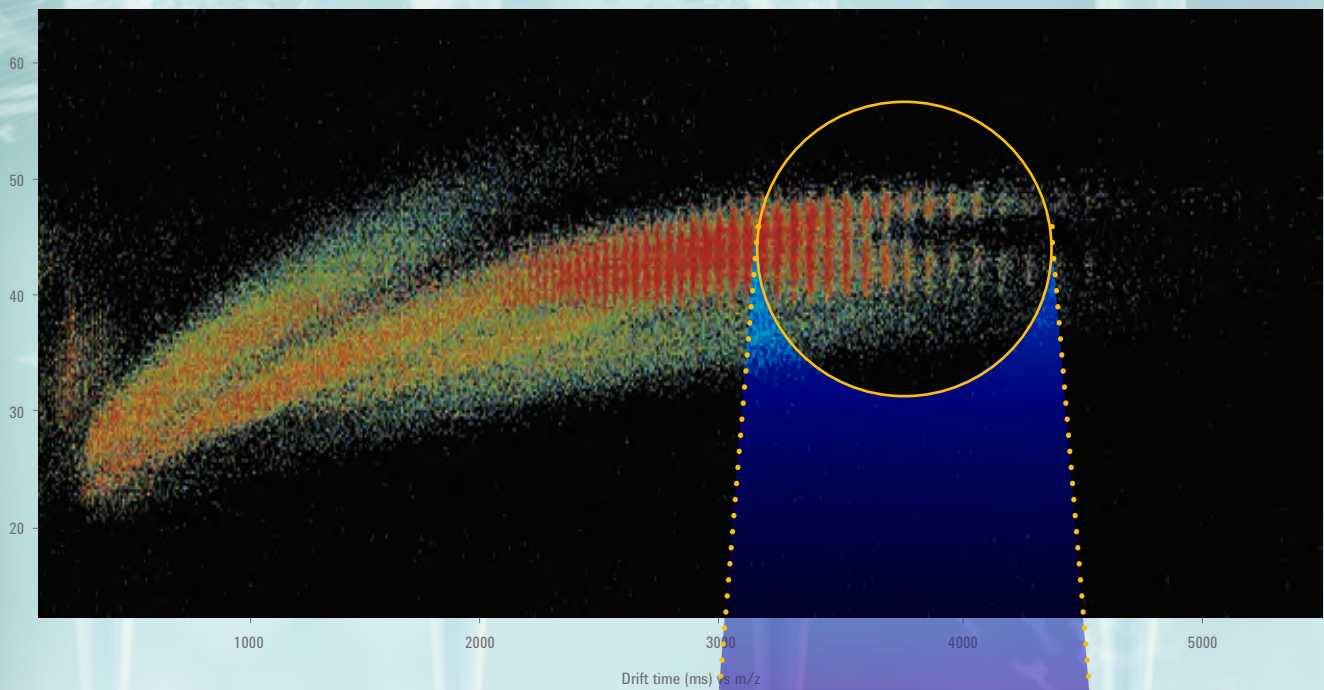

B

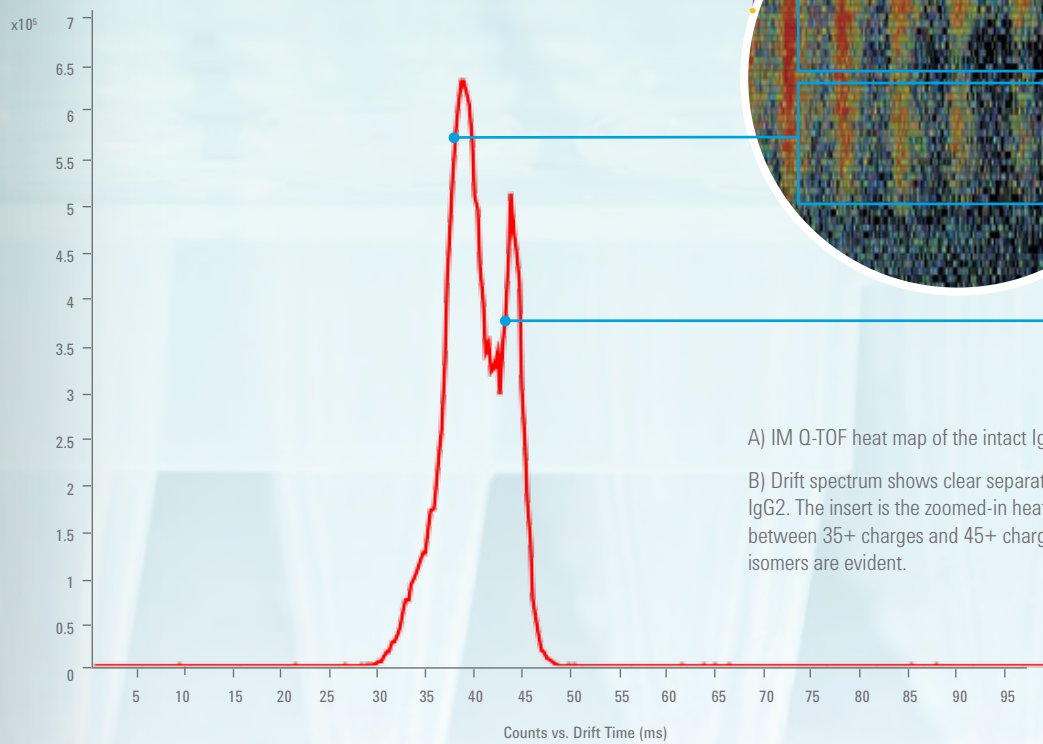

A) IM Q-TOF heat map of the intact IgG2.

B) Drift spectrum shows clear separation of two different conformations of IgG2. The insert is the zoomed-in heat map of IgG2 lower charge states, between 35+ charges and 45+ charges, where the separation of the two isomers are evident.



AGILENT'S UNIQUE DESIGN

Built On Breakthrough Technology

Why all the excitement about a separation technique that has been around for more than 100 years? Because only now is it realizing its true potential, thanks to a number of recent innovations.

The emergence of modern ion funnel technology coupled with uniform drift tubes, pioneered by Dr. Richard Smith, has enabled greater than 50-fold sensitivity gains for ion mobility coupled with high-resolution mass spectrometry.

Now the innovative 6560 takes this technology further than ever with an exclusive ion funnel design. Each segment of the dynamic funnel assembly, which includes a front funnel for sample enrichment, trapping ion funnel, drift tube, and focusing rear funnel, is carefully designed to improve ion transmission from the source to the Q-TOF high-resolution mass analyzer.

"Ion funnel technology could possibly be the most significant MS development since the introduction of the API. It delivers a fundamental sensitivity and detection-limit breakthrough—resulting in performance far exceeding the capabilities of conventional mass spectrometers."

DR. RICHARD SMITH, INVENTOR OF THE ION FUNNEL

Uniform field ion mobility designs have existed for many years, but these early research designs suffered from very high ion losses (> 99.9%) without the use of electrodynamic funnels. Agilent's drift funnel design excels at preserving ions along each segment of the optics pathway by careful ion focusing in every segment of the electrodynamic funnel. This design results in only a two-fold loss in ion signal when compared to the standalone high-resolution Agilent 6550 Q-TOF LC/MS.

What's more, Agilent iFunnel technology provides a level of robustness unmatched by other dual-funnel designs, combining true orthogonal electrospray orientation with Agilent Jet Stream ionization technology. This minimizes the transmission of uncharged species and ion clusters, which reduces background noise.

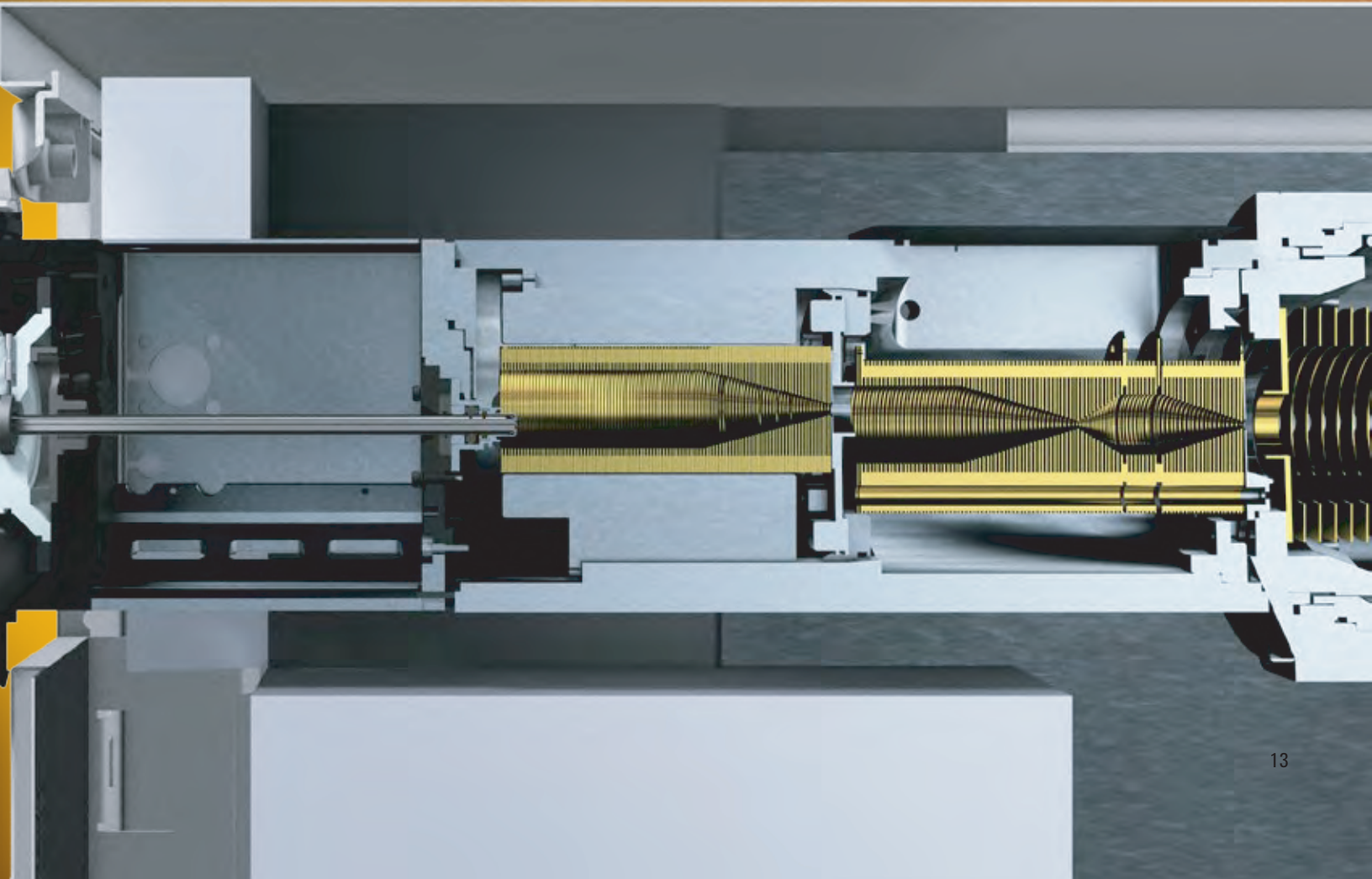

THE AGILENT 6560

With Ion Mobility Separation

Now you can take advantage of all three dimensions of separation with one system. The 6560 combines the power of the 1200 Infinity Series HPLC, ion mobility, and a high-resolution, accurate-mass Q-TOF system, so you can easily expand your scientific research capabilities.

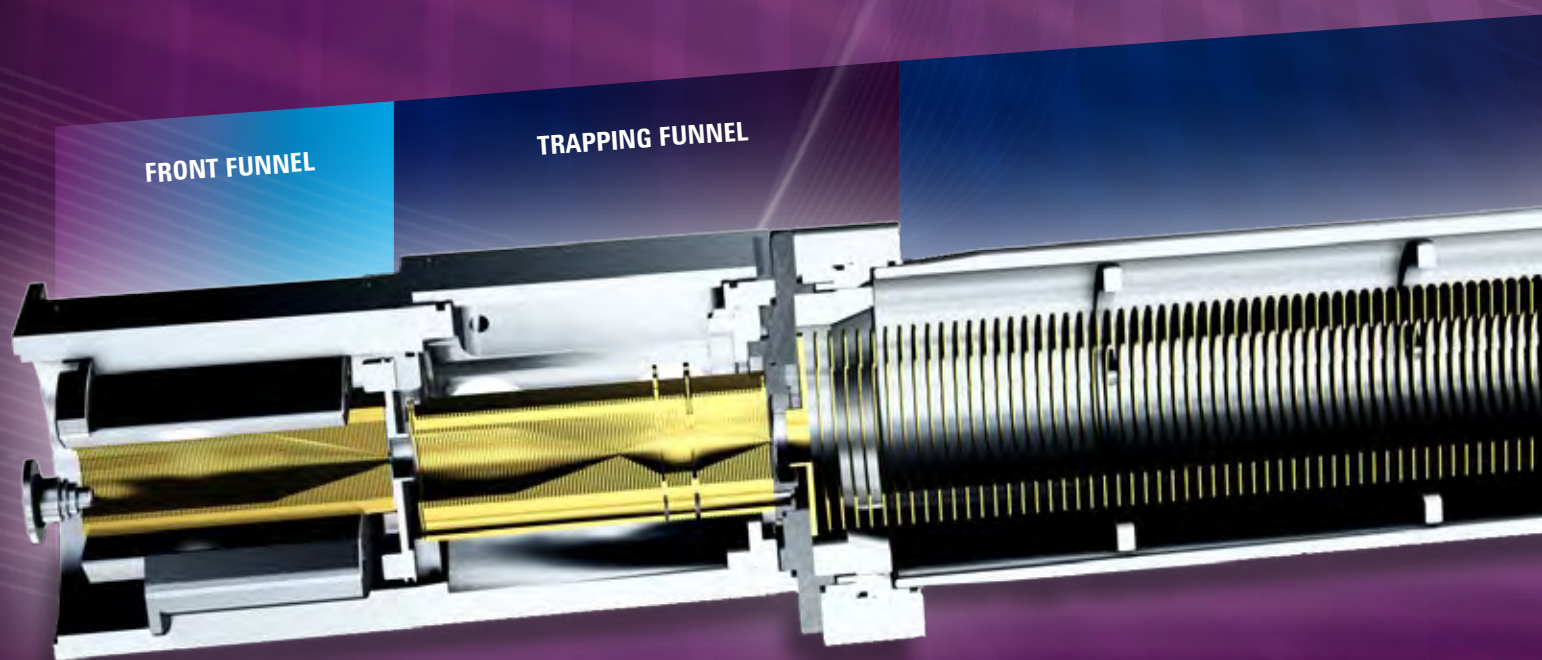

RESOLVE STRUCTURAL ISOMERS

- Effortlessly probe the molecular structure and conformation of peptides and proteins using high-resolution ion mobility separation.
- Directly determine molecular size (from collision cross sections) without reference standards or calibration tables.

INCREASE PEAK CAPACITY

- Effectively resolve individual components in complex mixtures with the combined power of UHPLC, ion mobility, and mass spectrometry.
- Obtain optimal ion mobility separation with double-grid trapping technology.

FIND AND CONFIRM MINOR COMPONENTS

- Readily detect low femtogram analytes in complex matrices using electrodynamic funnel technology.
- Confidently confirm compounds using All Ions MS/MS.

PRESERVE PROTEIN CONFORMATIONS

- Easily study gas phase peptide and protein structures.
- Effectively minimize ion heating effects to maintain molecular conformations.

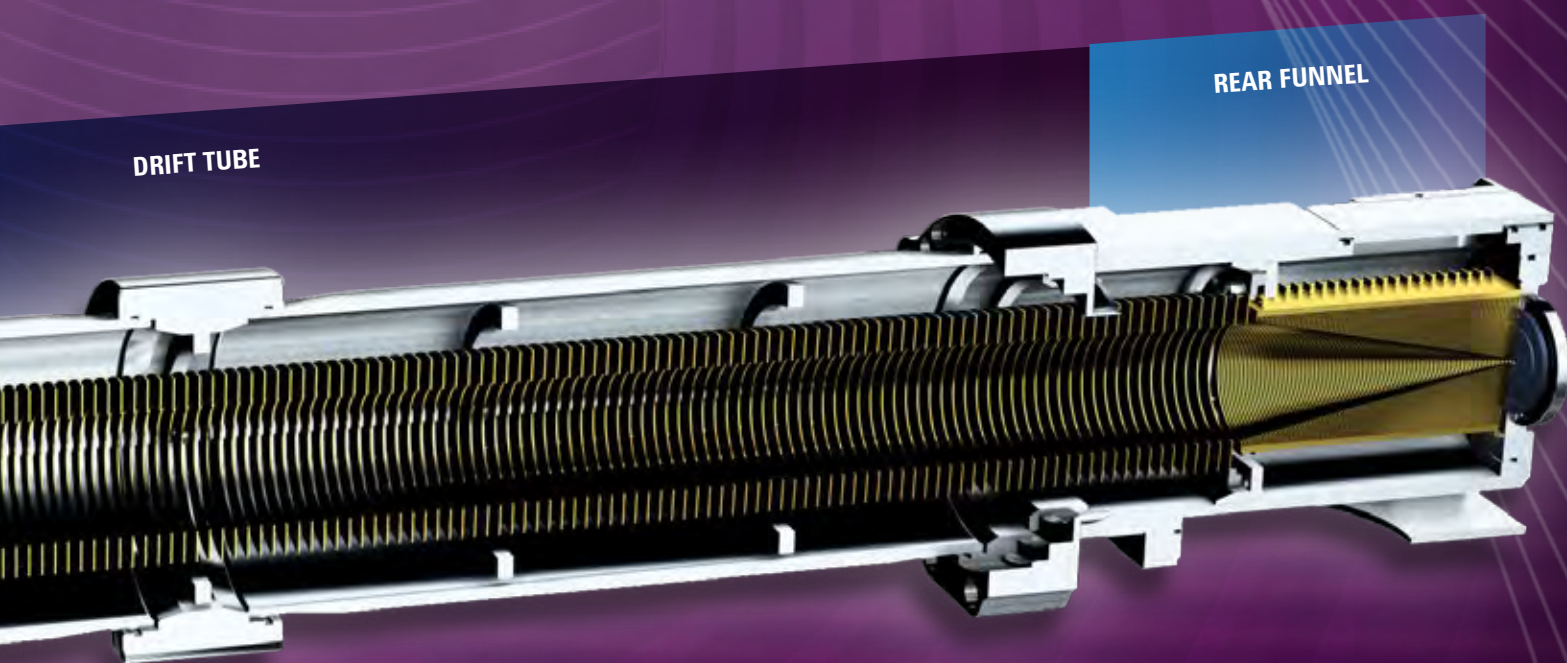



PEAK CAPACITY REACHES NEW HEIGHTS

Engage Three Dimensions Of Separation

Combining the orthogonal separation techniques of liquid chromatography, mass measurement, and ion mobility tremendously enhances overall peak capacity—giving you the ability to more effectively characterize a variety of molecules. For in-depth analysis of complex samples, complete separation of multiple compounds may not be possible with liquid chromatography alone. Even subsequent high-resolution mass analysis may be insufficient to separate and identify isobaric compounds. So, with this system, the added gas phase ion mobility separation dramatically increases the peak capacity of the analysis. Simply put, you can now resolve and detect a greater number of compounds/components than ever before.

RESOLUTION MATTERS

Ion mobility adds an orthogonal dimension of separation to your LC/MS analyses. The ion mobility portion enables gas phase removal of background noise and increases the limits of detection for low-level components in complex samples.

SELECTIVITY MATTERS

An extra dimension of selectivity is critical when you need to differentiate structural isomers, various conformations of biomolecules, or different charge states. In the 6560 ion mobility drift tube, the enhanced selectivity results from the difference in ion transit times through the electric field within the drift cell. The molecular size, shape, and charge of the ions determine their transit times.

A

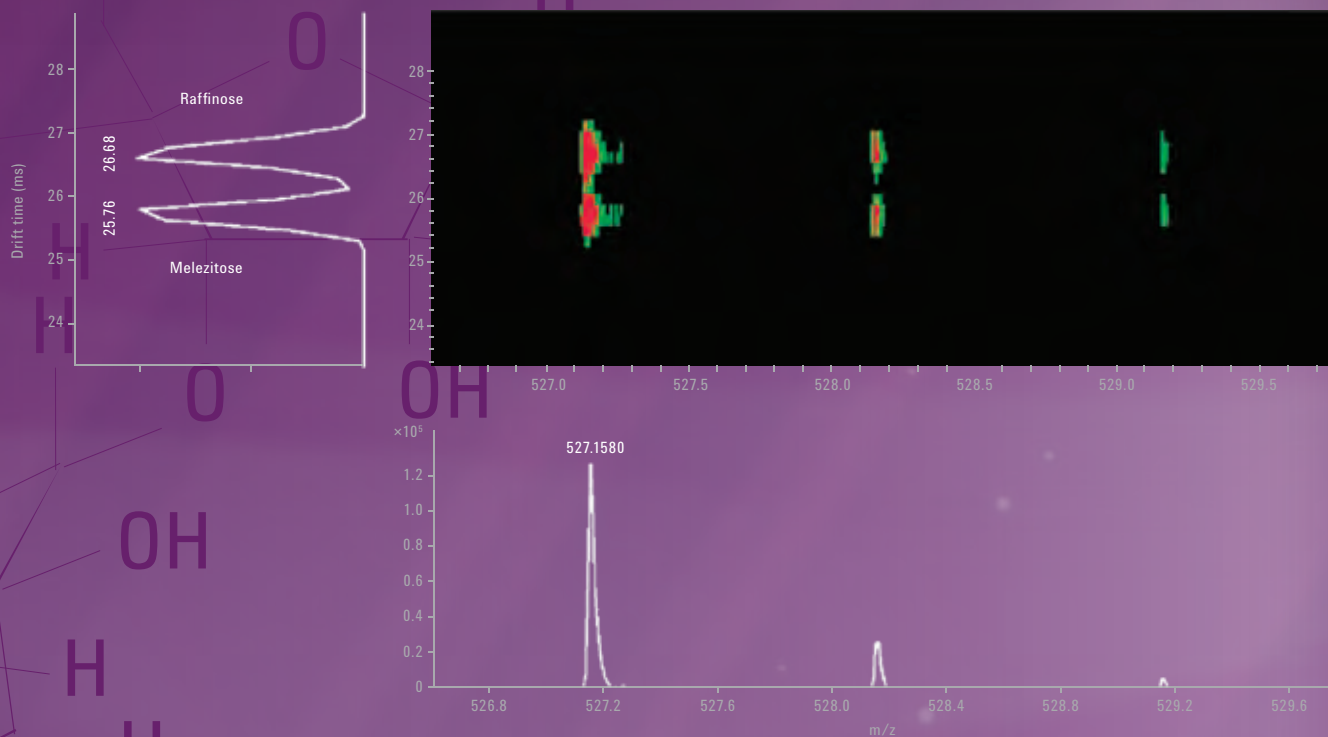

Separation of isobaric trisaccharides using IM Q-TOF: A one-to-one mixture of melezitose and raffinose was infused using a syringe pump. These two carbohydrates can be baseline separated using the ion mobility drift cell and detected using the Q-TOF mass analyzer as sodium adducts. The ion mobility resolving power for this separation is 60.

B

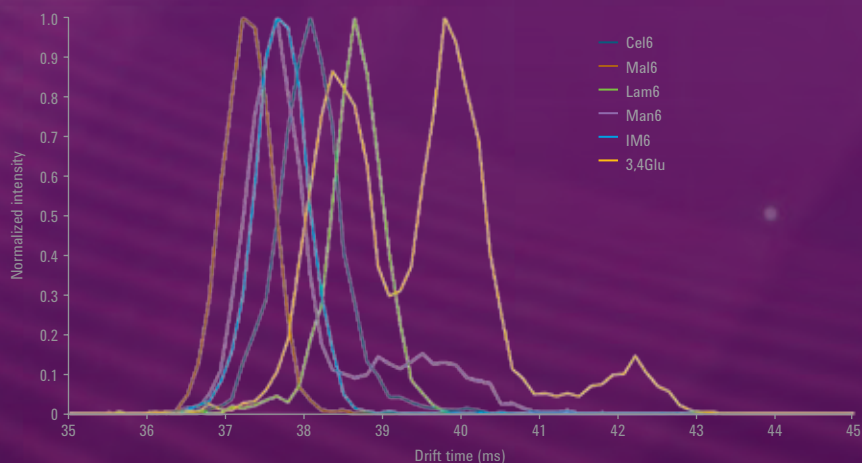

IM Q-TOF separation of permethylated oligosaccharides. These oligosaccharide samples were infused separately and analyzed using IM Q-TOF as sodium adducts. These isobaric hexoses show different drift distributions, indicating their structural differences. Ion mobility separation is a valuable technique that can be used to separate isobaric compounds with different structures.

ALL IONS, ALL THE TIME

Quickly Detect Low-Level Compounds

Agilent All Ions MS/MS is a technique available on Agilent's high-resolution Q-TOF LC/MS instruments. When combined with Agilent's exclusive and comprehensive Personal Compound Database and Libraries (PCDL), this cutting-edge technique gives you an unparalleled ability to confidently screen for compounds in complex mixtures.

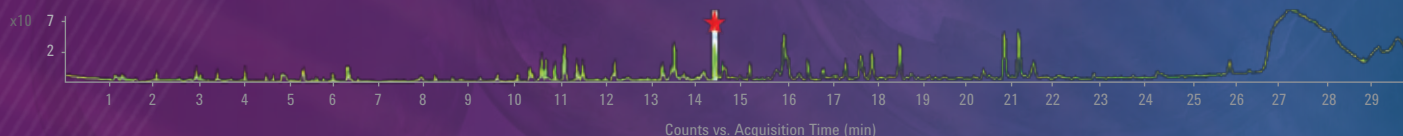

Traditional data-dependent MS/MS experiments often miss low-abundance peaks, but with All Ions MS/MS experiments, all the ions from the source are directed to the collision cell for fragmentation. Data analysis software then uses the MS/MS spectra available in the PCDL to confidently extract compounds present in the sample.

Agilent All Ions MS/MS is even more powerful in combination with ion mobility because the ion drift time provides an additional dimension of separation where sample complexity can be further reduced to enhance detection of low-level compounds. The benefit: less ambiguity in identifying compounds, better detection limits for trace-level compounds.

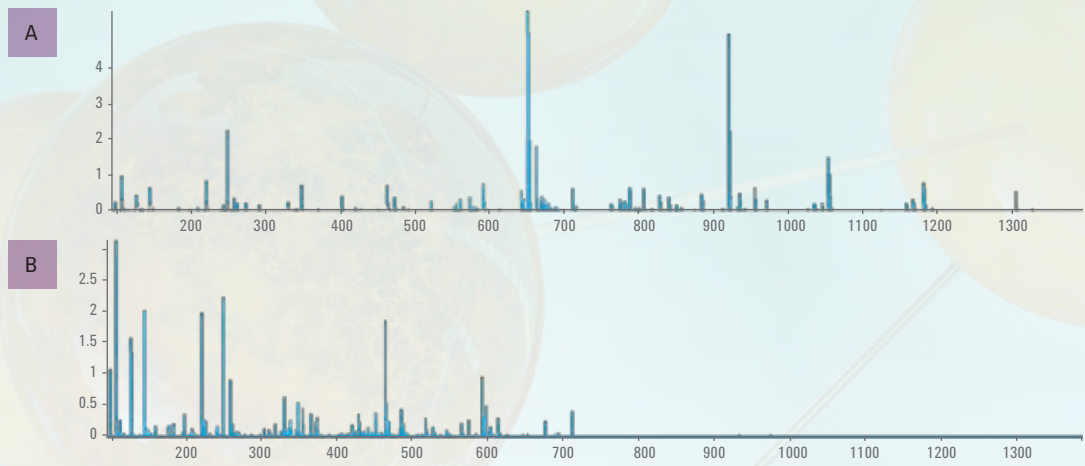
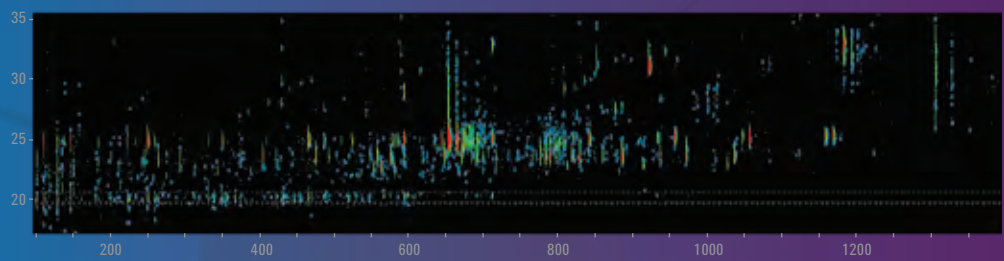
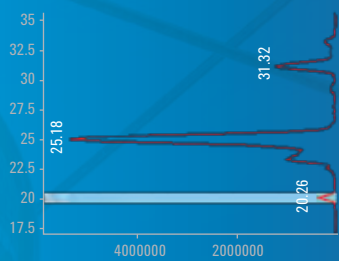

Agilent All Ions MS/MS is used to identify low-level peptides in a complex serum mixture. The starred peak in the LC separation had 6 to 7 peptide components seen separated in drift time heat map above. These could not be detected and identified using just LC and MS. A) Sum of fragment ion spectrum at 30 V across the starred peak. B) Drift separated fragment ion spectrum of the triple charged HLVDEPQNLIK peptide at 20.26 ms.

DISCOVER THE DIFFERENCE

Separate Molecules By Size And Shape

Collision cross-section (CCS) values—a measure of the size and shape of compounds—are useful for characterizing polymers, proteins, peptides, lipids, biopharmaceuticals, and so on. For these studies, CCS values often help distinguish between various forms of isomers or structurally similar molecules or complexes.

CCS values are derived from ion mobility measurements and can be directly calculated in the uniform field drift tube, thanks to the unique design used by Agilent.

With the Agilent 6560, you'll be able to routinely achieve CCS measurements within <2% accuracy. The system's uniform field drift tube provides excellent control of experimental parameters (pressure, temperature, electric field), which the system maintains during the mobility experiment.

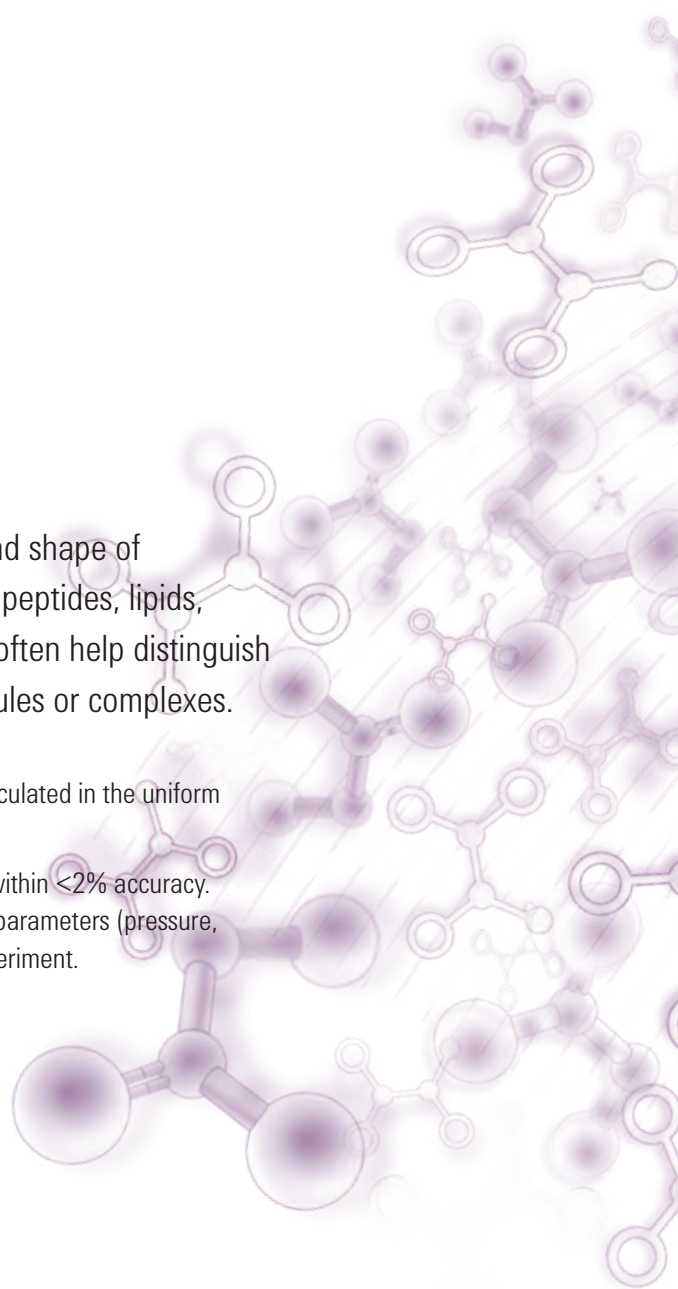

Analyte		Mass [Da]	CCS Agilent IM-MS ¹ [Å ²]	CCS Literature ² [Å ²]	Percent Difference
Tetrapropylammonium	TAA3	186.36	144.1 ± 0.7	143.80	0.22%
Tetrabutylammonium	TAA4	242.46	166.6 ± 0.9	166.00	0.36%
Tetrapentylammonium	TAA5	298.57	190.1 ± 1.0	190.10	0.02%
Tetrahexylammonium	TAA6	354.68	213.5 ± 1.0	214.00	0.23%
Tetraheptylammonium	TAA7	410.78	236.4 ± 0.4	236.80	0.17%
Tetraoctylammonium	TAA8	466.54	256.6 ± 0.7	258.30	0.64%
Tetradecylammonium	TAA10	579.11	293.5 ± 0.7	-	-
Tetradodecylammonium	TAA12	691.32	319.0 ± 0.9	-	-
Tetrahexadecylammonium	TAA16	915.04	361.5 ± 0.9	-	-
Tetraoctadecylammonium	TAA18	1027.16	379.0 ± 1.7	-	-

1. May, J.C., Goodwin, C.R., Lareau, N.M., Leaptrot, K.L., Morris, C.B., Kurulugama, R.T., Mordehai, A., Klein, C., Barry, W., Darland, E., Overney, G., Imatani, K., Stafford, G.C., Fjeldsted, J.C., McLean, J.A. *Anal Chem* 2014, (Feb 18, 2014; 2107-2116) Conformational Ordering of Biomolecules in the Gas-Phase: Nitrogen Collision Cross-Sections Measured on a Prototype High Resolution Drift Tube Ion Mobility-Mass Spectrometer.

2 Campuzano, I., Bush, M. F., Robinson, C. V., Beaumont, C., Richardson, K., Kim, H., Kim, H. I. *Anal Chem* 2012, 84(2) 1026-33. Structural Characterization of Drug-like Compounds by Ion Mobility Mass Spectrometry.



VISUALIZE THE DATA

Masshunter Software Helps You See Clearly

To maximize the analytical utility of this system, Agilent has enhanced MassHunter software tools to visualize ion mobility data. This software enables you to interrogate mobility/mass domain data and easily determine collision cross-section values with precision.

THE FASTEST, EASIEST WAY TO UNDERSTAND YOUR DATA

Here's where Agilent MassHunter software really shines:

- **Quality graphics** Clearly see (and present) your data.
- **Intuitive, interactive, linked navigation** Easily interpret the details you need to see.
- **Simultaneous viewing of all three dimensions of separation** Get unobscured views of your data in context, helping to visualize the multi-dimensional space.
- **Easy filtering of data in any (or all) dimensions** Reduce complexity for interactive viewing and for automated processing.
- **Dynamic data display** Compare data from anywhere in the data file, or between data files.
- **Simple, direct calculation of collision cross-section values** No need for compound class-specific calibration.

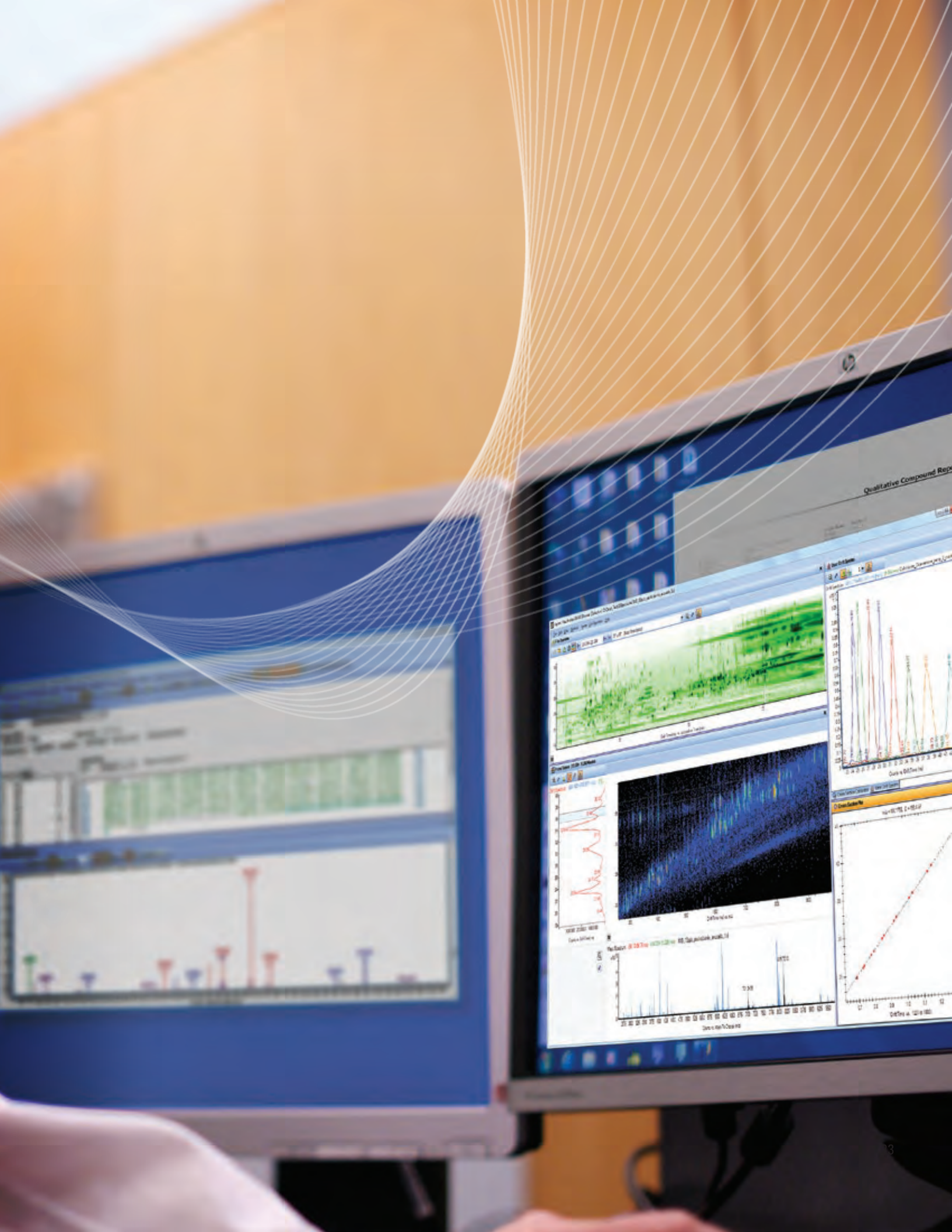

Learn more

www.agilent.com/chem/imq-tof

Contact an Agilent Representative

agilent.com/chem/quote

U.S. and Canada

1-800-227-9770

agilent_inquiries@agilent.com

Europe

info_agilent@agilent.com

Asia Pacific

inquiry_lsca@agilent.com

This information is subject to change without notice.

© Agilent Technologies, Inc. 2014, 2017
Printed in the USA March 16, 2017
5991-3640EN



Agilent Technologies