

Agilent InfinityLab

Quick Change Valve G4239C Instructions

Technical Information about the Agilent Valve Kit G4239C.

Contents

Typical Applications 2

Multicolumn Selection 2

Method Development 3

Delivery Checklist 3

Install the Valve Heads 8

Remove the Transportation Lock and the Valve Dummy 8

Install the Valve Head and Connect Capillaries 10

Install the Capillaries 14

Setup Examples 16

Valve Specifications 19

Valve Parts 19



Typical Applications

Multicolumn Selection

Advantages

- Increase productivity
- Higher instrument up-time

The valve facilitating quick changes allows the selection between up to eight different stationary phases for a variety of applications, or the usage of identical stationary phases in columns with different dimensions for either faster run-times (short columns) or higher resolution (long columns) or for loading studies with different internal diameters.

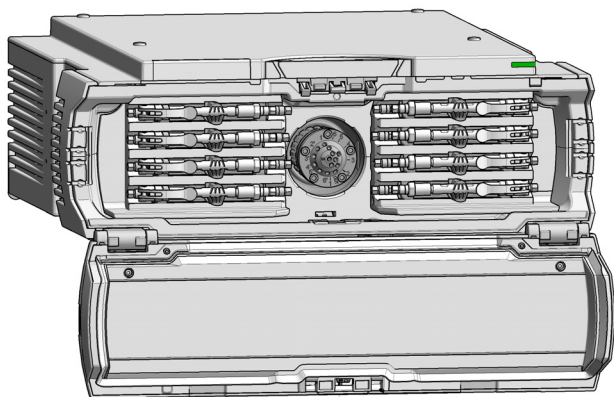

Figure 1 The G7116B 1290 Infinity II Multicolumn Thermostat equipped with an InfinityLab Quick Change 8-column selector valve head

Method Development

Advantages:

- Faster method development
- Automated method development possible

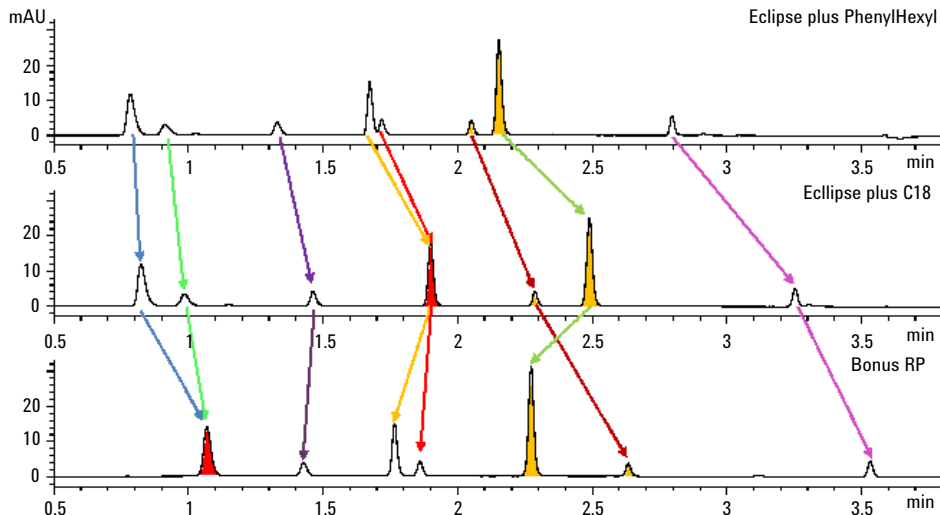

Figure 2 Totally different chromatographic results by using the same sample but three different stationary phases

Delivery Checklist

Delivery Checklist:

p/n	Description
5067-4233	8-Column Selector, 1300 bar
5067-4248	Capillary Kit, 0.12 mm, 8-column sel, short columns, PC-HEX (OPTIONAL)
5067-6697	Capillary Kit, 0.12 mm, 8-column sel, long columns, PC-HEX (OPTIONAL)
5067-6723	Capillary kit 0.17 mm, 8-column sel, long columns, QC-HEX (OPTIONAL)
5067-6724	Capillary kit 0.17 mm, 8-column sel, short columns, QC-HEX (OPTIONAL)

Capillary Kit, 0.12 mm, 8-column sel, short columns, PC-Hex (5067-4248):

#	p/n	Description
1	5500-1202	Capillary ST 0.12 mm x 500 mm M4-SL PS-PS Autosampler to valve
8	5500-1199	Capillary ST 0.12 mm x 130 mm M4-SL PS-PS Valve to heat exchanger
8	5500-1200	Quick Turn Capillary ST 0.12 mm x 130 mm SL/M Column to valve
1	5063-6591	PEEK Fittings 10/PK Column outlet
8	5500-1201	Capillary ST 0.12 mm x 105 mm SL-- PS-LS Heat exchanger (ps-SL) to column (long socket - use G1314-68703)
8	G1314-68703	Cap fitting kit special Column inlet connection fitting
1	5500-1203	Capillary ST 0.12 mm x 280 mm M4-SL PS-PS Valve (ps-M4) to detector (ps-SL)
1	5500-1204	Capillary ST 0.12 mm x 150 mm M4-M4 PS-PS Valve to valve (column bypass)
1	5023-2504	Hex driver SW-4 slitted Tool for M4 fittings
8	G7116-60015	Quick Connect Heat Exchanger Standard Low dispersion heat exchangers
1	G1375-87326	Waste tube Waste tube incl. M4 PEEK fitting
3	5067-6141	M4 Blank nut for plugging unused valve ports
8	G7116-68003	Column Holder Clips (2/Pk)
1	5043-0915	Fitting mounting tool
1	5063-6591	PEEK Fittings 10/PK
1	5067-6654	Number Kit 1-8 colored

Capillary Kit, 0.12 mm, 8-column sel, long columns, PC-HEX (5067-6697):

#	p/n	Description
1	5023-2504	Hex driver SW-4 slitted
8	5500-1201	Capillary ST 0.12 mm x 105 mm SL-- PS-LS heat exchanger to column
8	G1314-68703	Cap fitting kit special Fitting Column Inlet
3	5067-6141	M4 Blank nut
16	5500-1286	Capillary ST 0.12 mm x 340 mm SL/M 16 valve to heat exchanger / column to valve
1	5500-1272	Capillary ST 0.12 mm x 800 mm M4-SL 1 ALS to valve
1	5500-1203	Capillary ST 0.12 mm x 280 mm M4-SL PS-PS valve to detector
1	5500-1204	Capillary ST 0.12 mm x 150 mm M4-M4 PS-PS valve to valve bypass
8	G7116-60015	Quick Connect Heat Exchanger Standard
8	G7116-68003	Column Holder Clips (2/Pk)
1	G1375-87326	Waste tube valve to waste
1	5062-8541	Fingertight fitting long, 10/pk
1	5067-6654	Number Kit 1-8 colored

Capillary kit 0.17 mm, 8-column sel, long columns, QC-HEx (5067-6723):

#	p/n	Description
1	5023-2504	Hex driver SW-4 slitted
8	5500-1193	Capillary ST 0.17 mm x 105 mm, long socket Heat exchanger to column
8	G1314-68703	Cap fitting kit special Fitting column inlet
3	5067-6141	M4 Blank nut
17	5067-5108	SST-Capillary 340x0.17 mm ps-ns SW-M4 Valve to heat exchanger / column to valve
1	5067-5120	SST Cap. 0.17 mm ID 700 mm SW-1/16/M4 Autosampler to valve
1	5067-5108	SST-Capillary 340x0.17 mm ps-ns SW-M4 Valve to detector
1	5067-4737	Capillary ST 0.17 mm x 150 mm M/M Valve to valve bypass
8	G7116-60051	Quick-Connect Heat Exchanger Large ID
8	G7116-68003	Column Holder Clips (2/Pk)
1	G1375-87326	Waste tube Valve to waste
1	5062-8541	Fingertight fitting long, 10/pk
1	5065-4454	Fitting screw long, front and back ferrules 10/pk
1	5067-6654	Number Kit 1-8 colored

Capillary kit 0.17 mm, 8-column sel, short columns, QC-HEX (5067-6724):

#	p/n	Description
8	G7116-60051	Quick-Connect Heat Exchanger Large ID
8	G7116-68003	Column Holder Clips (2/Pk)
1	5067-6188	Capillary ST 0.17 mm x 500 mm SL-M4 PS-PS Autosampler to valve
8	5067-5109	Capillary ST 0.17 mm x 90 mm SL/M Valve to heat exchanger
8	5067-4746	Capillary ST 0.12 mm x 250 mm SLV/M long column to valve
8	5500-1200	Quick Turn Capillary ST 0.12 mm x 130 mm SL/M Short column to valve
1	5063-6591	PEEK Fittings 10/PK Column outlet
8	5500-1193	Capillary ST 0.17 mm x 105 mm, long socket Heat exchanger to column
1	5500-1203	Capillary ST 0.12 mm x 280 mm M4-SL PS-PS Valve to detector
1	5500-1204	Capillary ST 0.12 mm x 150 mm M4-M4 PS-PS Valve to valve (column bypass)
2	5065-4454	Fitting screw long, front and back ferrules 10/pk
1	5023-2504	Hex driver SW-4 slitted
1	5067-6141	M4 Blank nut
1	G1375-87326	Waste tube
1	5067-6654	Number Kit 1-8 colored

Capillary & Fitting Information

- M4 = fitting thread size for micro valve ports
- PS = pre-swaged fitting
- NS = non-swaged fitting
- SL = fitting screw long
- LS = long capillary socket (required for special fittings as the A-Line Quick Turn Fittings)

Install the Valve Heads

The valve drives are factory-installed in the Multicolumn Thermostat. The valve heads are interchangeable and can be easily mounted.

At the first installation, the transportation lock and the dummy valve have to be removed, see [“Remove the Transportation Lock and the Valve Dummy”](#) on page 8. The valve heads can be installed by mounting the valve heads onto the valve drives and fastening the nut manually (do not use any tools).

Be sure that the guide pin snaps into the groove of the valve drive thread.

NOTE

The valves are mounted on pull-out rails to allow easy installation of capillaries. Push the valve gently into its housing until it snaps into the inner position, push it again and it slides out.

When all capillaries are installed, push the valve back into its housing, see [“Install the Valve Head and Connect Capillaries”](#) on page 10.

Remove the Transportation Lock and the Valve Dummy

The following procedure demonstrates the necessary steps for installing the valve head to the valve drive of a Multicolumn Thermostat (MCT).

For the installation of a valve head to a G1170A Valve Drive you can ignore the steps that describe the MCT features of the transportation lock and spring loaded valve drive.

- 1 Switch off the module.

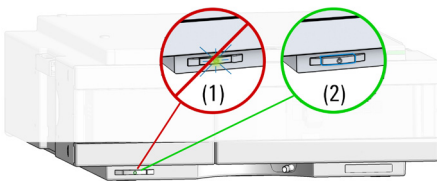

- 2 When unscrewing the transportation lock, push it back until the last screw is removed - the valve rail is spring-loaded.

3 Press on the valve dummy (1.) to release it (2.) (spring-loaded valve rail).

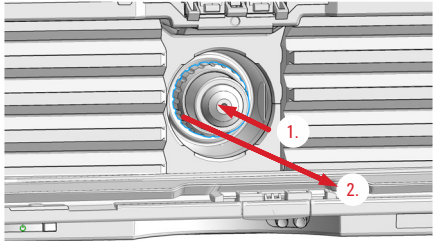

4

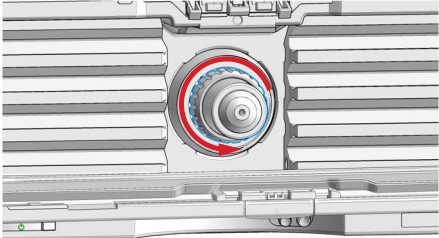

5

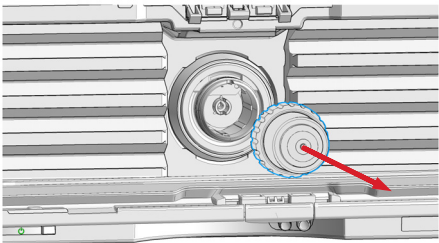

Install the Valve Head and Connect Capillaries



For bio-inert modules use bio-inert parts only!

CAUTION

The valve actuator contains sensitive optical parts, which need to be protected from dust and other pollution. Pollution of these parts can impair the accurate selection of valve ports and therefore bias measurement results.

- Always install a valve head for operation and storage. For protecting the actuator, a dummy valve head can be used instead of a functional valve. Do not touch parts inside the actuator.
-

CAUTION

Column Damage or Bias Measurement Results

Switching the valve to a wrong position can damage the column or bias measurement results.

- Fit the lobe to the groove to make sure the valve is switched to the correct position.
-

CAUTION

Valve Damage

Using a low pressure valve on the high pressure side can damage the valve.

- When using multiple column compartments as part of a method development solution, make sure that the high pressure valve head is connected to the autosampler and the low pressure valve head is connected to the detector.
-

CAUTION

Sample degradation and contamination of the instrument

Metal parts in the flow path can interact with the bio-molecules in the sample leading to sample degradation and contamination.

- For bio-inert applications, always use dedicated bio-inert parts, which can be identified by the bio-inert symbol or other markers described in this manual.
- Do not mix bio-inert and non-inert modules or parts in a bio-inert system.

CAUTION

Wrong combination of fitting with valve

The InfinityLab Quick Turn fitting (5067-5966) is not compatible with the G5639A Bio-inert 4-Column Selector Valve. Misuse can lead to extra dead volume and leaks.

- As fitting, use UHP fitting (5067-5403) instead.

NOTE

For information about the compatibility mode of 800 bar valve heads see Information on RFID Tag Technical Note (01200-90134).

NOTE

For a correct installation of the valve head, the outside pin (red) must completely fit into the outside groove on the valve drive's shaft (red). A correct installation is only possible if the two pins (green and blue) on the valve head fit into their corresponding grooves on the valve drive's actuator axis. Their match depends on the diameter of the pin and groove.

NOTE

The tag reader reads the valve head properties from the valve head RFID tag during initialization of the module. Valve properties will not be updated, if the valve head is replaced while the module is on. Selection of valve port positions can fail, if the instrument does not know the properties of the installed valve.

NOTE

To allow correct valve identification, power off the valve drive for at least 10 s.

NOTE

For firmware requirements see Information on new RFID Tag Assembly Version Technical Note (01200-90133) which is included to each valve head.

The following procedure shows the valve head installation with an G7116A/B (MCT) module as an example. For other modules it is similar.

1 Insert the valve head into the valve shaft.

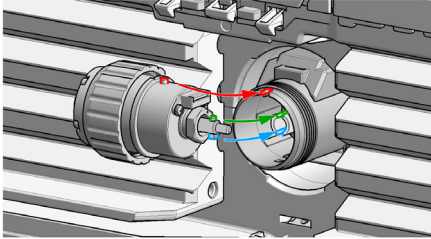

OR

If the outside pin does not fit into the outside groove, you have to turn the valve head until you feel that the two pins snap into the grooves. Now you should feel additional resistance from the valve drive while continuously turning the valve head until the pin fits into the groove.

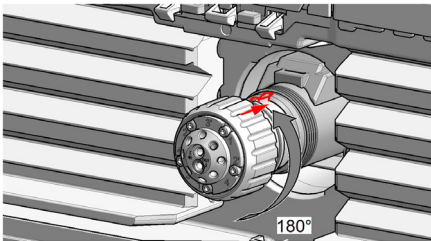
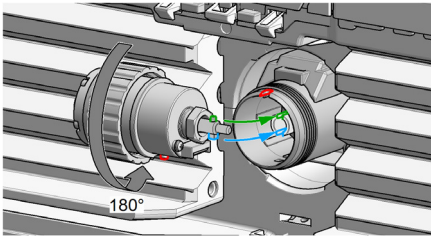

- 2** When the outer pin is locked into the groove, manually screw the nut onto the valve head.

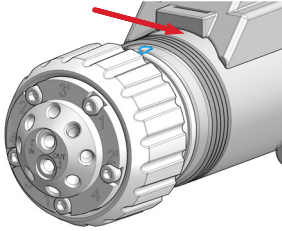

NOTE

Fasten the nut manually. Do not use any tools.

- 3** Install all required capillary connections to the valve.

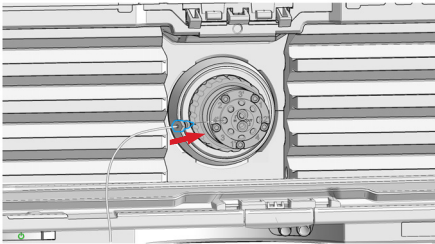

- 4** Push the valve head until it snaps in and stays in the rear position.

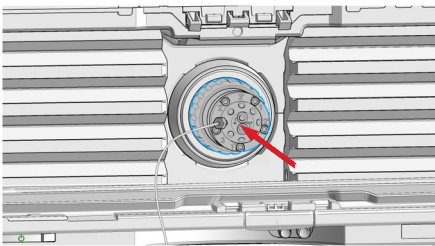

- 5** Power on or power-cycle your module, so the valve head gets recognized during module initialization.

Install the Capillaries

CAUTION

Damage to the rotor seal

Instant pressure release within the valve will lead to water jet effects that can harm internal parts of the valve. This pressure release typically happens if the valve gets switched under high pressure over unused or open channels.

→ Block all unused channels properly with the M4 blank nut.

NOTE

To minimize valve movement over open connections it is recommended to plumb the column connected channels in one row.

e.g.:

- channel 1 – column 1
 - channel 2 – column 2
 - channel 3 – column 3
 - channel 4 – column 4
 - channel 5 – blocked
 - channel 6 – blocked
 - channel 7 – waste
 - channel 8 – bypass
-

NOTE

The blank nuts are only required for the ports on the inner circle that connect the valve with the column inlet.

The capillary connections depend on the capillary kit that is in use. For details, see “[Delivery Checklist](#)” on page 3.

1 Install the in and out connectors.

- from sampler to the valve
- from valve to the detector

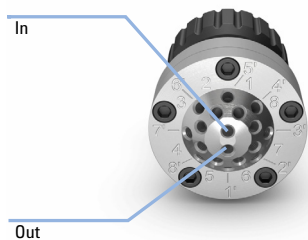

The *In* port is hydraulically connected to the column inlet ports 1-8 on the inner ring while the *Out* port connects to the column outlet ports 1`-8` on the outer ring.

2 Install the column inlet and outlet connections.

-
- *ports 1-8* for connections from valve to the heat exchanger
 - *ports 1`-8`* for connections from column outlet to valve
-

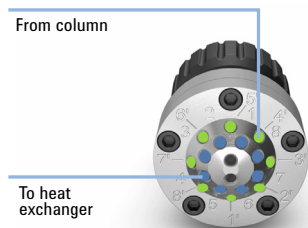

Setup Examples

1 Eight column selection

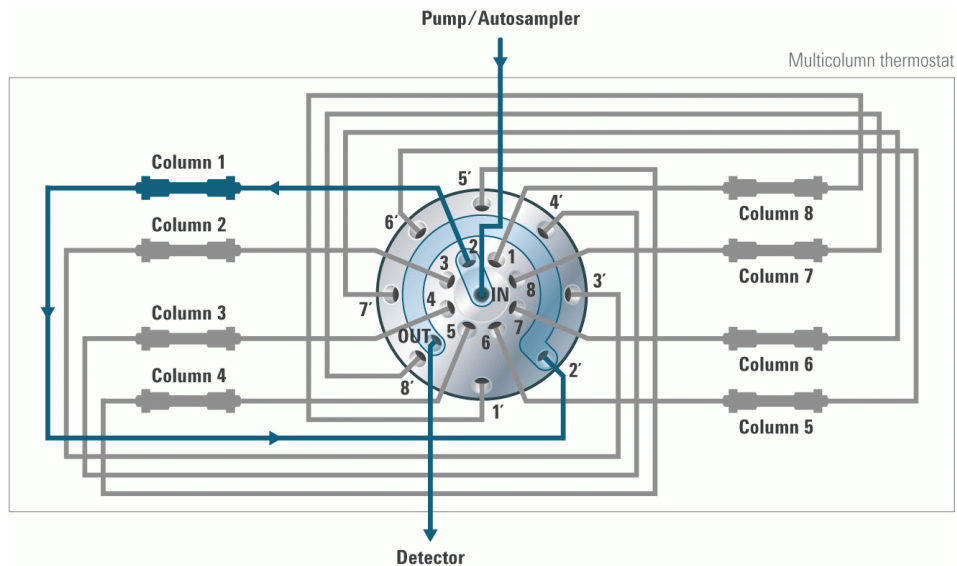

Figure 3 Hydraulic flow path schematics for an 8-column selection setup

2 Six column selection with purge line and valve- bypass

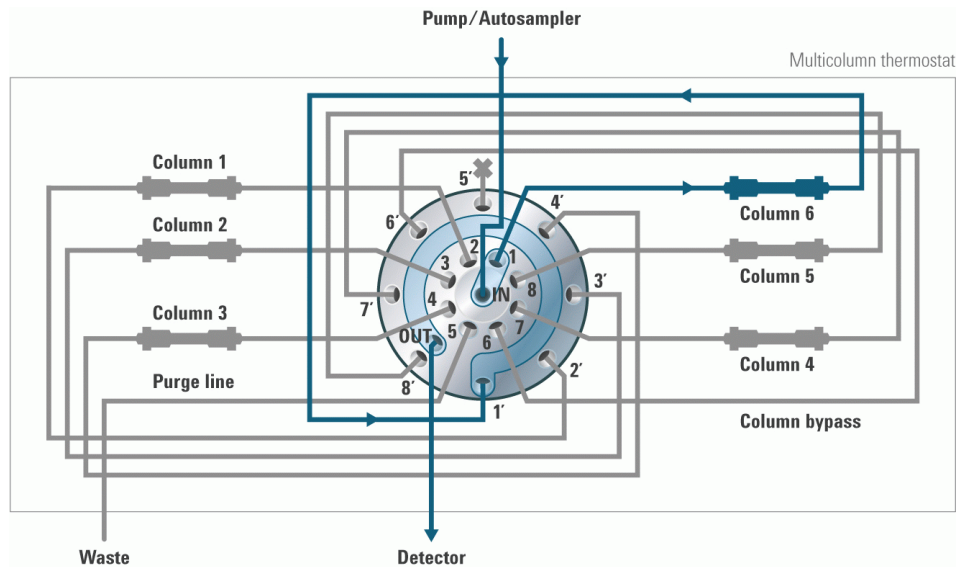

Figure 4 Hydraulic flow path schematics for 6-column selection setup with purge and valve bypass line.

3 The Kit 5067-6697 and 5067-6723 are for column selection of 8 long columns, i.e. longer than 150 mm. For this set-up a second MCT is required. In each MCT four columns are placed.

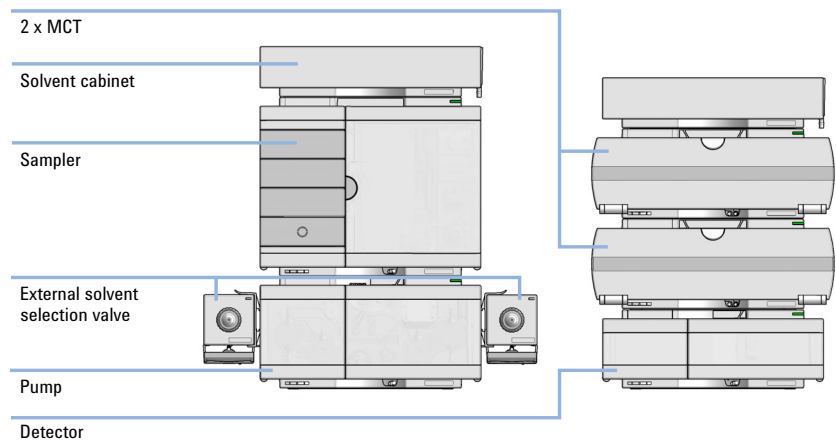

Figure 5 Example setup based on a 1290 Infinity II LC (with two MCT), two stack configuration

4 The plumbing is exactly the same as for the kit 5067-4248.

Valve Specifications

Table 1 G4239C (5067-4233), 8ps/18pt, 8-column selector, 1300 bar

Type	Specification
Maximum pressure	1300 bar
Typical application	8 column selection
Port size	Accepts M4 male threaded fittings
Liquid contacts	PEEK, Stainless Steel
pH range	0 – 14*

* incompatible with some mineral acids. For more information see Solvent Information.

Valve Parts

Valve	Rotor Seal	Stator Head	Bearing Ring	Stator Screws (Pack of 10)
8-Column Selector, 1300 bar (5067-4233)	PEEK, 5068-0200	5068-0199	1535-4045	5068-0089

Valve Head Parts

NOTE

The figure below illustrates replacement parts for the valve heads, with the 12ps/13pt Selector valve as an example. The valves can vary in their appearance and do not necessarily include all of the illustrated parts. Neither, every spare part is available for each flavor of the valve.

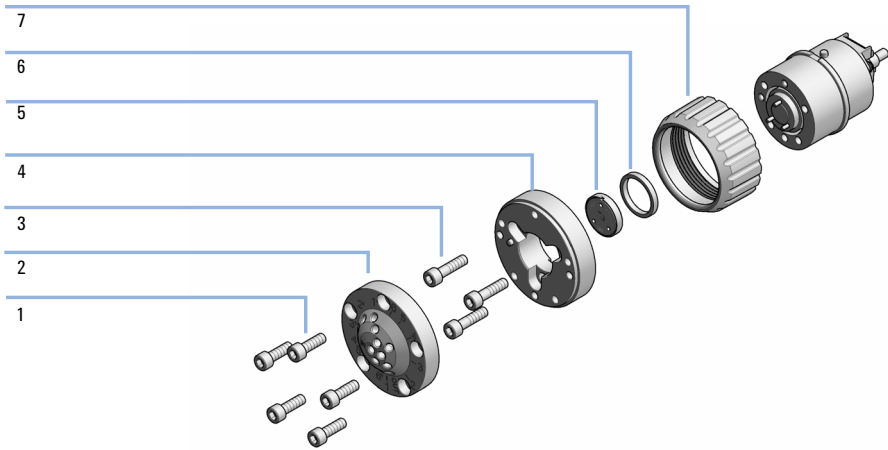

Figure 6 Valve Head Parts (example)

1	Stator screws
2	Stator head assembly
3	Stator ring screws (not available)
4	Stator ring (available for service only)
5	Rotor seal
6	Bearing ring
7	Spanner nut (available for service only)



G4239-90002

Part Number:
G4239-90002 Rev. C

Edition: 10/2018
Printed in Germany

© Agilent Technologies, Inc
2016-2018

Agilent Technologies, Inc
Hewlett-Packard-Strasse 8
76337 Waldbronn, Germany