



Making LC Connections

Mark Powell

24 October 2016

LC Connections

- Problems with improper connections
 - Source of leaks
 - **Mistaken for chromatography issues**
- Making connections can vary with technique
- Different manufacturers supply different types of fittings
- Capillary tubing choices
- Contribute to dispersion and extra-column volume

Dispersion Reduces HPLC Performance

What is dispersion?

- Original sample concentration being diluted as it is carried through the system plumbing (extra-column volume)

What increases dispersion?

- Connecting tubing that is too long
- Connecting tubing that is too large in diameter
- Connections that have gaps and form small mixing chambers

Extra-Column Volume

- Flow cell
- Heat exchanger
- Switching valve
- Needle seat
- Connecting capillaries

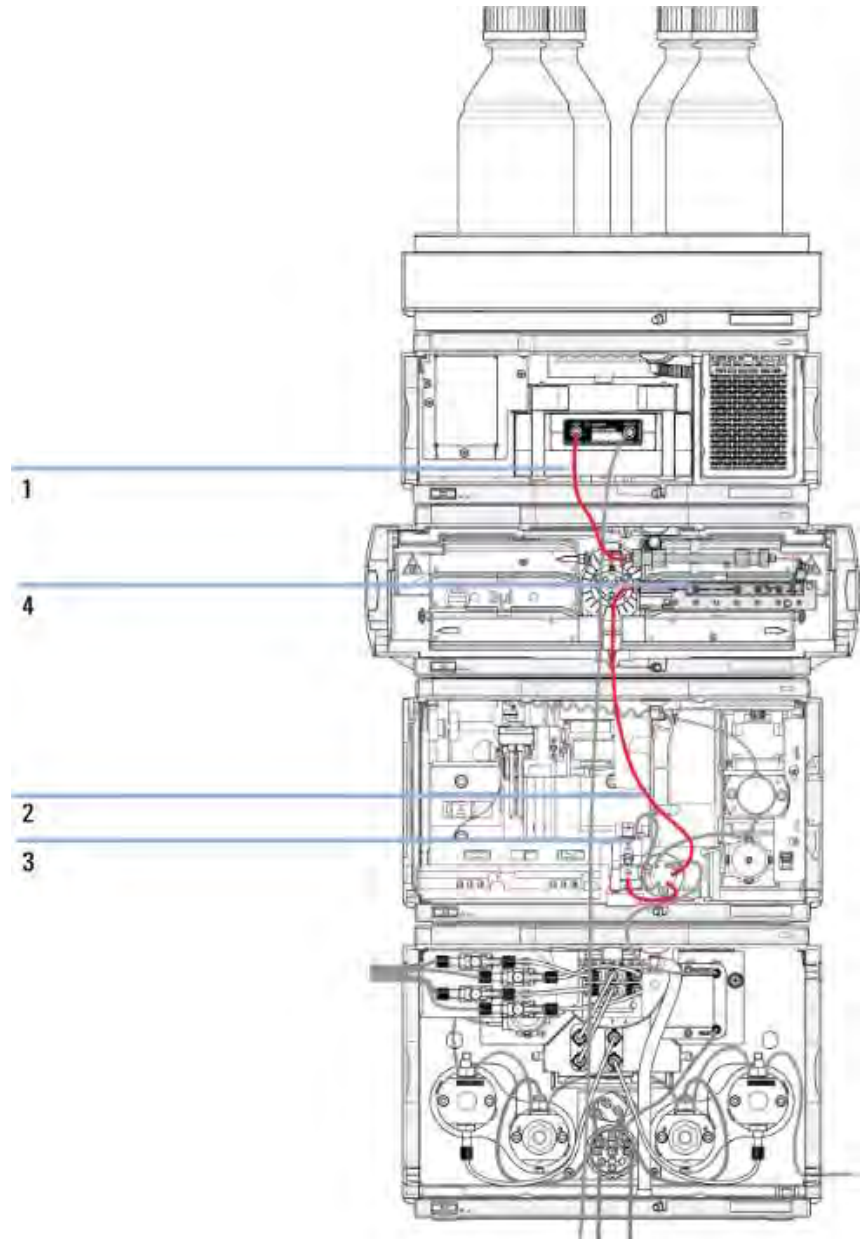

Extra-Column Volume

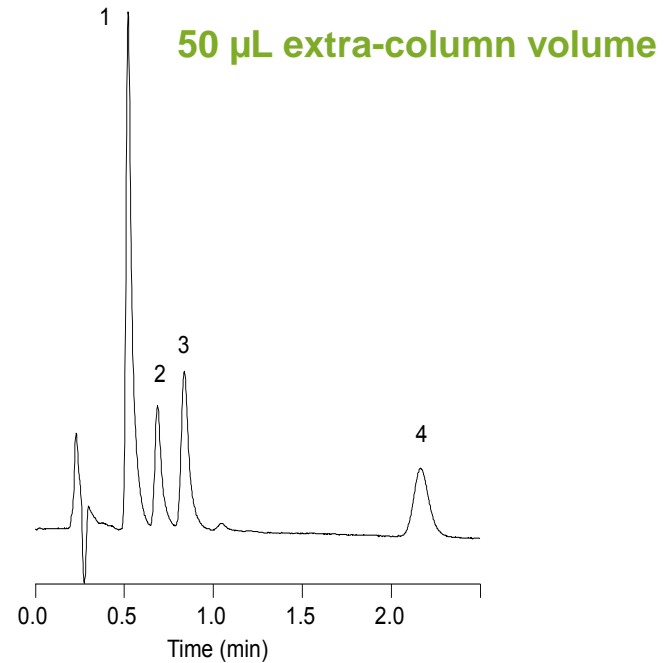
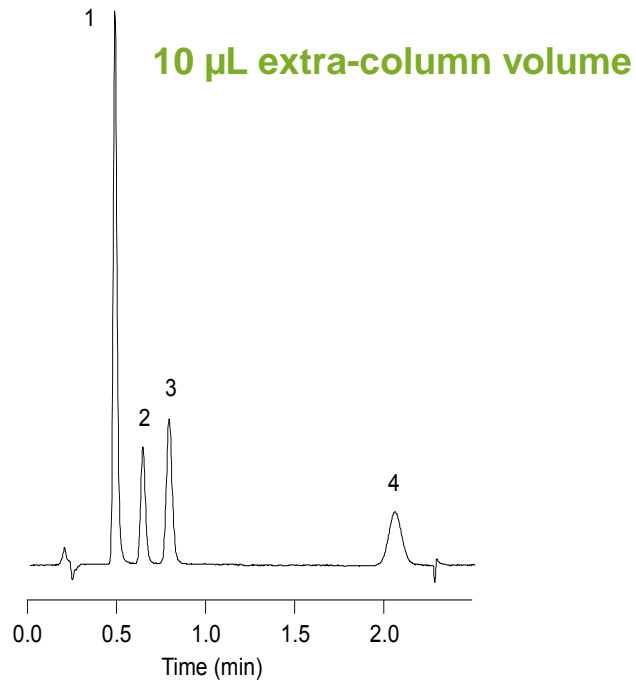

Column: StableBond SB-C18, 4.6 x 30 mm, 3.5 µm Mobile Phase: 85% H₂O with 0.1% TFA : 15% ACN Flow Rate: 1.0 mL/min
Temperature: 35°C Sample: 1. Phenylalanine 2. 5-benzyl-3,6-dioxo-2-piperazine acetic acid 3. Asp-Phe 4. Aspartame

Aris-Taylor Equation

peak dispersion in cylindrical tubing

$$\sigma_{v,\text{ext}}^2 = \frac{\pi d^4 L_{cap} u}{96D_m}$$

$\sigma_{v,\text{ext}}^2$ is the volume variance

d is the tubing diameter

L is the tubing length

u is the linear velocity of the liquid

D_m is the molecular diffusion coefficient

Tubing Volume

Tubing Length	10mm	50mm	100mm	150mm
Tubing ID	Volume	Volume	Volume	Volume
0.17mm (green)	0.227 uL	1.1uL	2.27 uL	3.3 uL
0.12mm (red)	0.113 uL	0.55uL	1.13 uL	1.65 uL



As Efficiency Increases Peak Width Decreases

System Dispersion Becomes More of a Factor

Columns: **Eclipse Plus C18**, as described below. Mobile Phase: A: water, B: MeOH, (15:85) Injection volume: 6 μ L
Temperature: 25 $^{\circ}$ C Flow: 1 mL/min. Detection: 310, 4 nm, 0.5 s response time, semi-micro flow cell, Sample: Sunscreens

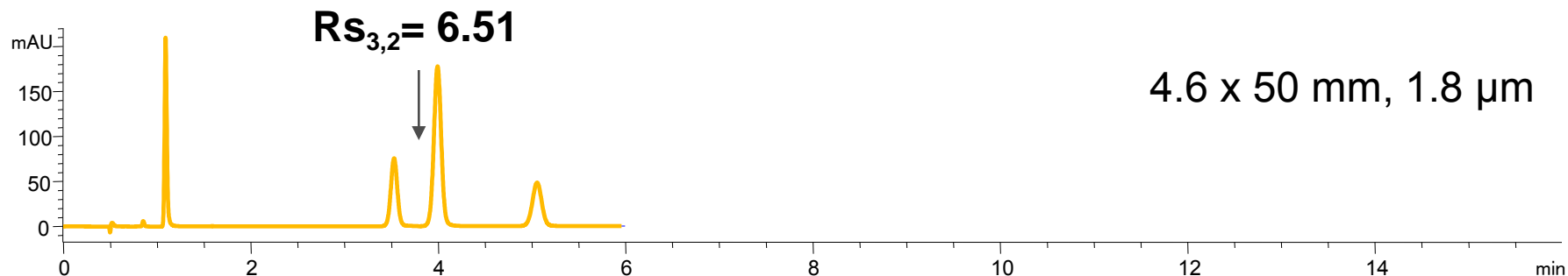
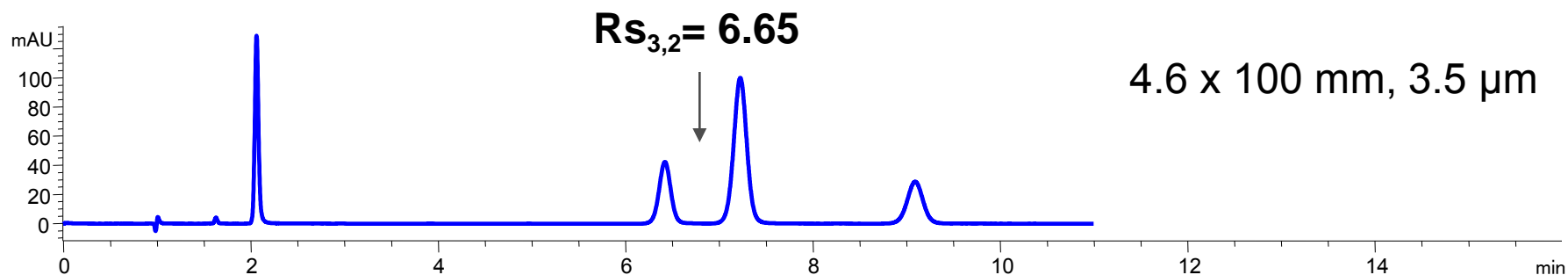
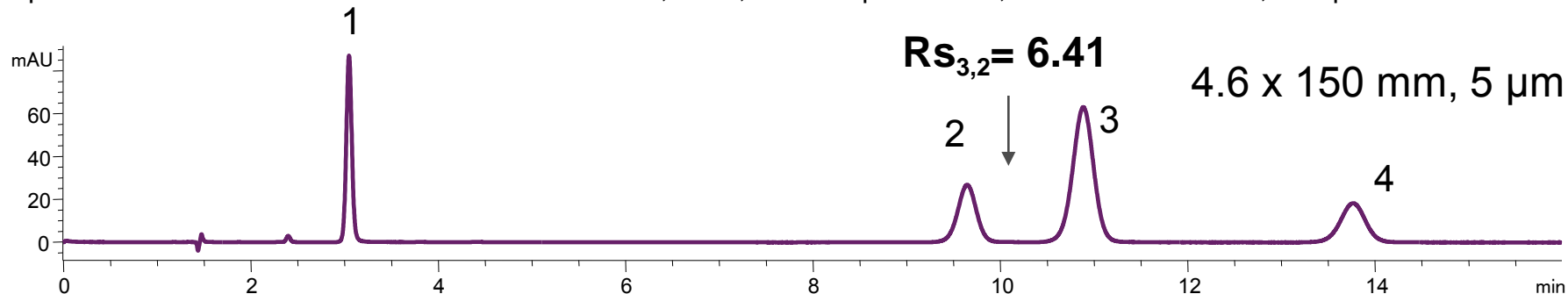

Approximate Extra Column Volume Limits for This 4.6mm i.d. Column Example

	5um	3.5um	1.8um
Peak (1) Width in uL	181	136	45
Injection (1/10 P.V.)	18	14	5
Extra Column (1/3 P.V.)	60	45	15
ECV minus Inj. Vol.	42	21	10
ECV Estimate for 2.1mm i.d. Column	8	4	2

Optimizing Connecting Tubing Volume For UHPLC Columns

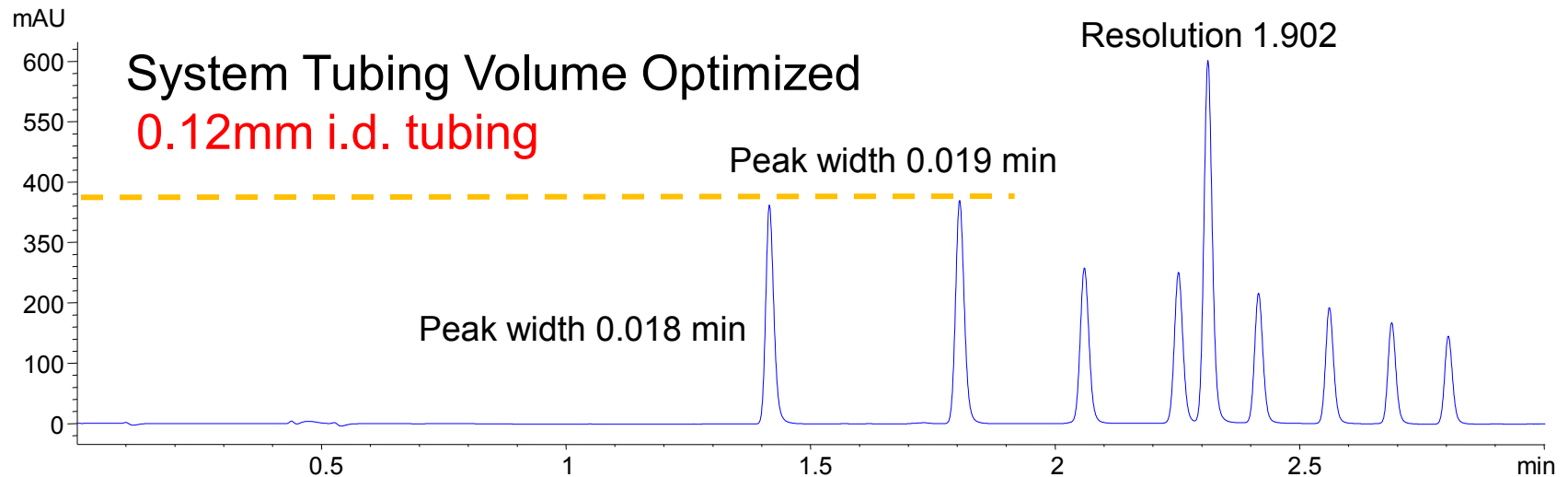
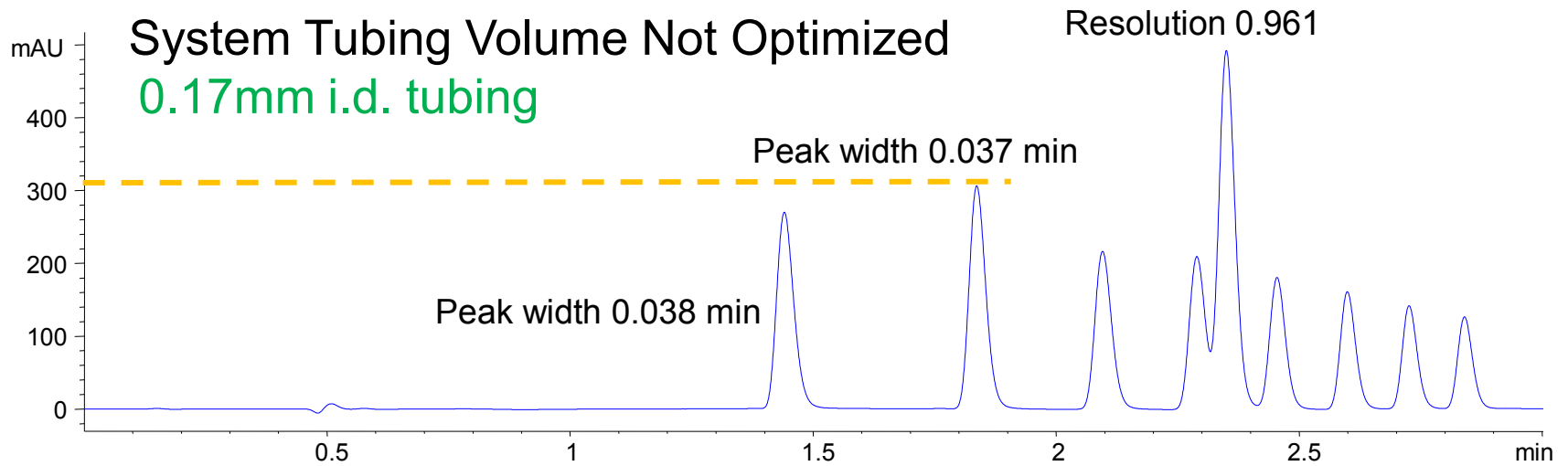

Stainless Steel vs. Polymeric Fittings

Stainless Steel:

- Agilent uses Swagelok type fittings with front and back ferrules
- Also available with a long nut

PEEK (<400 bar system pressure):

- Connections are changed frequently
- Connecting columns
- Pressure is less critical
- Fits on SS or PEEK tubing

Polyketone:

- Easy, hand tightened column connection
- Used up to 600 bar (PN: 5042-8957)
- Fits on SS Tubing



Type of Fittings



Swagelok

- Two piece ferrule
- Used on Agilent LCs
- Short nut
- Also available with long nut

Parker

- One piece ferrule
- Short nut
- Very similar to Swagelok

Waters

- Longer nut
- Used on Alliance systems

Types of Fittings

Swagelok

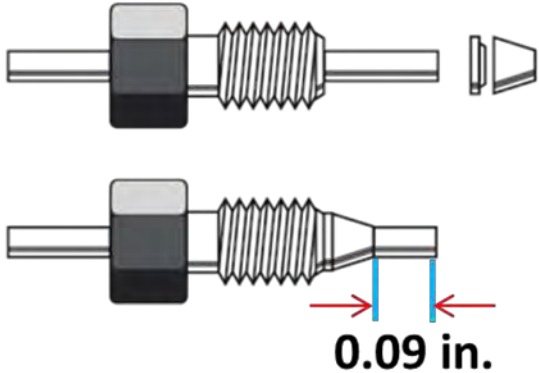

Waters

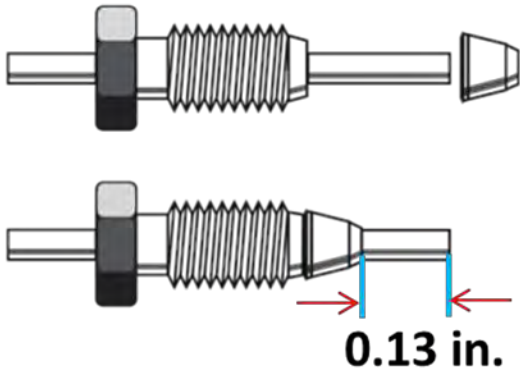

Valco

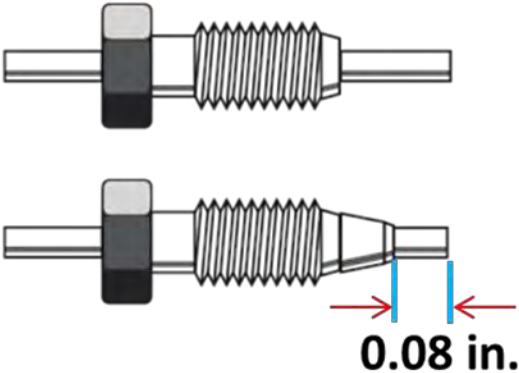

Parker

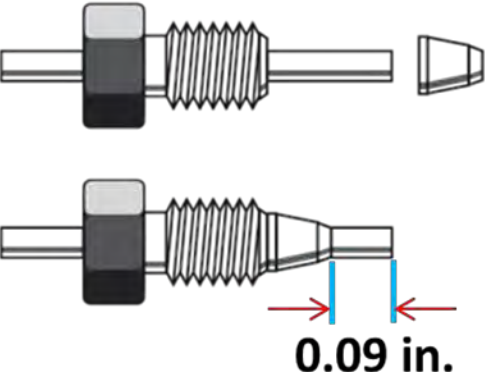

Rheodyne

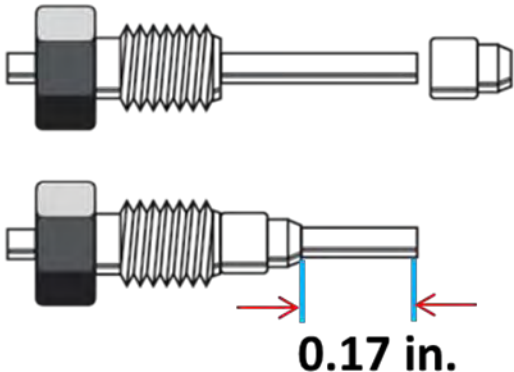

Upchurch

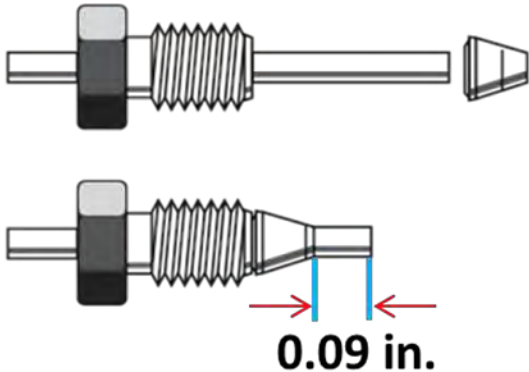

Potential Fittings Issues

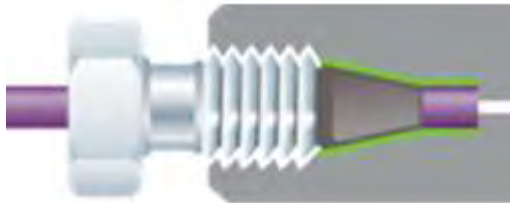

- Leak

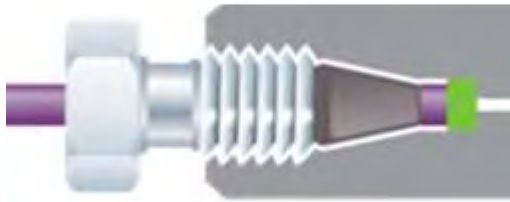

- Peak shape problem



- No dead volume

Fitting Mismatch

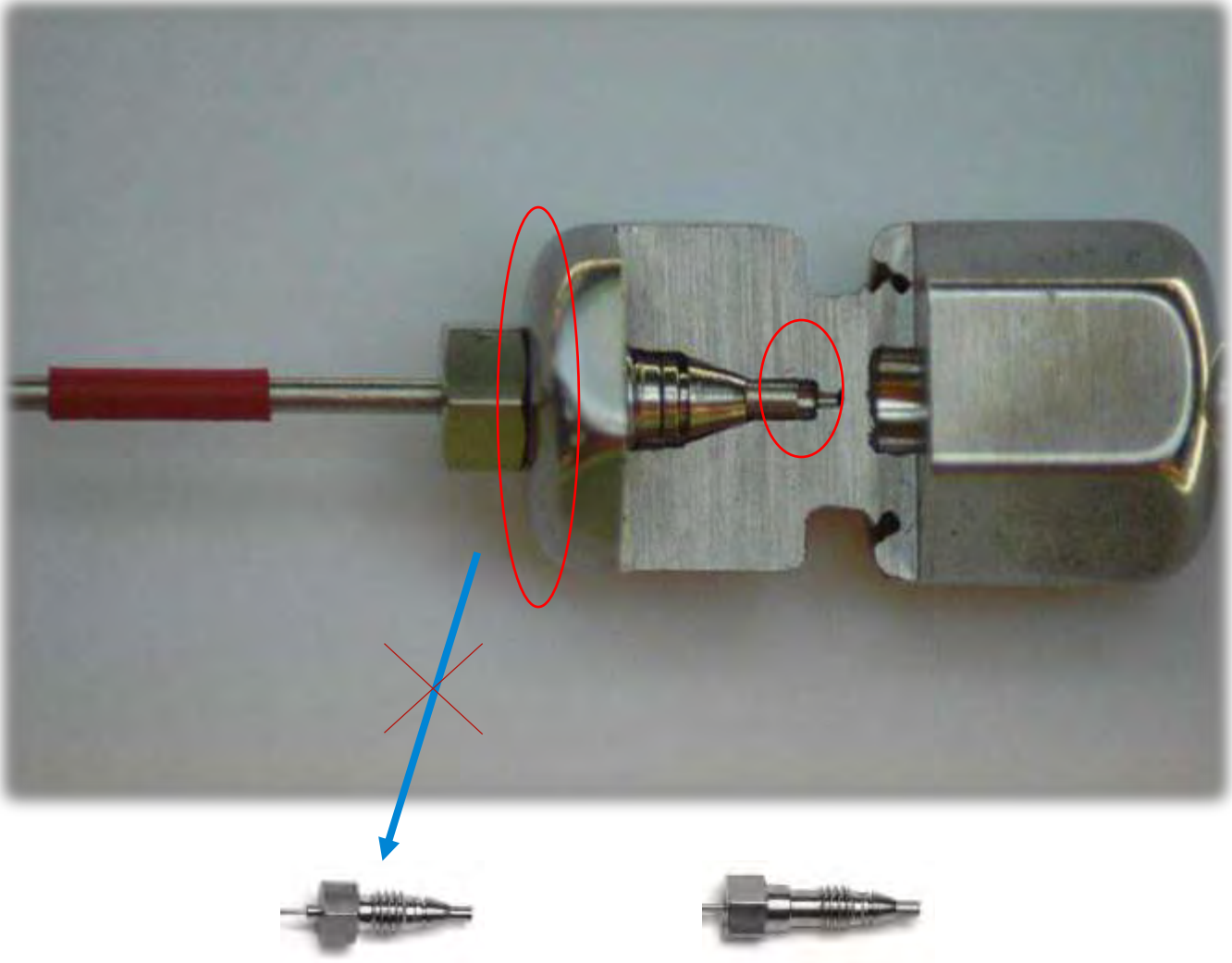

Proper Fit

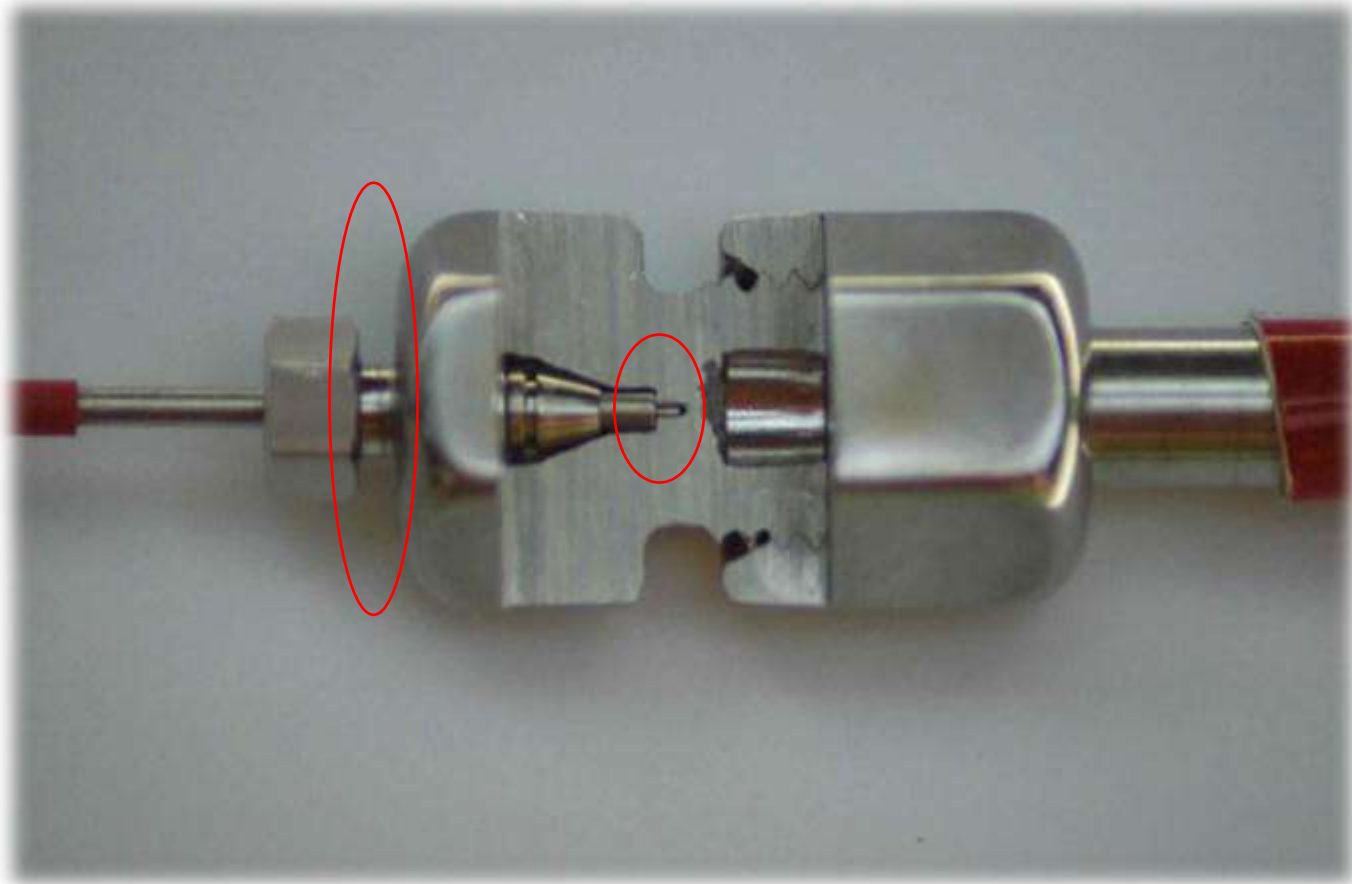

Fitting Mismatch

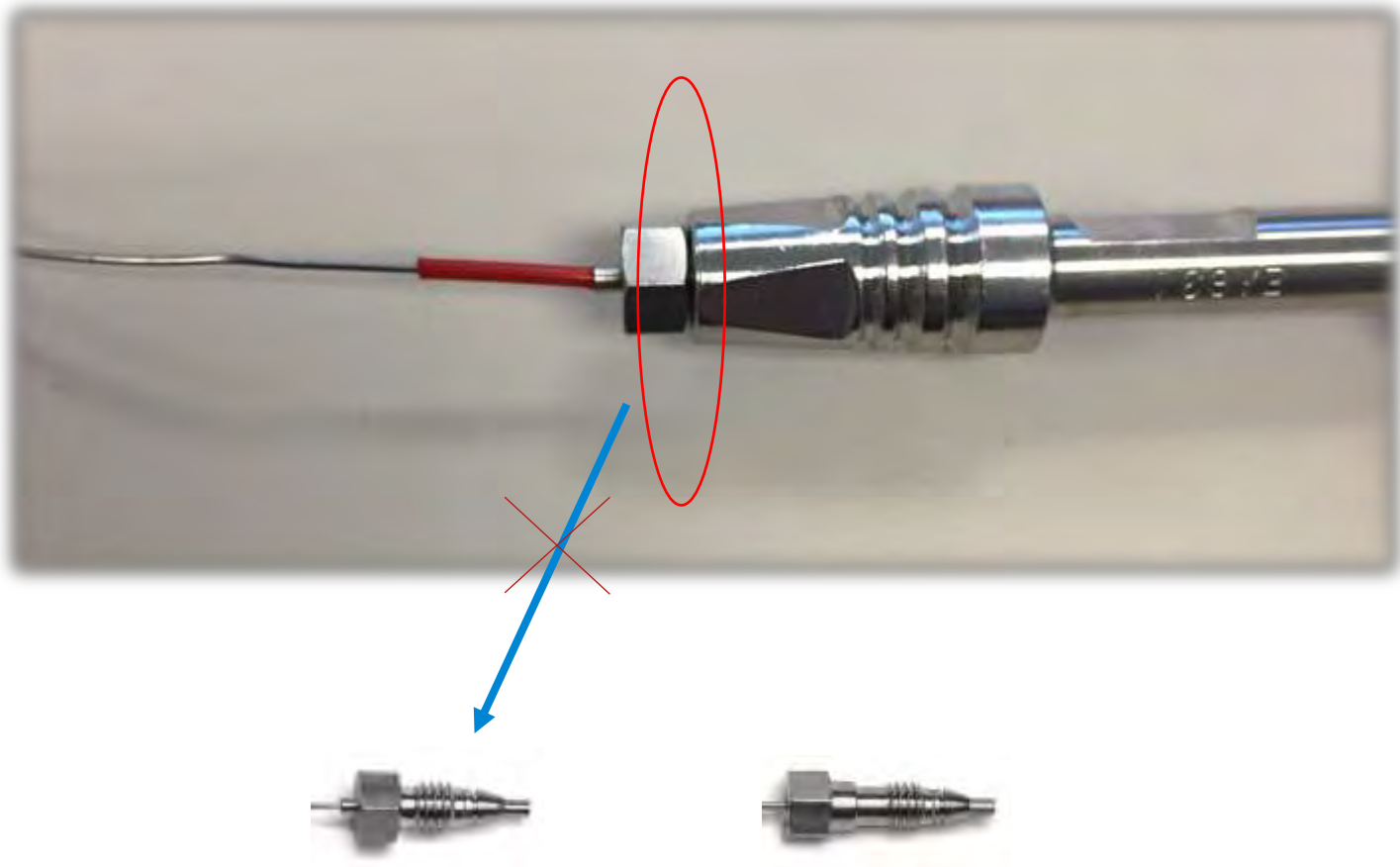

Proper Fit

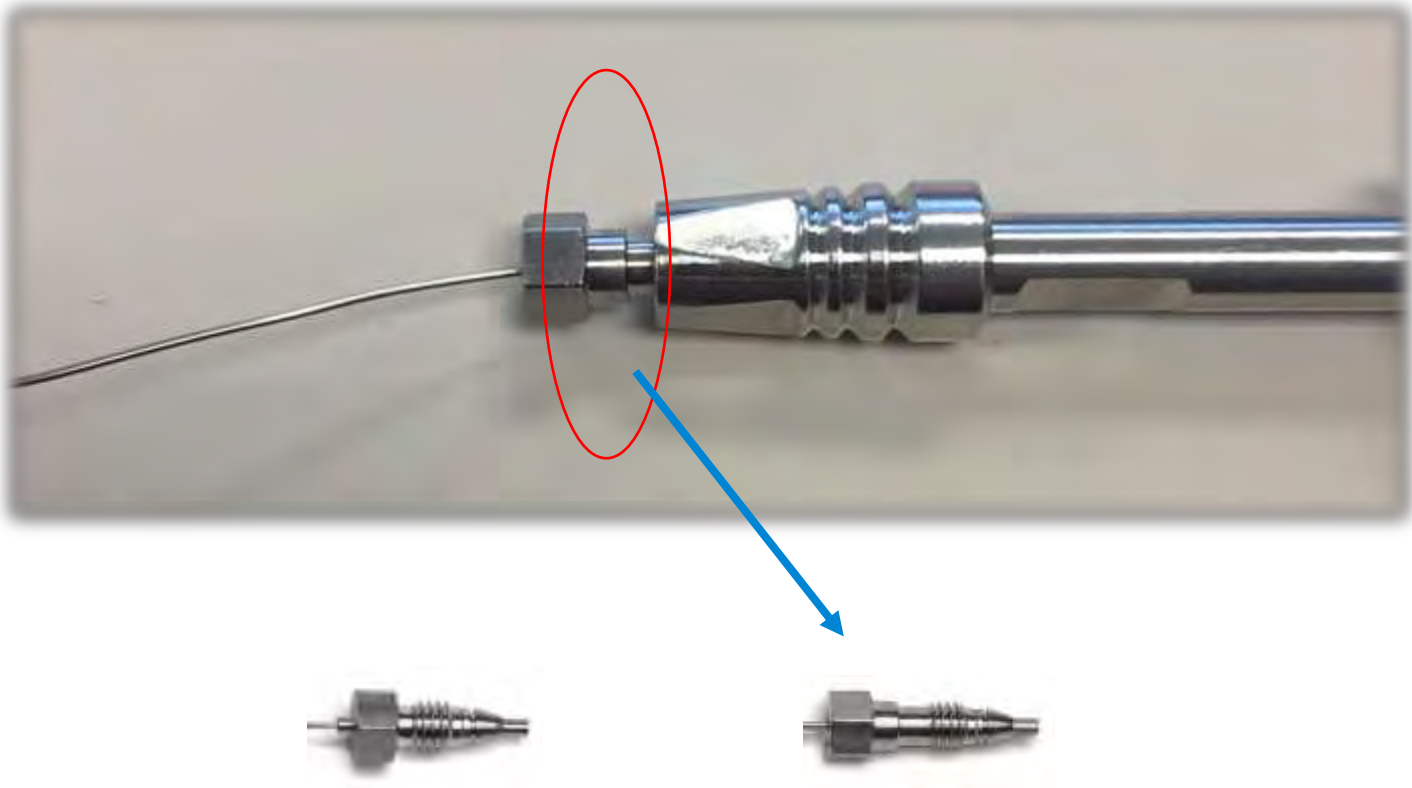

Polymeric Fittings

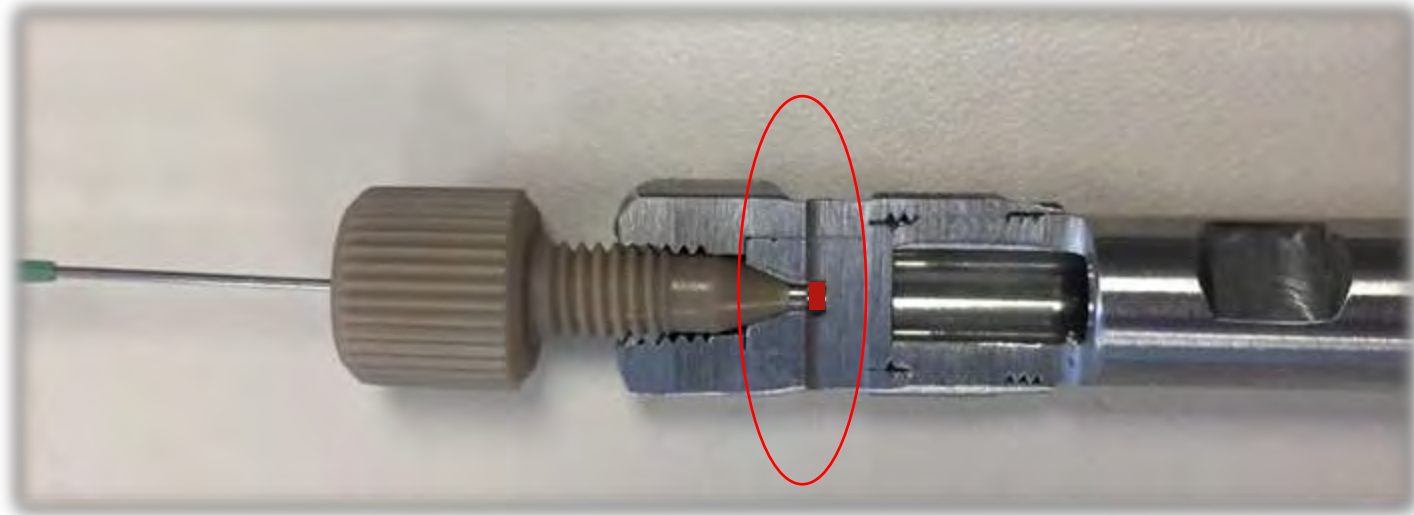

Peak Shape

— Zero-dead-volume fitting connection
— Fitting connection with dead volume

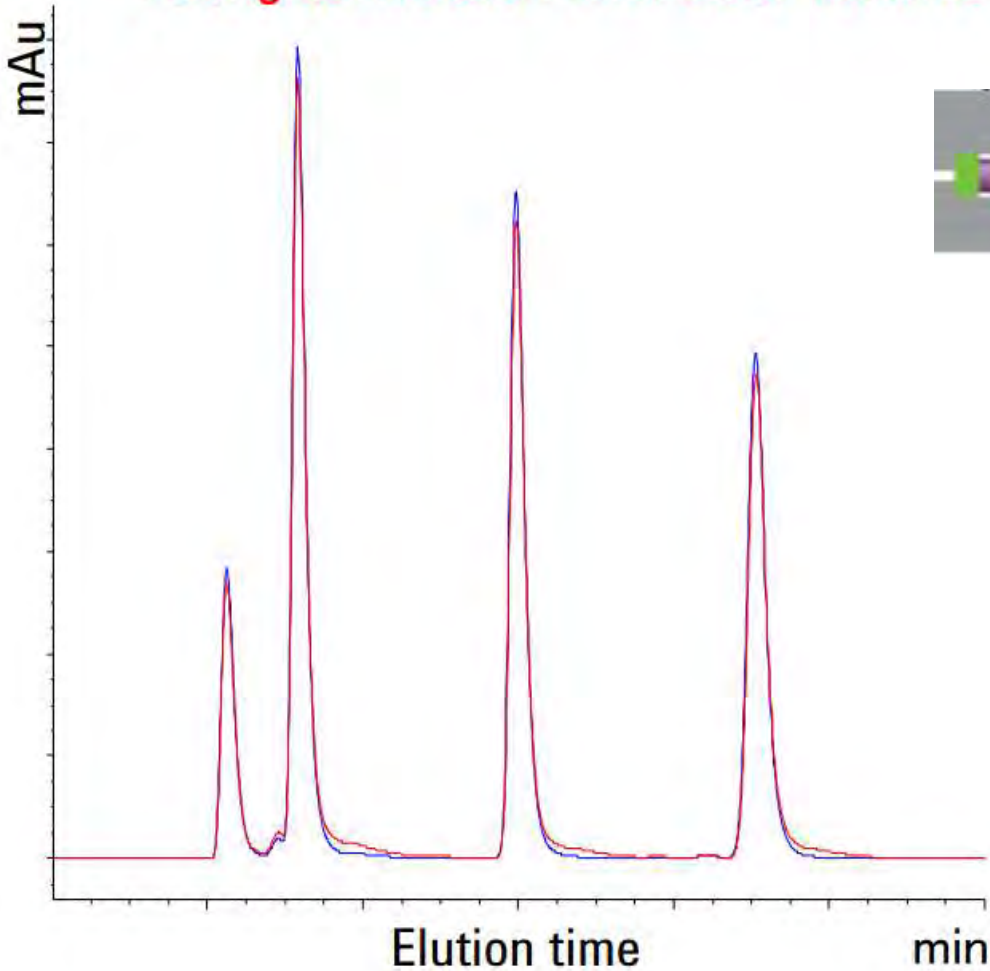

Peak Shape

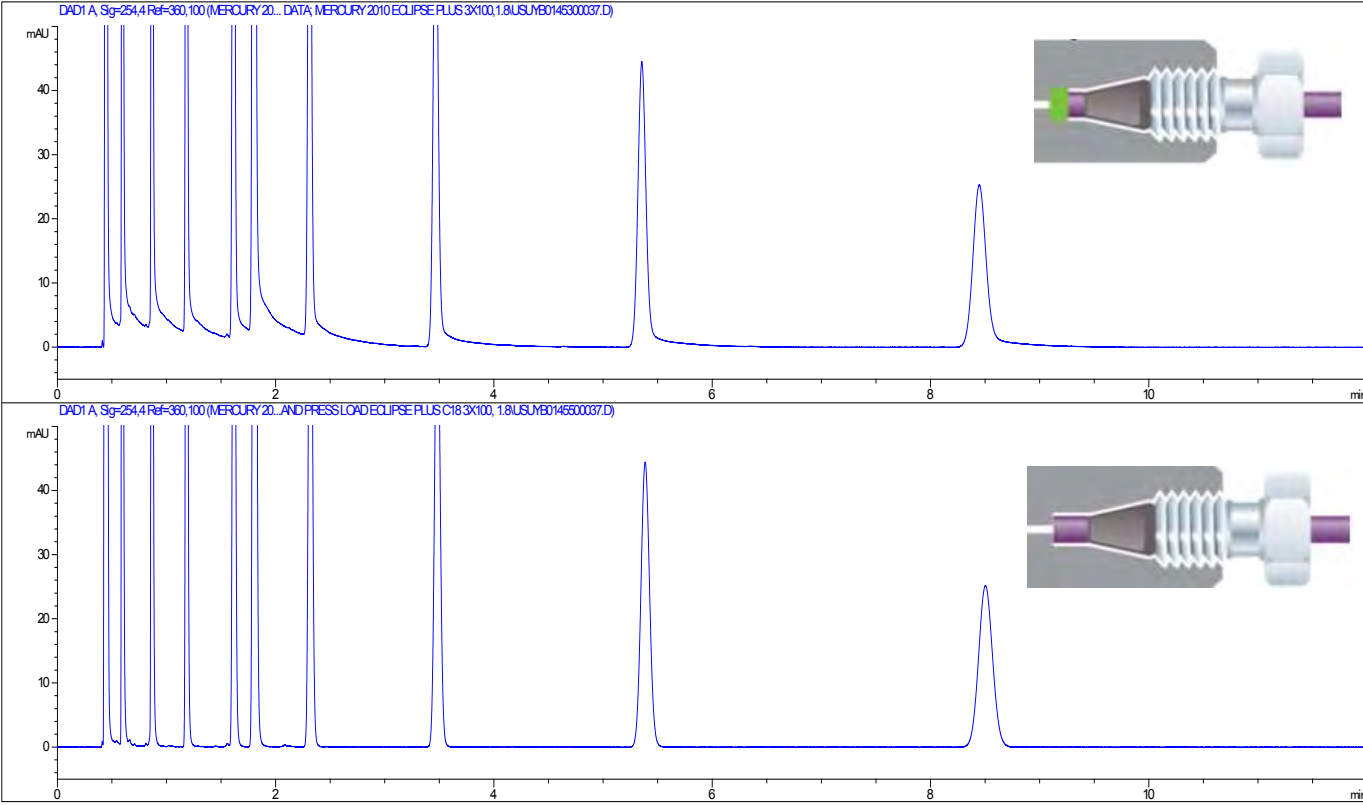

Swaging Fittings



Slide nut over tubing
and then add ferrule.

Swaging Fittings



Swaging Fittings

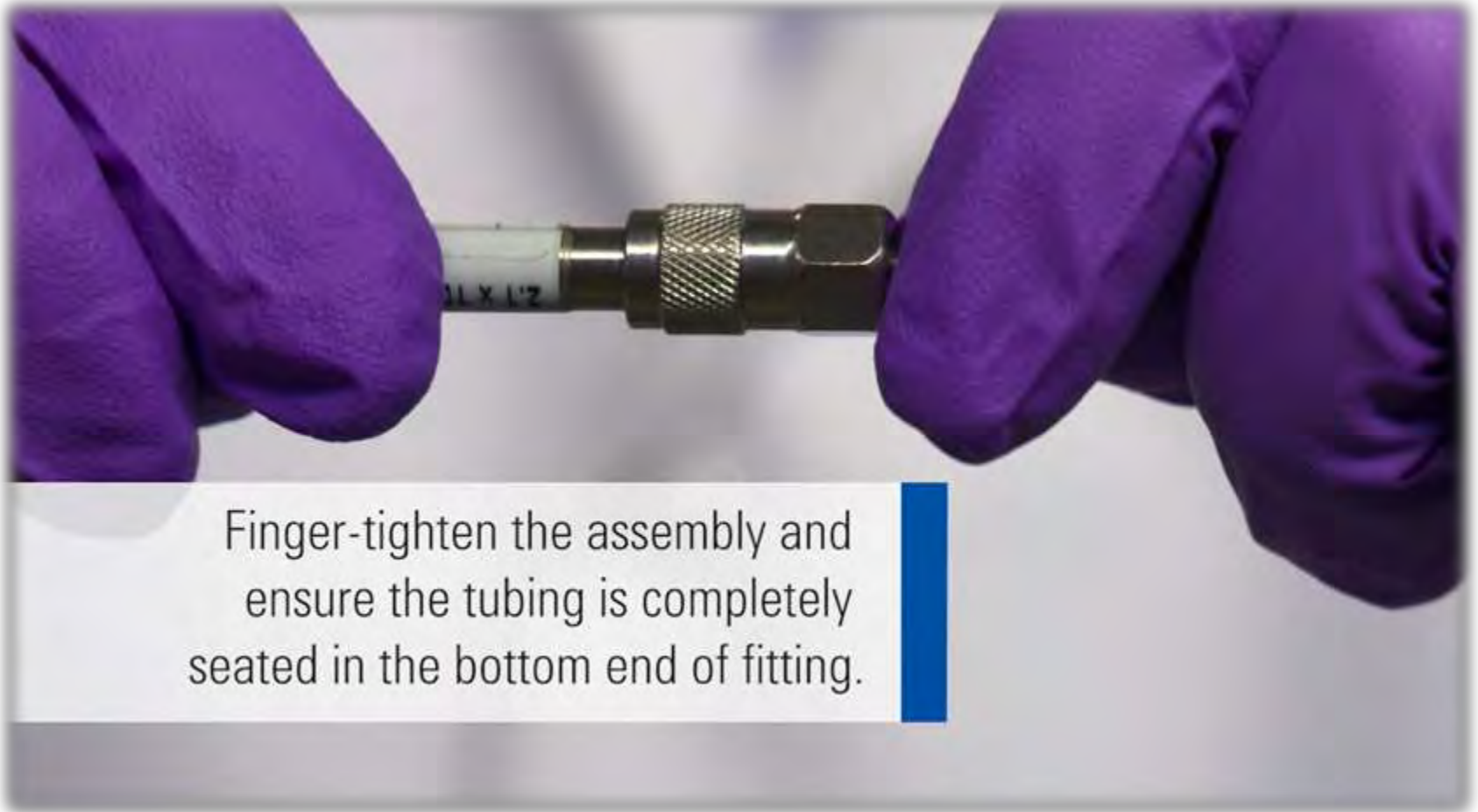

Finger-tighten the assembly and ensure the tubing is completely seated in the bottom end of fitting.

Swaging Fittings

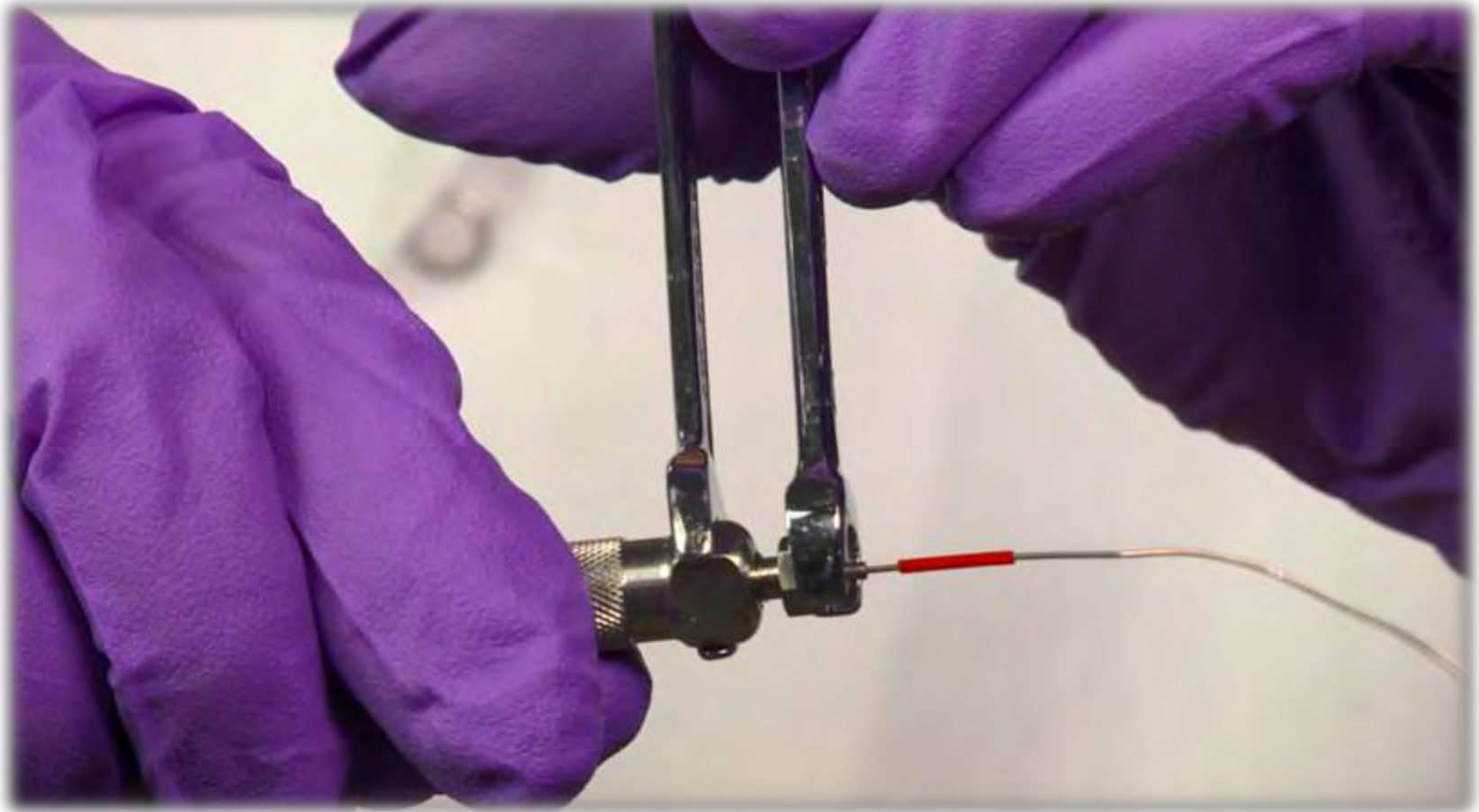

Inspect the Position of the Ferrule

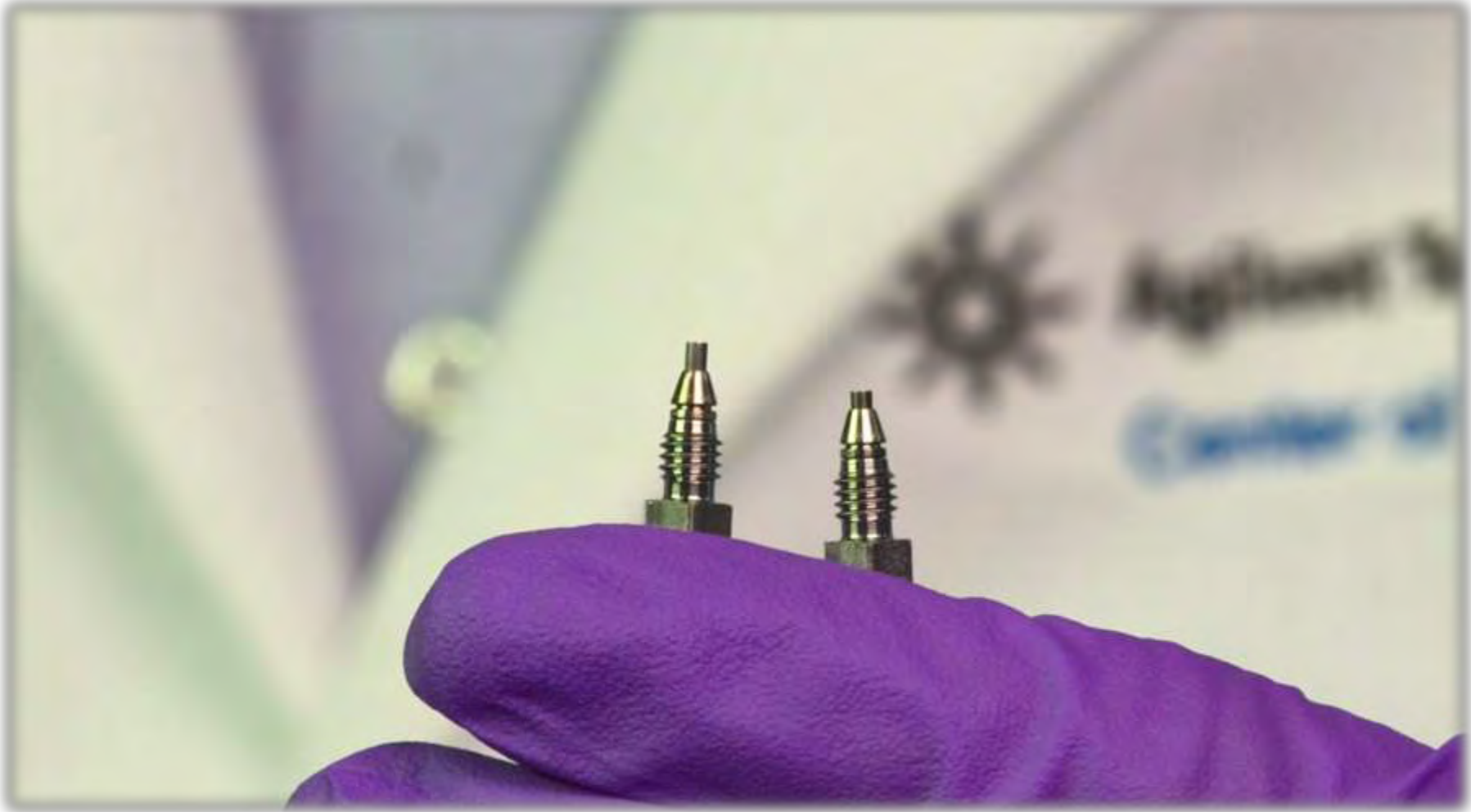

Tools



Tightening Fittings into a Column

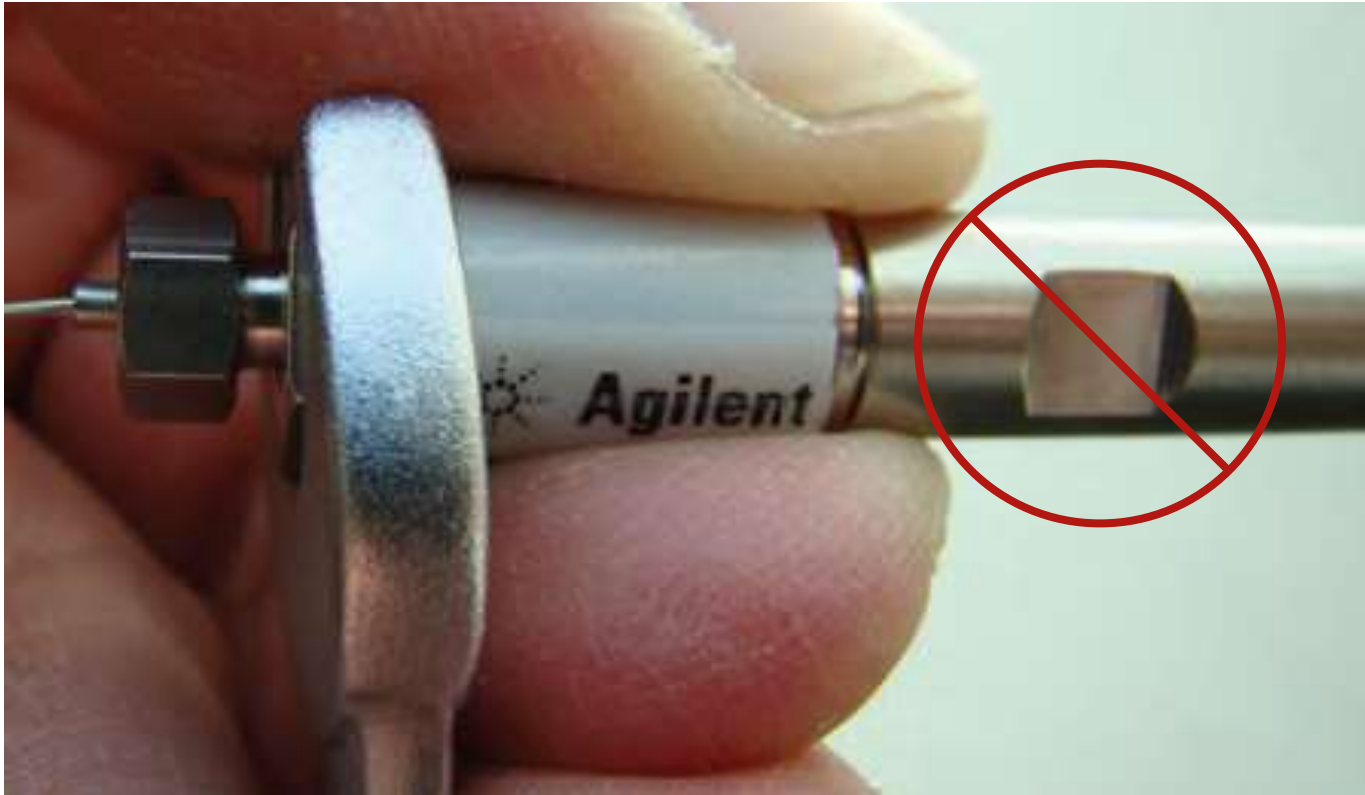

Overtightened Fittings

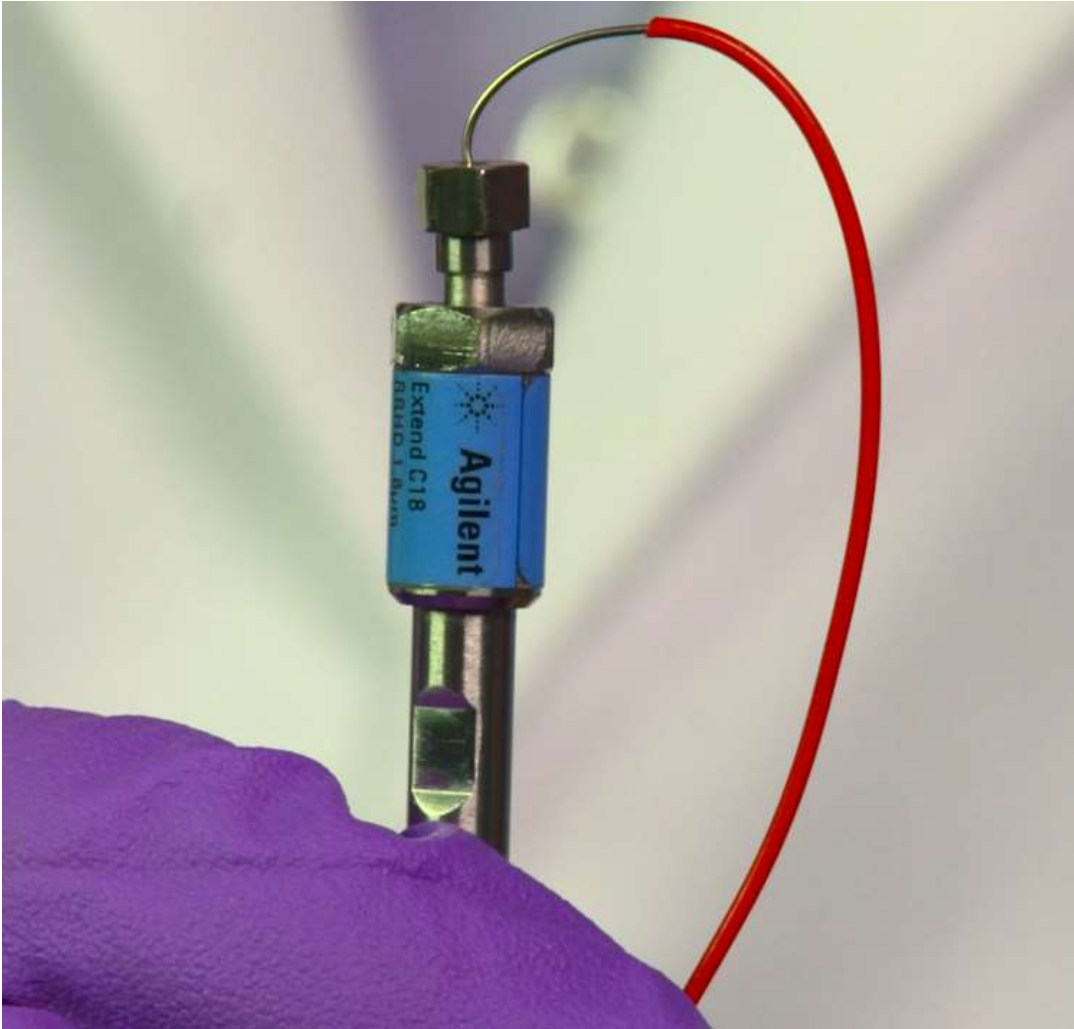

Overtightened Fittings



A-Line Fitting: Unique Spring-loaded Design

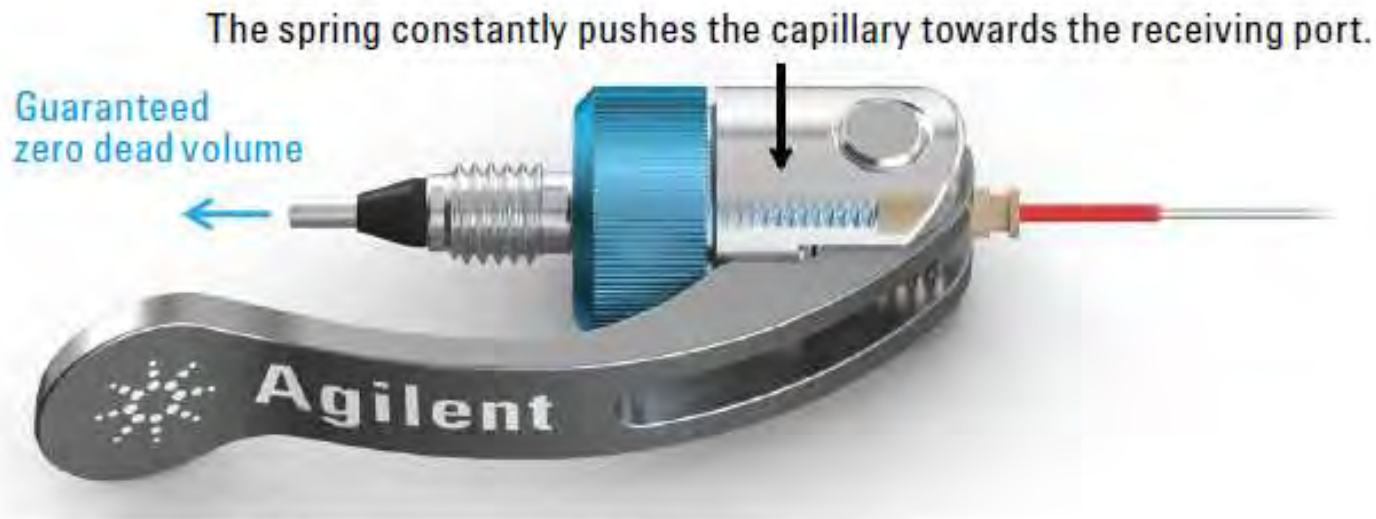

- The unique spring-loaded design applies a constant force to eliminate dead volume
- Fingertight to 1300 bar

A-Line Quick Connect Fitting



Connection problems can lead to:

- *Downtime*
- *High cost of operation*

- Poor chromatography results
 - Broad or tailing peaks
 - Loss of resolution
- Expensive maintenance cost
 - Overtightening
 - Column damage
 - Leaks, added troubleshooting



A-Line Quick Connect Fitting



A-Line Quick Turn Fitting

A-Line Fittings Last

Chromatogram overlap before and after 200 reconnections

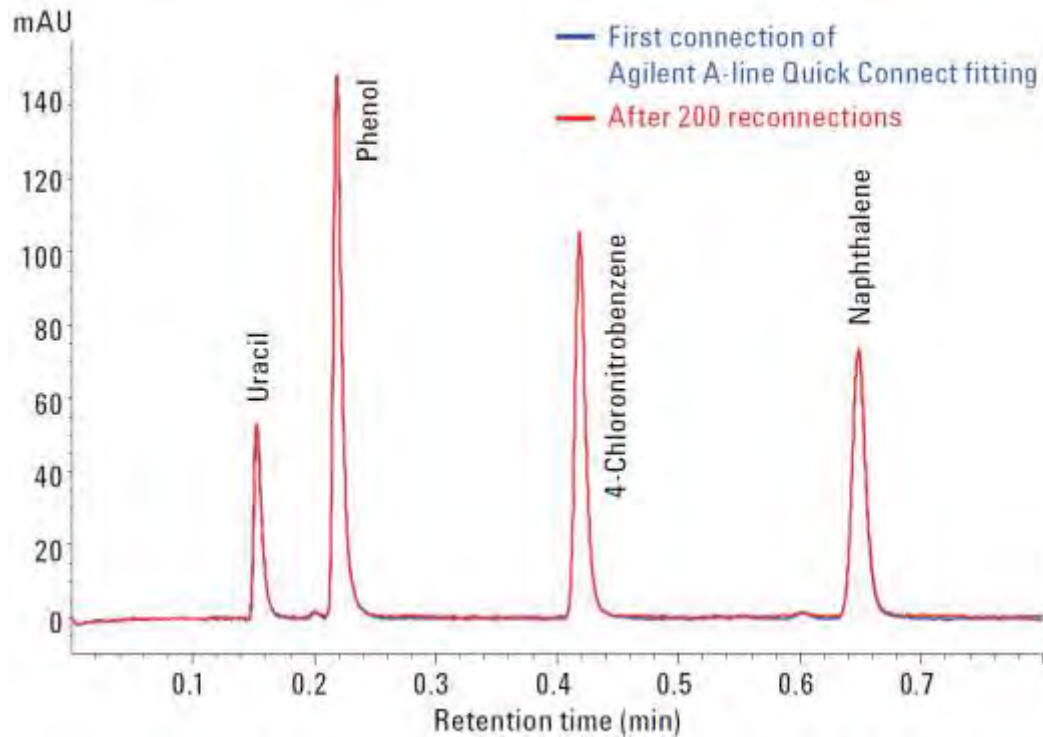

- No visible change of chromatogram after 200 reconnections.

A-Line Fittings Last

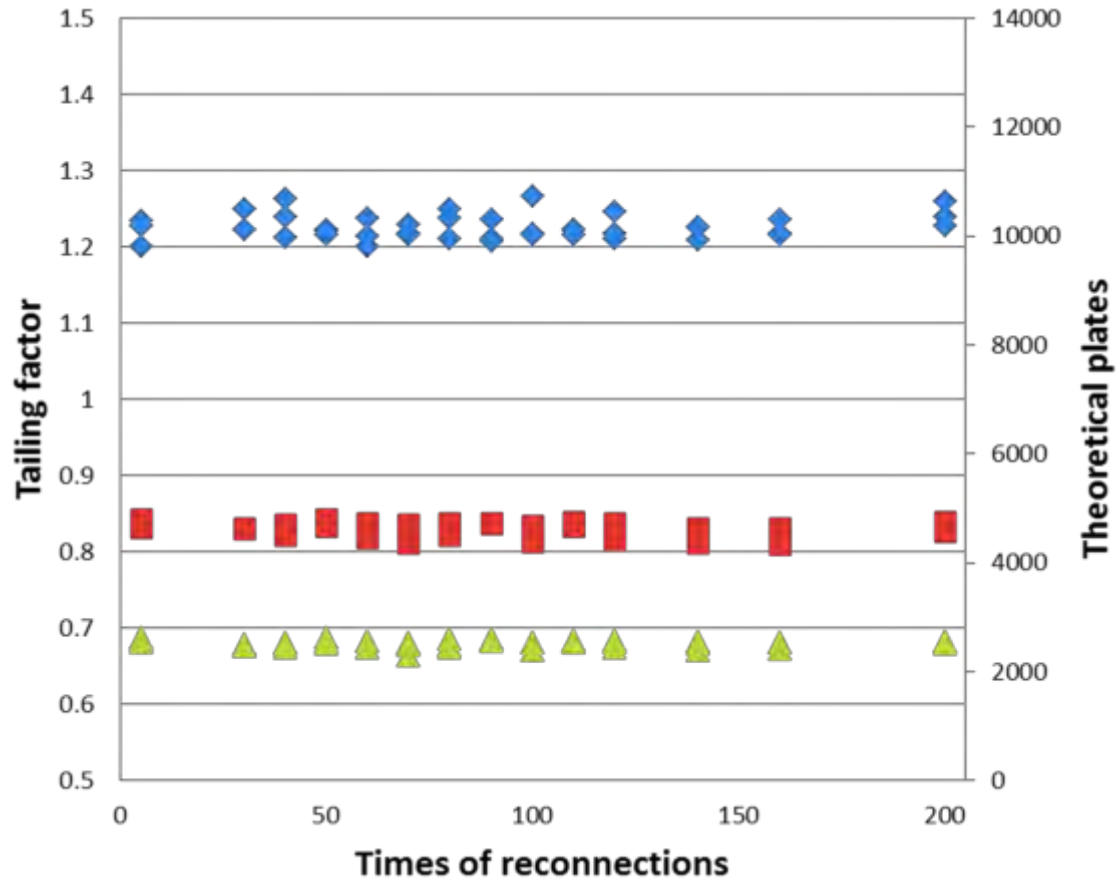

- Tailing factors and theoretical plates stayed constant within the experimental allowance through the reconnection procedures.

UHPLC Fingertight Fitting from Another Vendor

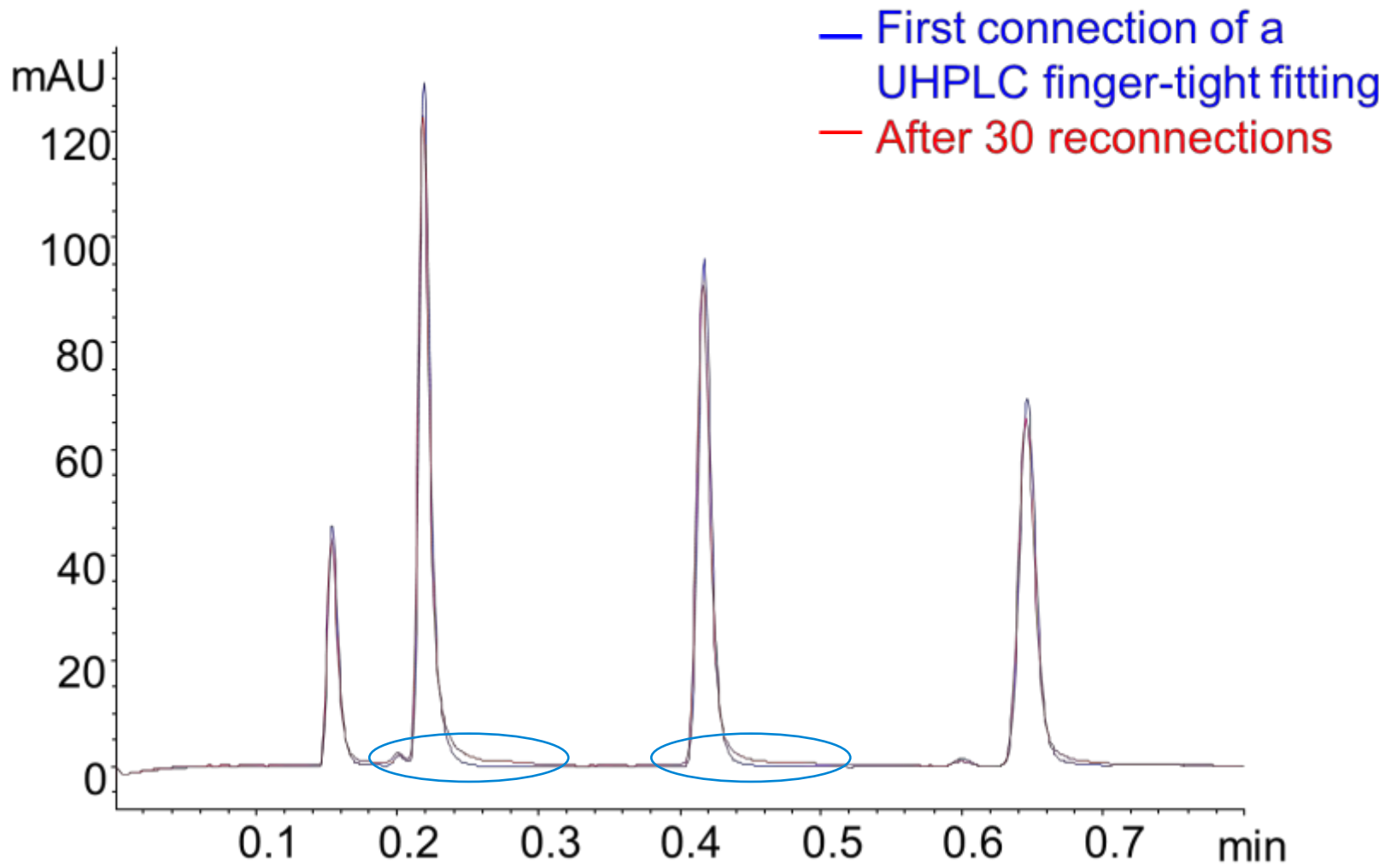

Using the Quick Connect fitting



Finger tighten the fitting until you feel resistance, then close the lever.

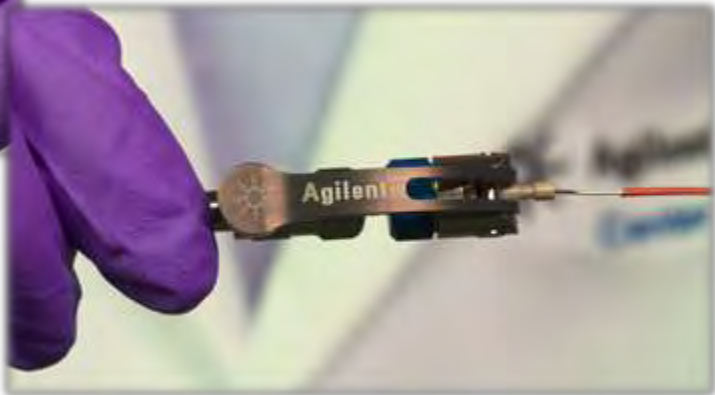
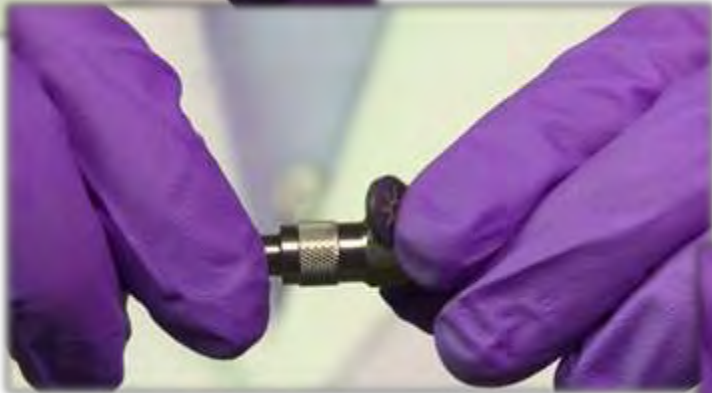

Leak tight to 1300 bar

Using the Quick Turn fitting



Finger tighten for 600 bar

Wrench tighten for 1300 bar

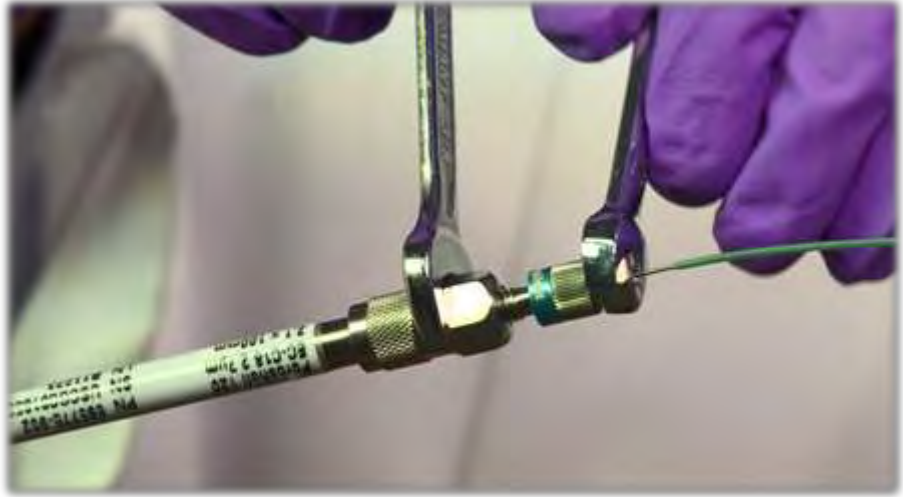

Quick Connect/Turn Fittings Use Specific Capillaries



Quick Connect fitting requires capillary with spring and a PEEK component



Quick Turn fitting needs capillary with long socket due to its internal spring action

A wide variety of capillary lengths and inner diameters are available to meet HPLC and UHPLC needs

Zero Dead Volume Connections

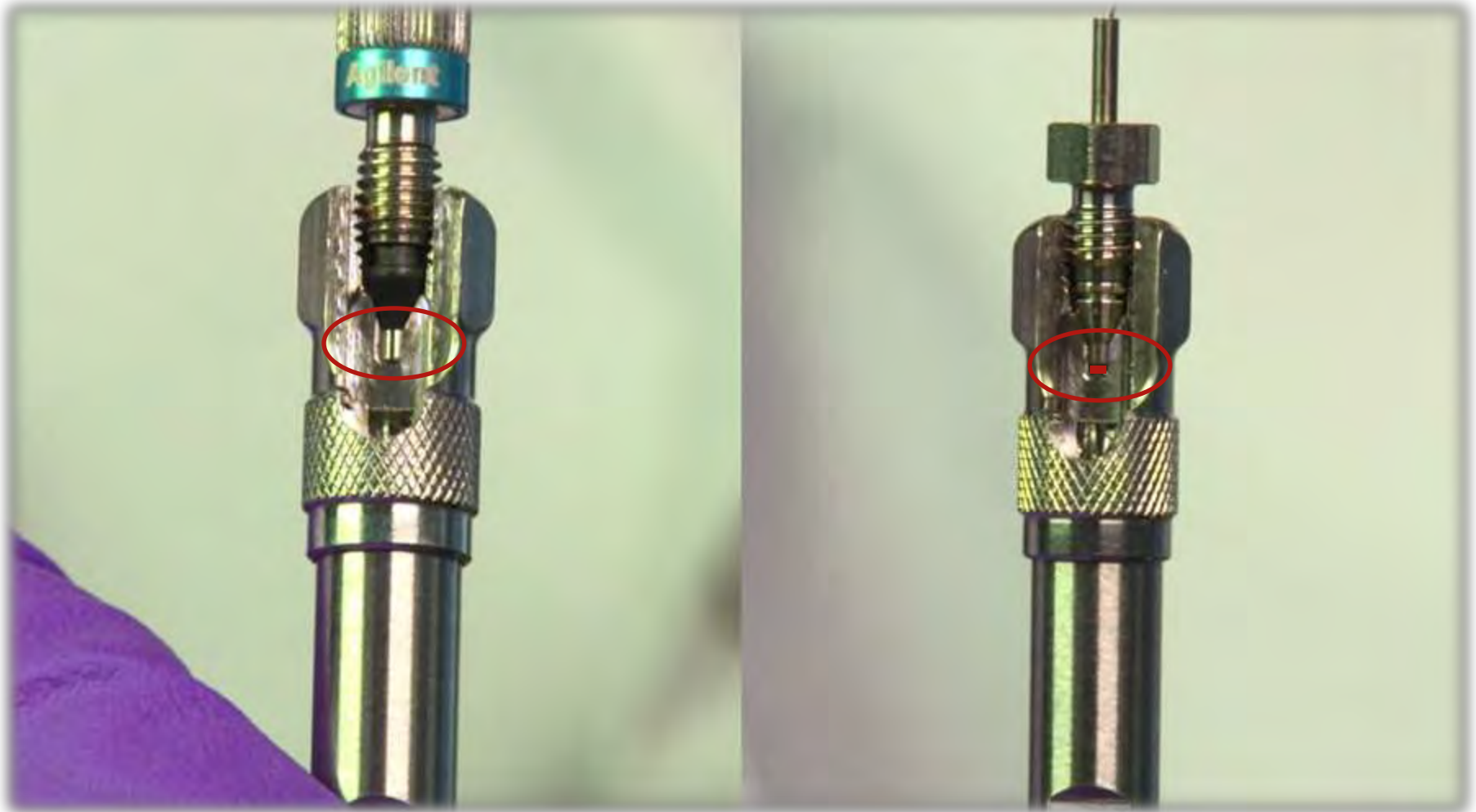

Not Just for Agilent Columns



A-Line Fittings Tips



A ZDV union can be used to adapt to heat exchangers but....



A-Line Fittings in Action

Low Dispersion Heat Exchanger
G1316-80022



Works great with the latest low dispersion heat exchanger for G1315B/C TCC

A-Line Fittings in Action



Replacing Capillaries and Ferrules



If the capillary is damaged, or another dimension is needed, just use a plier to remove the capillary and insert a new one.

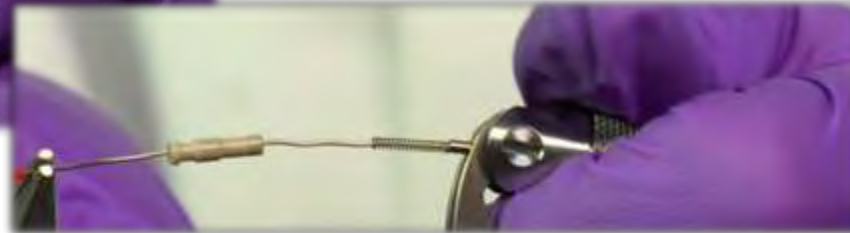

The ferrules can also be replaced; just use pliers to remove the ferrule and insert a new one.

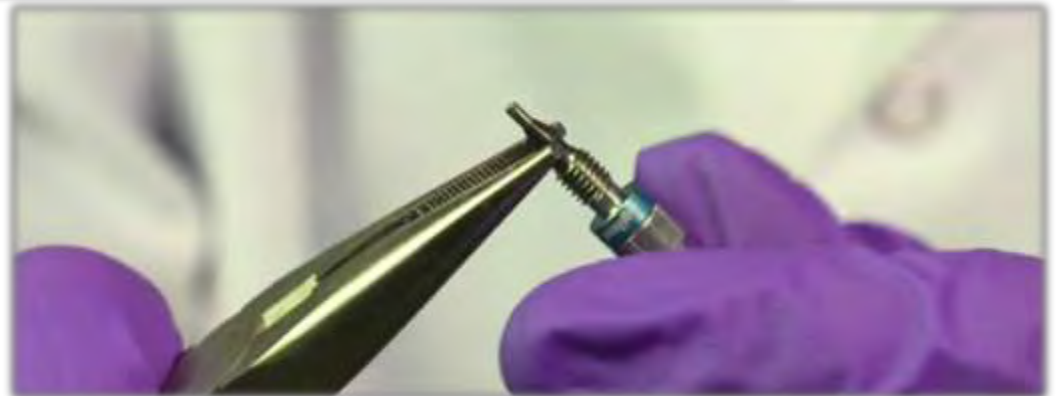

Quick Connect

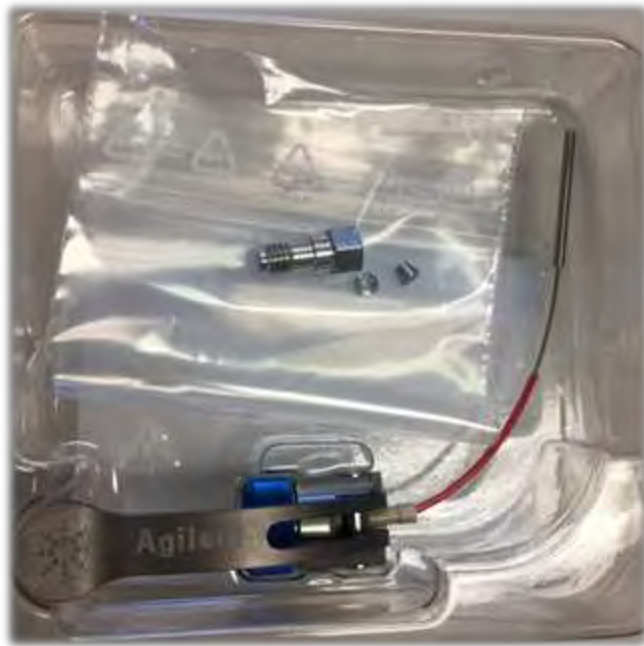

- Quick Connect fittings are sold as an assembly
- Comes with a Swagelok fitting for other end
- Replacement capillaries are also available

A-Line Quick Connect Assemblies	
5067-5957	A-Line Quick Connect Assy ST 0.12x105mm
5067-5958	A-Line Quick Connect Assy ST 0.12x150mm
5067-5959	A-Line Quick Connect Assy ST 0.12x220mm
5067-5960	A-Line Quick Connect Assy ST 0.12x280mm
5067-5961	A-Line Quick Connect Assy ST 0.075x105mm
5067-6163	A-Line Quick Connect Assy ST 0.075x150mm
5067-6164	A-Line Quick Connect Assy ST 0.075x220mm
5067-6165	A-Line Quick Connect Assy ST 0.075x280mm
5067-6166	A-Line Quick Connect Assy ST 0.17x105mm
5067-6167	A-Line Quick Connect Assy ST 0.17x150mm
5067-6168	A-Line Quick Connect Assy ST 0.17x220mm
5067-6169	A-Line Quick Connect Assy ST 0.17x280mm
5067-6602	A-Line QC/QT Assembly 0.075x105mm
5067-6210	A-Line quick connect assy ST 0.25x105mm with a female connection
5067-6195	A-Line Quick Connect Assy ST 0.12x120
5067-6196	A-Line Quick Connect Assy ST 0.17x120

Note: Each assembly is equipped with a Quick Connect fitting, a capillary and a Swagelok fitting or with a female connection where specified

Capillaries for Quick Connect fitting	
5500-1170	A-Line Capillary ST 0.12mmx280mm
5500-1171	A-Line Capillary ST 0.12mmx220mm
5500-1172	A-Line Capillary ST 0.12mmx150mm
5500-1173	A-Line Capillary ST 0.12mmx105mm
5500-1174	A-Line Capillary ST 0.075mmx105mm
5500-1175	A-Line Capillary ST 0.075mm x 150mm
5500-1176	A-Line Capillary ST 0.075mm x 220mm
5500-1177	A-Line Capillary ST 0.075mm x 250mm
5500-1178	A-Line Capillary ST 0.075mm x 280mm
5500-1179	A-Line Capillary ST 0.12mm x 400mm
5500-1180	A-Line Capillary ST 0.12mm x 500mm
5500-1181	A-Line Capillary ST 0.17mm x 105mm
5500-1182	A-Line Capillary ST 0.17mm x 150mm
5500-1183	A-Line Capillary ST 0.17mm x 220mm
5500-1230	A-Line Capillary ST 0.17mm x 280mm
5500-1231	A-Line Capillary ST 0.17mm x 500mm
5500-1247	A-Line Capillary ST 0.12x120
5500-1248	A-Line Capillary ST 0.17x120
5500-1258	A-Line capillary ST 0.25mm x 105mm with a female connection
5500-1259	A-Line capillary ST 0.25mm x 150mm
5500-1260	A-Line capillary ST 0.25mm x 400mm
5500-1289	A-Line Capillary ST 0.12x150 M4
5500-1291	A-Line Capillary ST 0.17x150 M4

Fittings	
5067-5965	A-Line Quick Connect LC fitting
5043-0924	A-Line front ferrule

Quick Turn

Capillaries for Quick Turn fitting	
5500-1188	Capillary ST 0.12mm x 105mm long socket
5500-1189	Capillary ST 0.12mm x 150mm long socket
5500-1190	Capillary ST 0.12mm x 200mm long socket
5500-1191	Capillary ST 0.12mm x 280mm long socket
5500-1192	Capillary ST 0.12mm x 500mm long socket
5500-1193	Capillary ST 0.17mm x 105mm long socket
5500-1194	Capillary ST 0.17mm x 150mm long socket
5500-1195	Capillary ST 0.17mm x 200mm long socket
5500-1196	Capillary ST 0.17mm x 280mm long socket
5500-1197	Capillary ST 0.17mm x 500mm long socket
5500-1198	Capillary ST 0.075mm x 105mm long socket
5500-1200	Capillary ST 0.12mm x 130mm long socket M4
5500-1205	Capillary ST 0.075mm x 500mm long socket
5500-1206	Capillary ST 0.075mm x 250mm long socket
5500-1232	Capillary ST 0.075mm x 150mm Long Socket
5500-1233	Capillary ST 0.12mm x 180mm Long Socket
5500-1234	Capillary ST 0.17mm x 180mm Long Socket
5500-1235	Capillary ST 0.17mm x 380mm Long Socket
5500-1236	Capillary ST 0.17mm x 400mm Long Socket
5500-1237	Capillary ST 0.17mm x 700mm Long Socket
5500-1243	Capillary SST 0.12x50mm long Socket
5500-1249	Capillary ST 0,12x120 SL/SL Long Socket
5500-1250	Capillary ST 0,17x120 SL/SL Long Socket
5500-1251	Capillary ST 0,12x400 SL/SL Long Socket
5500-1252	Capillary ST 0,17x400 SL/SL Long Socket
5500-1261	Capillary ST 0.25mm x 105mm long socket with a female connection
5500-1262	Capillary ST 0.25mm x 150mm long socket
5500-1263	Capillary ST 0.25mm x 400mm long socket
5500-1288	Capillary ST 0.12x150 long socket M4
5500-1290	Capillary ST 0.17x150 long socket M4
Fittings	
5067-5966	A-Line Quick Turn LC Fitting
5043-0924	A-Line front ferrule



Quick Turn capillaries and fittings are sold separately

A-Line Fittings

Agilent A-Line Quick Connect fittings

Getting a perfect column connection, every time, by any operator.



A-Line Quick Turn Fitting



A-Line Quick Connect Fitting

Easy to use	No tools - Truly finger tight up to 1300 bar.
	Use a Quick Connect fitting for the column inlet and a Quick Turn fitting for the column outlet
	Compatible systems: Agilent portfolio - 1290, 1260, 1200, 1100 and the Waters Alliance systems
	Works on Agilent, Waters, Phenomenex and Supelco Columns – Great results!
	Fast column connection – make multiple column switches in seconds
Time and Cost Savings	Reliable and reusable multiple times – Capillary and Ferrule are user changeable
	Eliminate leaks and avoid costly column damage
	Reduce time spent troubleshooting. Avoid costly downtime resulting from bad connections
Better Chromatography	Zero dead volume connections
	Application Flexible - capillary length and the internal diameter is application dependent
	All typical lengths and internal diameters available for most connections

Who can use the Quick Connect Fitting?

- Any lab with a range of users, including newer chromatographers who may not have the experience to do traditional fittings well
- Any lab that is changing columns often
- Labs who are seeing variation in chromatographic results – broad or tailing peaks, and are spending time troubleshooting issues
- Any lab looking to make chromatography easier for everyone.... The lever locks the connection, so no tools are needed