

Orbitální pasti v klinické analýze

Lukáš Plaček

 The world leader in serving science

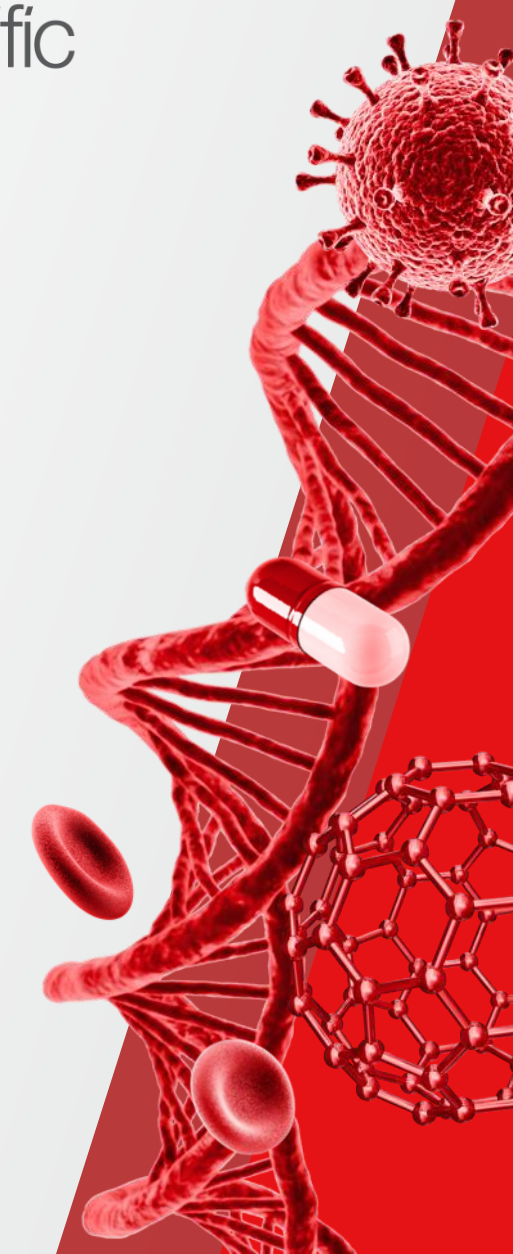

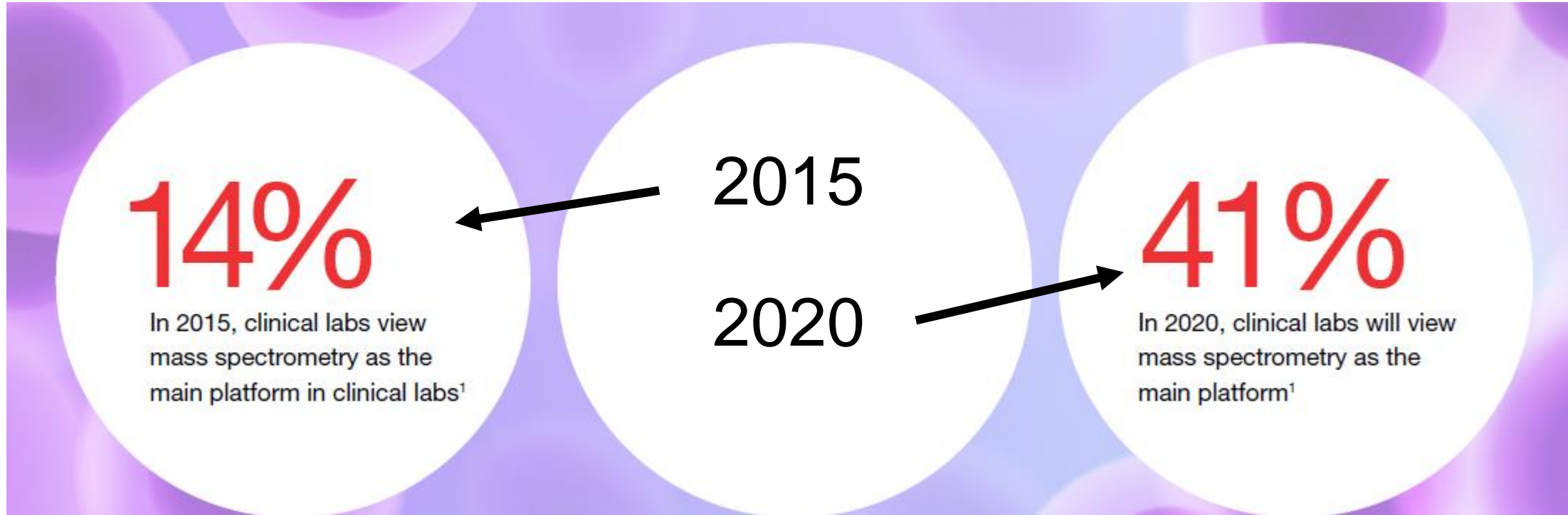

American Association for Clinical Chemistry (AACC)

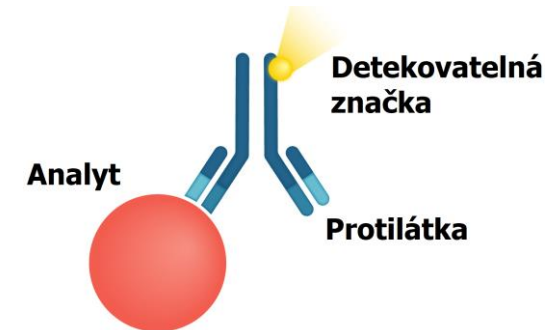

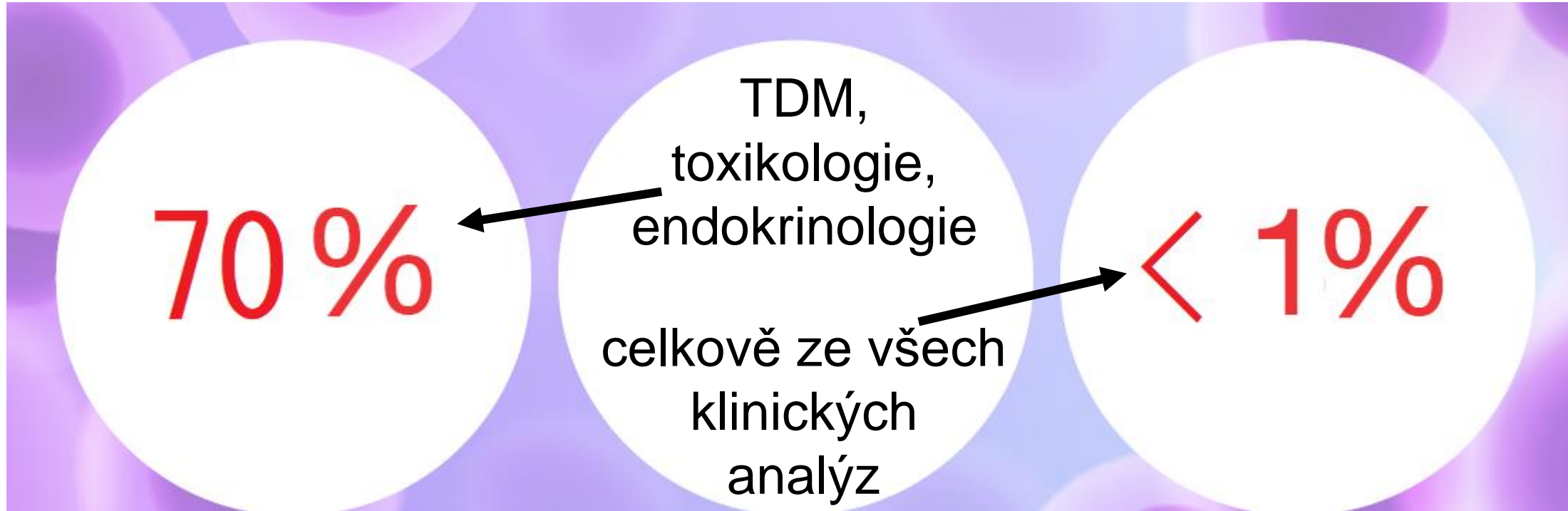

? Zkušený analytik
? Instrumentální úroveň

Clin Biochem Rev. 2011, 32(1), 5–31

Clin. Biochem. 2020, 82, 2-11

Ethyl glukuronid/sulfát

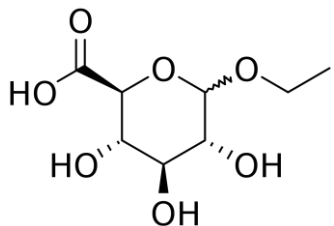
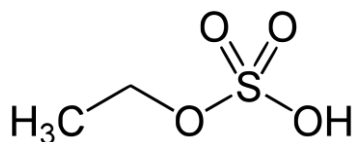

Polarity	Precursor (m/z)	Product (m/z)
Negative	125.062	79.817

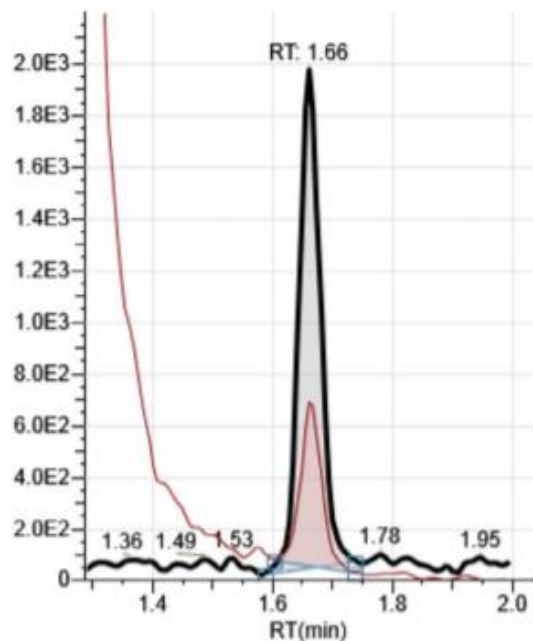
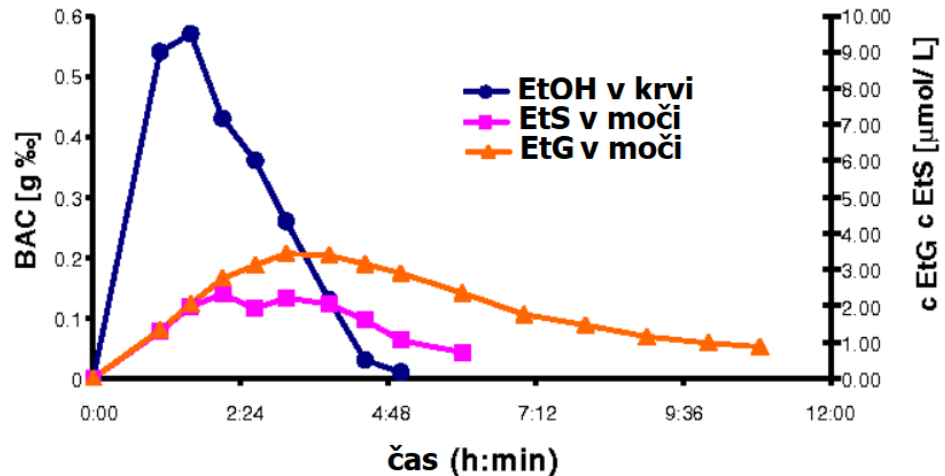

PrimeScreen





Protein MW=7649
(70 AA)

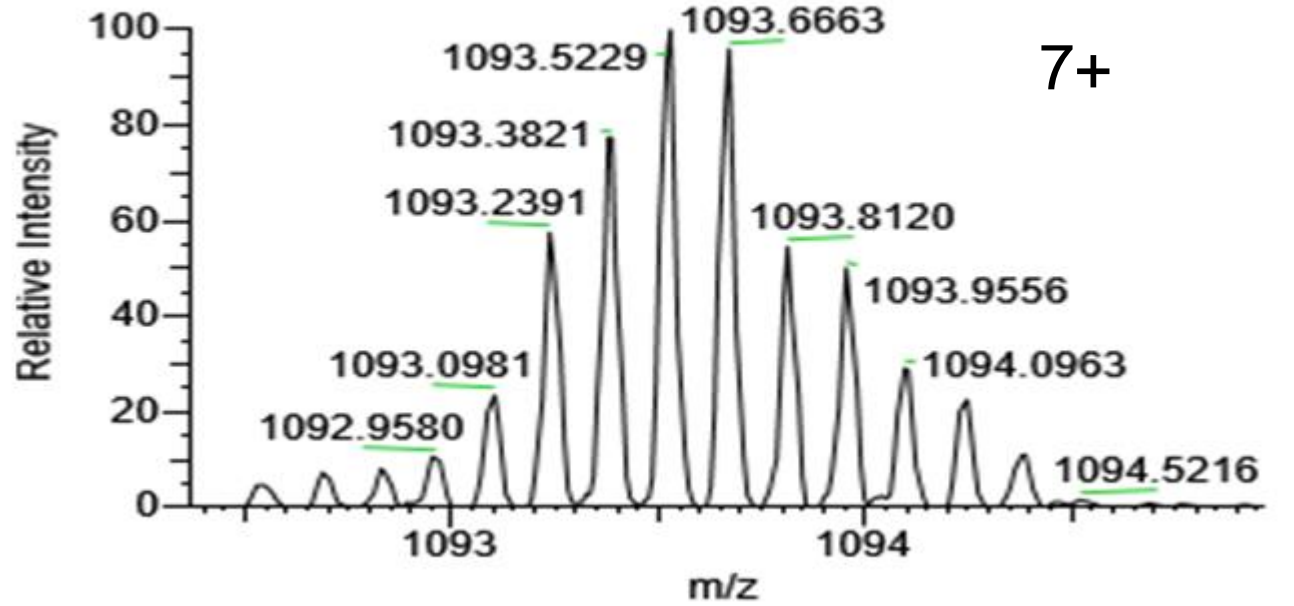

7+

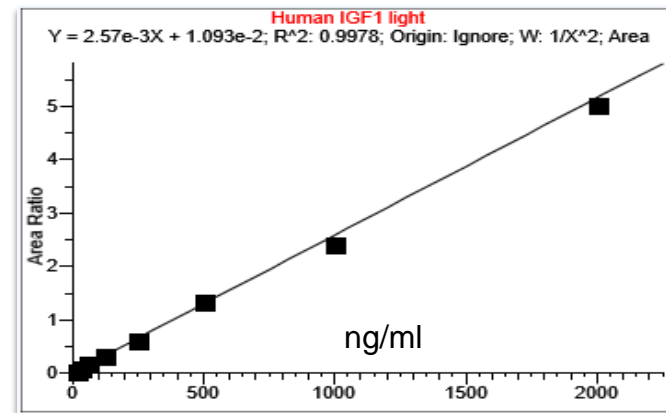

poster Thermo Fisher Scientific, PO65783



Amyloid beta

Normal

Alzheimer's

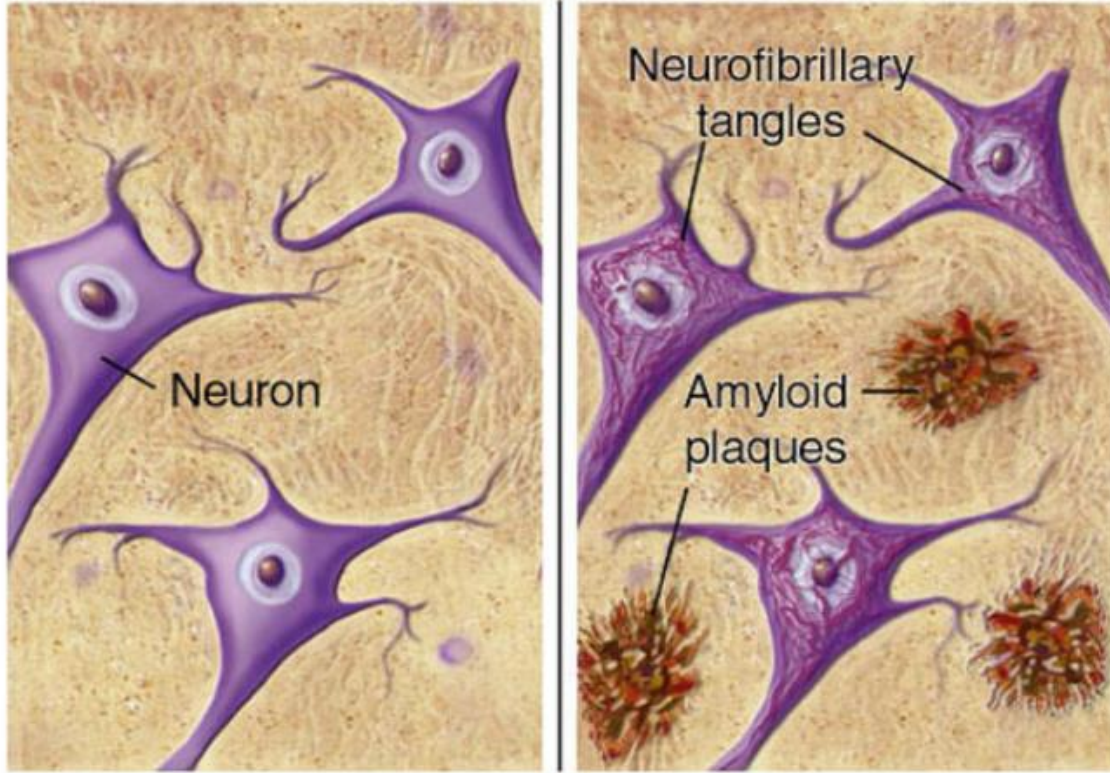

Protein MW=4513
(42 AA)

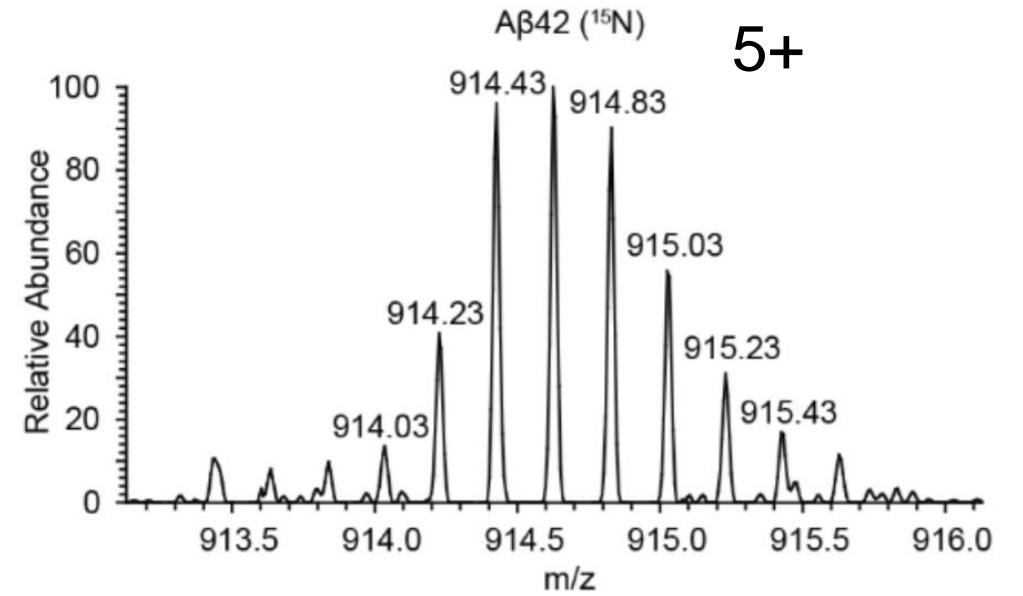
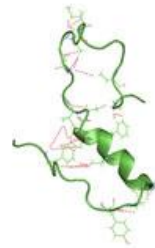

J. Proteome Res. 2021, 20, 8, 4106–4112



immunoassay



hmotnostní spektrometrie



LC-MS Medical Devices (MD) pro In Vitro Diagnostiku (IVD)



Thermo Scientific™ Cascadion™ SM Clinical Analyzer



-omics

METABOLOMIKA
PROTEOMIKA
LIPIDOMIKA

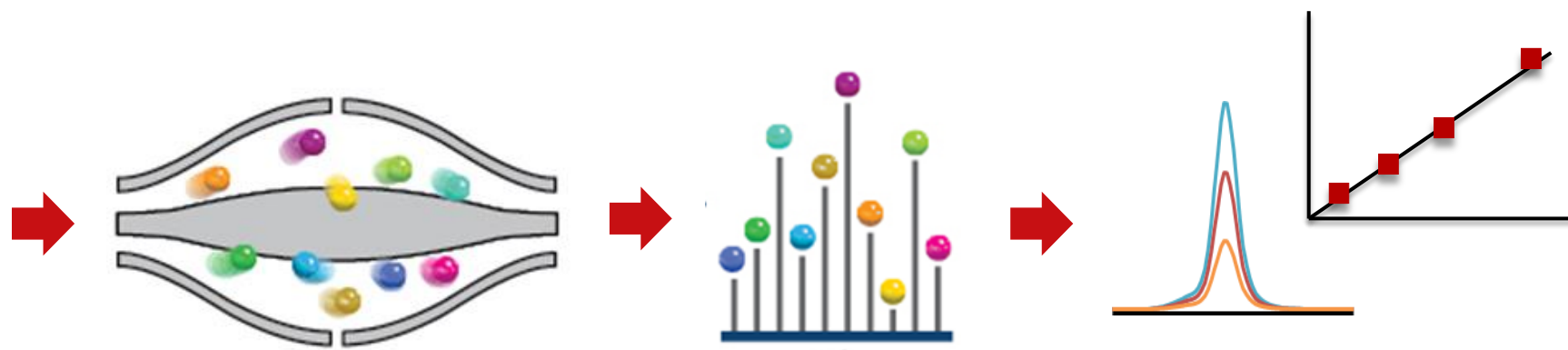

počet analytů

počet vzorků



-omics

METABOLOMIKA
PROTEOMIKA
LIPIDOMIKA

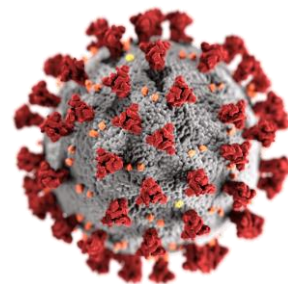
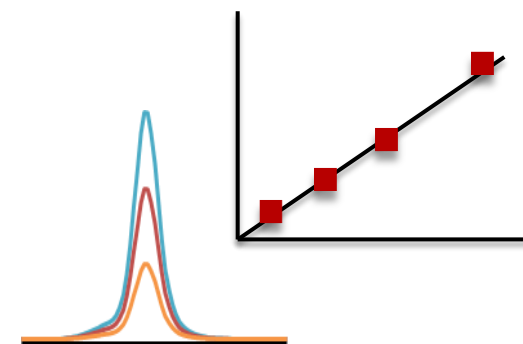
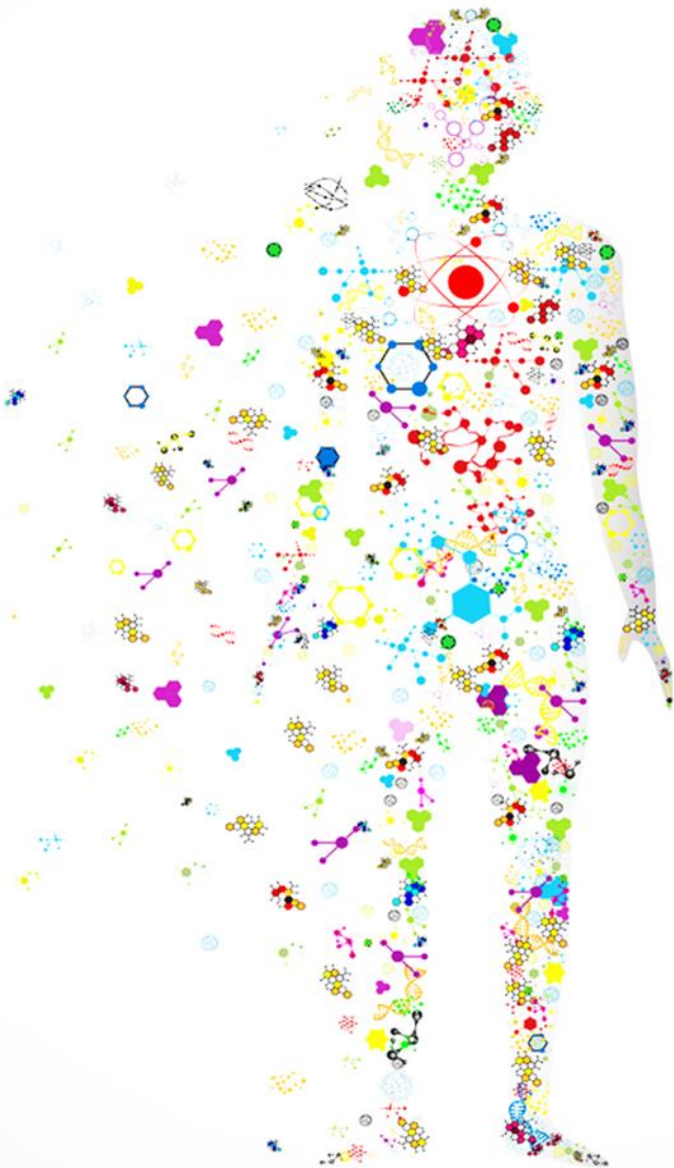

AYNVTQAFGR, MW=1125

		RT-PCR	
n = 88		positive	negative
LC-MS	positive	40	0
LC-MS	negative	8	40

EBioMedicine 2021, 69, 103465
<https://doi.org/10.1101/2021.06.02.21258097>



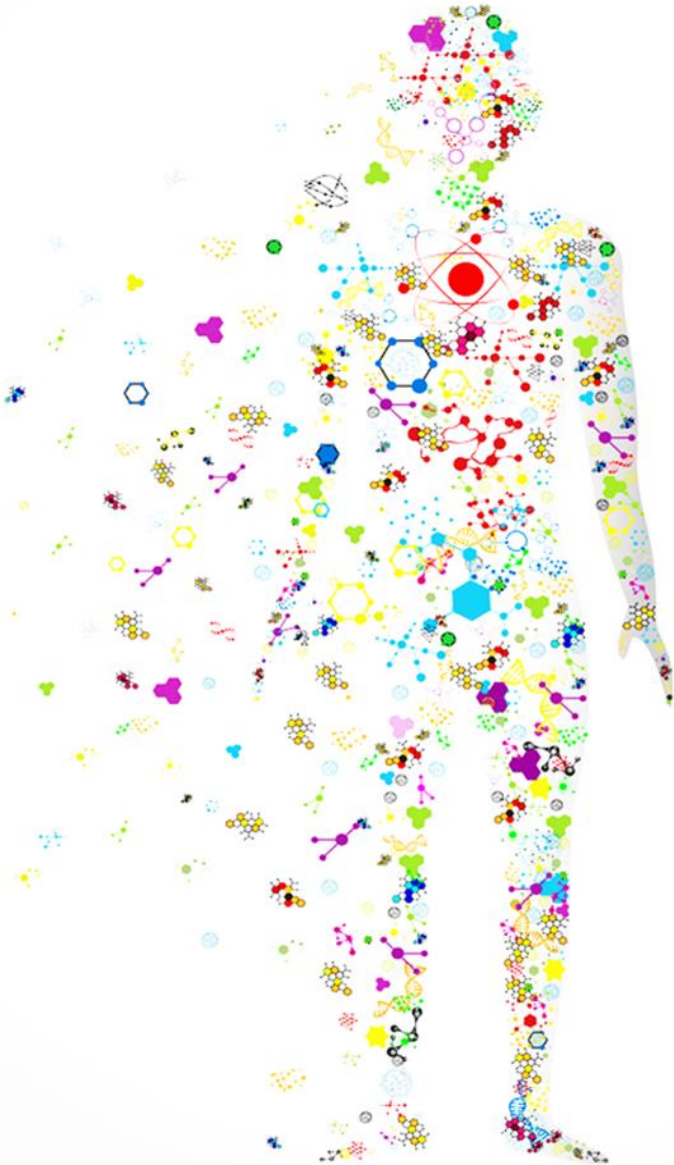

- vysoké rozlišení

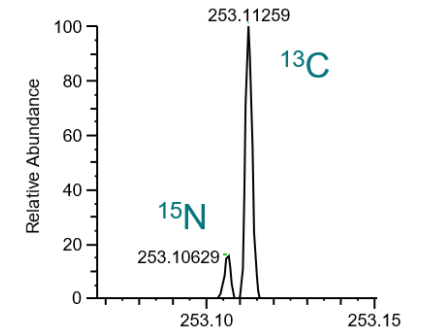

- dlouhodobá stabilita m/z

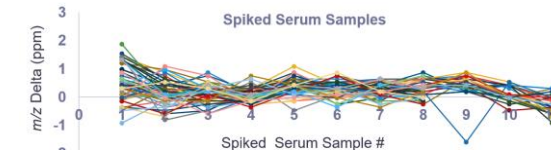

- rychlé přepínání polarit

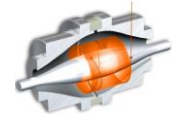

- kombinace akvizičních módů

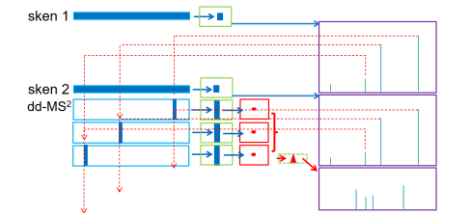



Q-Orbitrap (Explorisy)

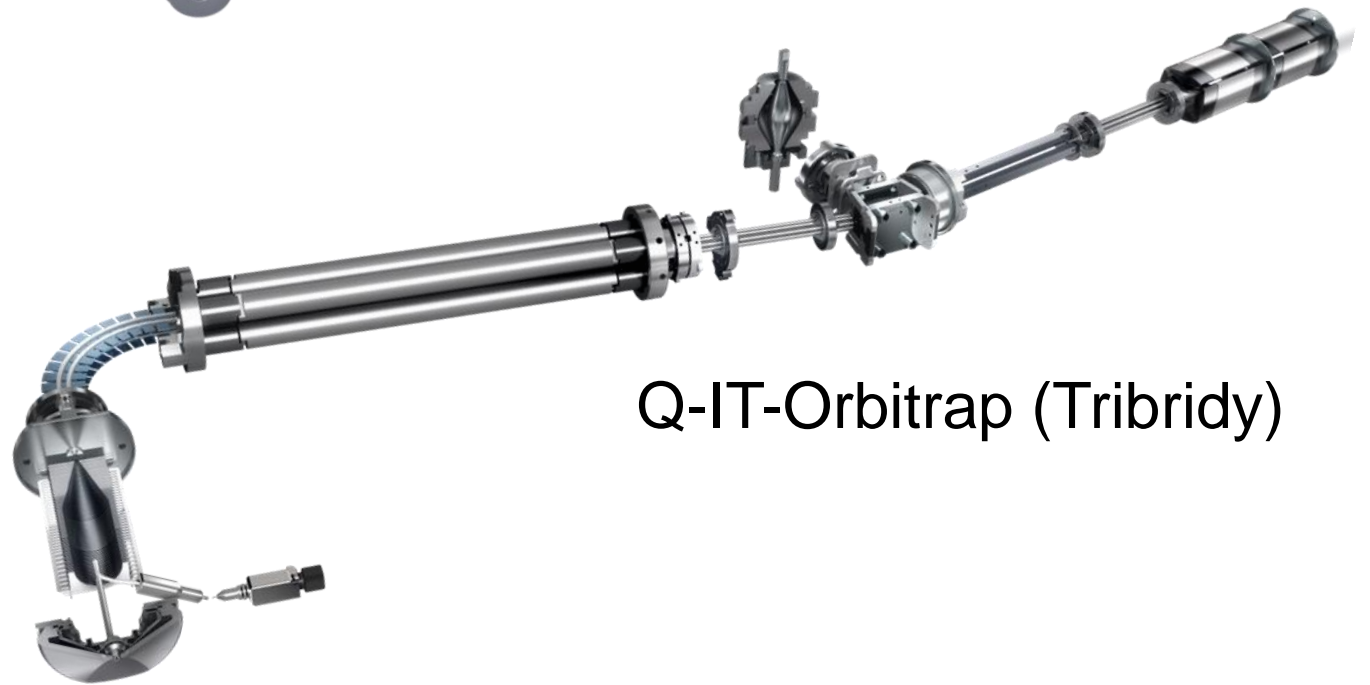

Q-IT-Orbitrap (Tribridy)



Genealogie

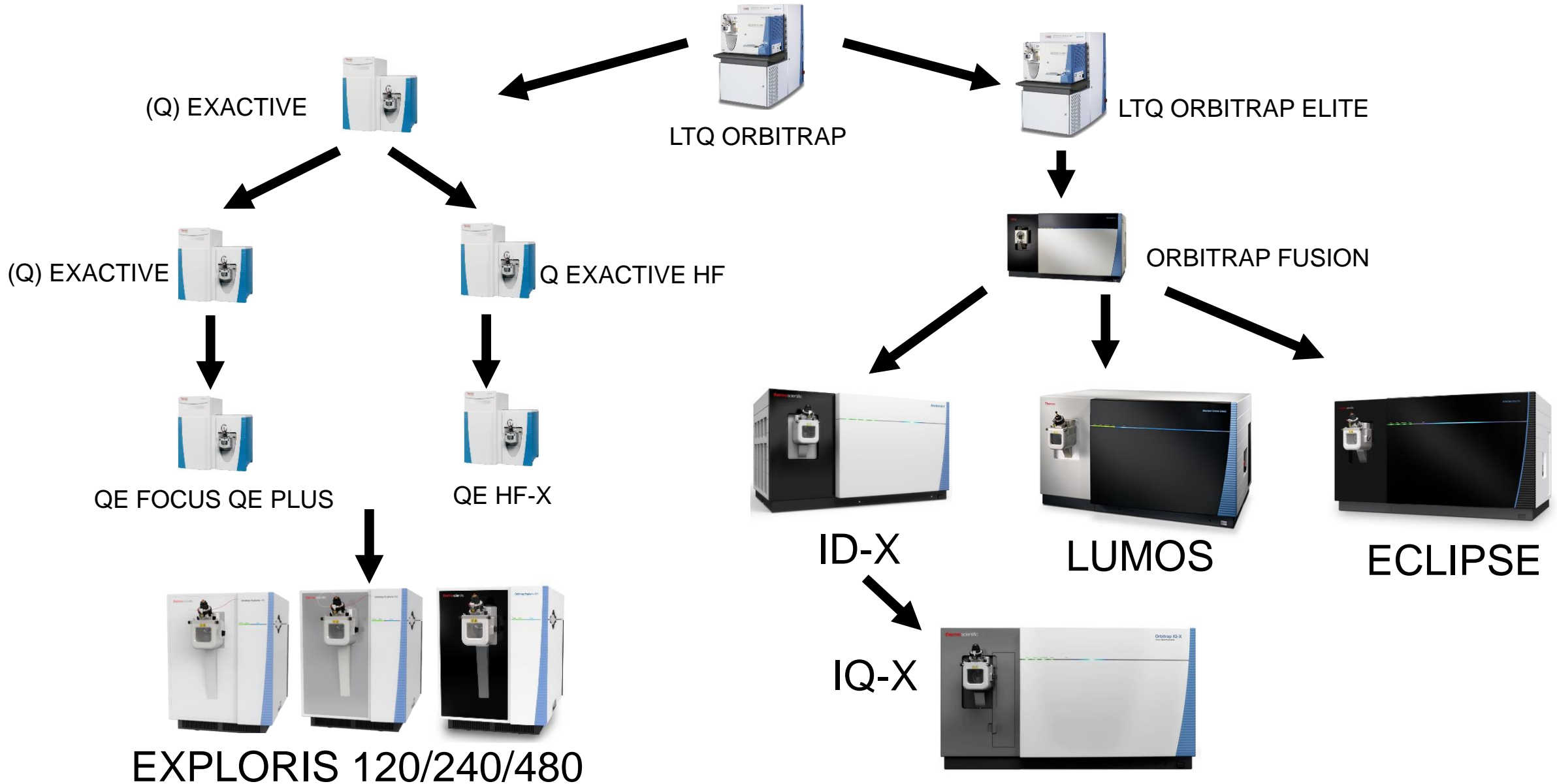

Důležité „periferie“

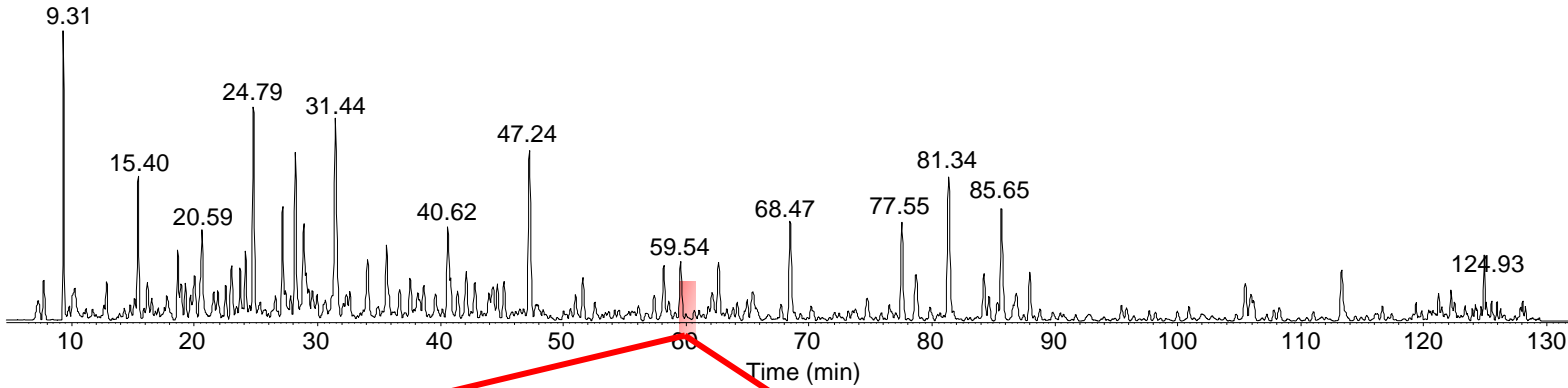

1. Příprava vzorku

2. Separační technika

3. Akvizice a zpracování

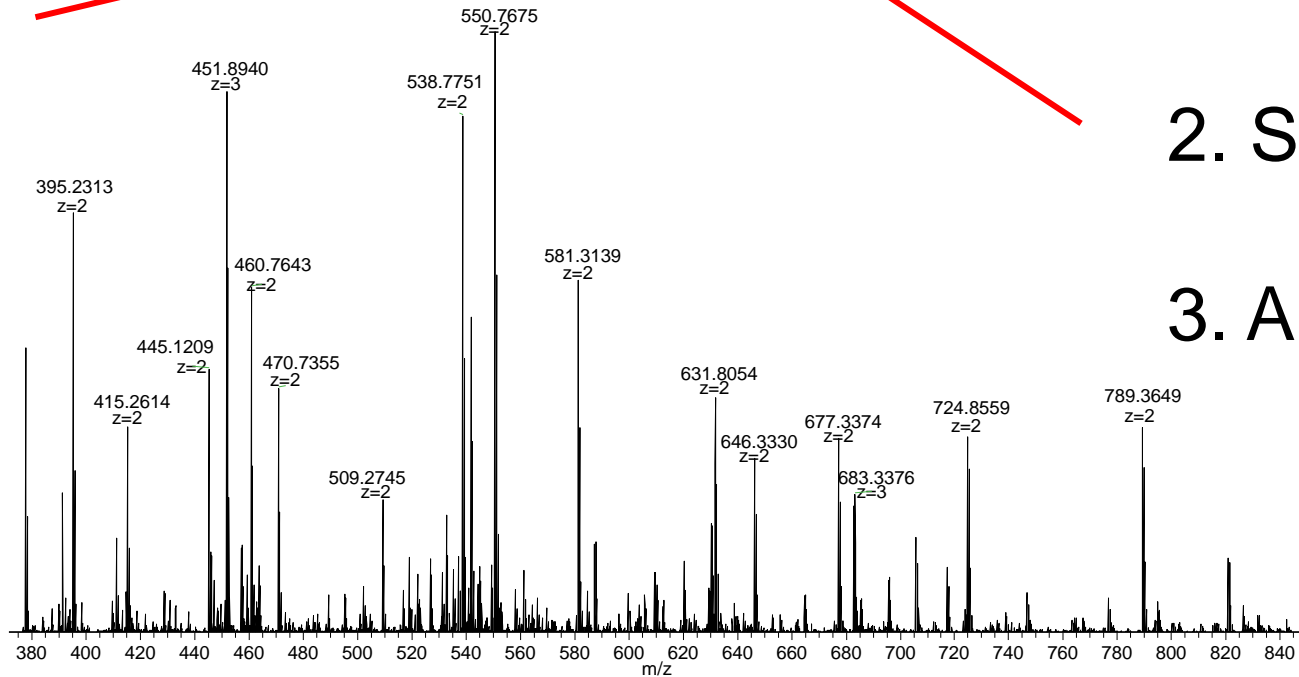
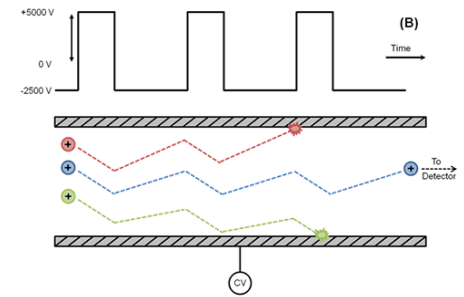

1. Příprava vzorku; paper spray

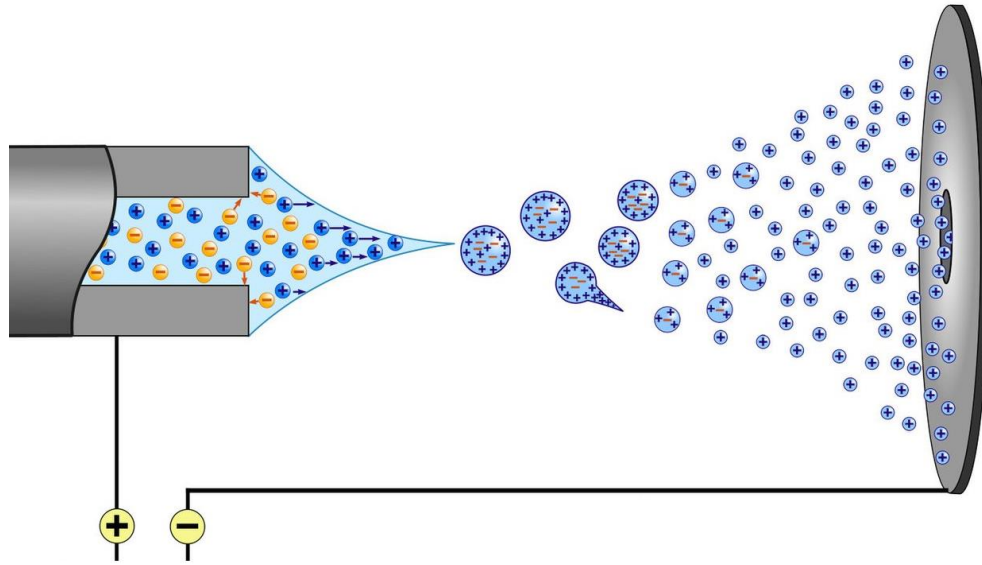

ElectroSpray

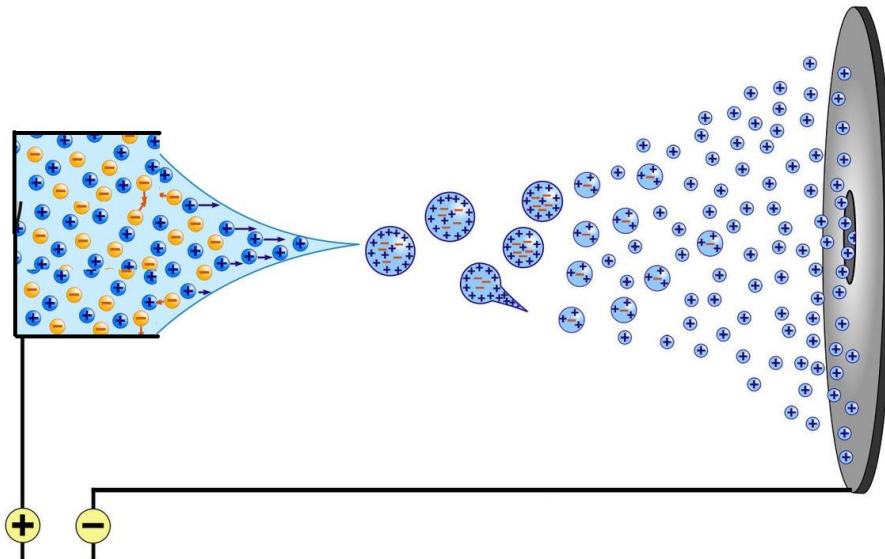

PaperSpray

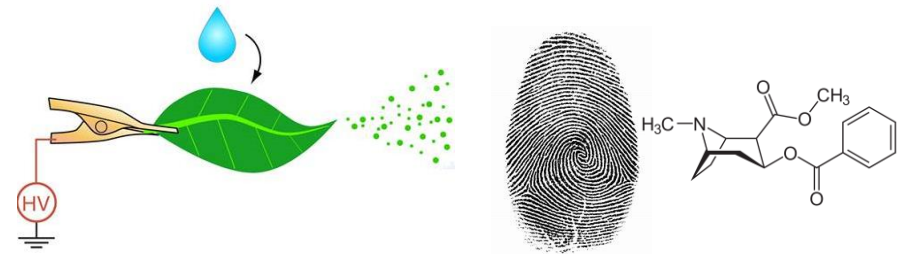

1. Příprava vzorku; paper spray

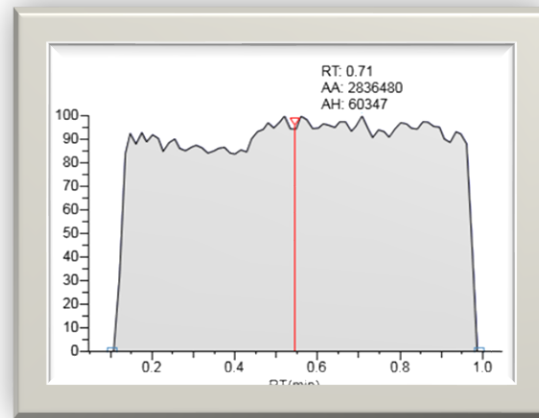
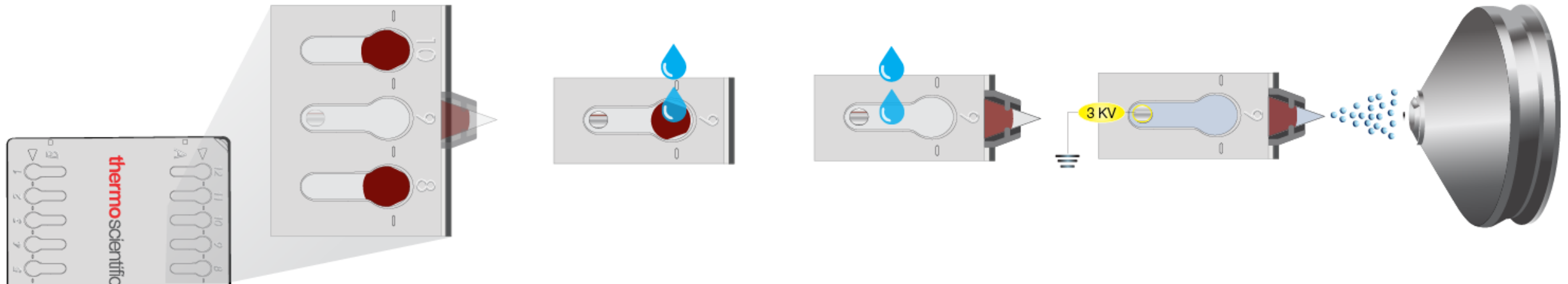

VeriSpray



2. Separáčn technika; HPLC vs. nanoHPLC

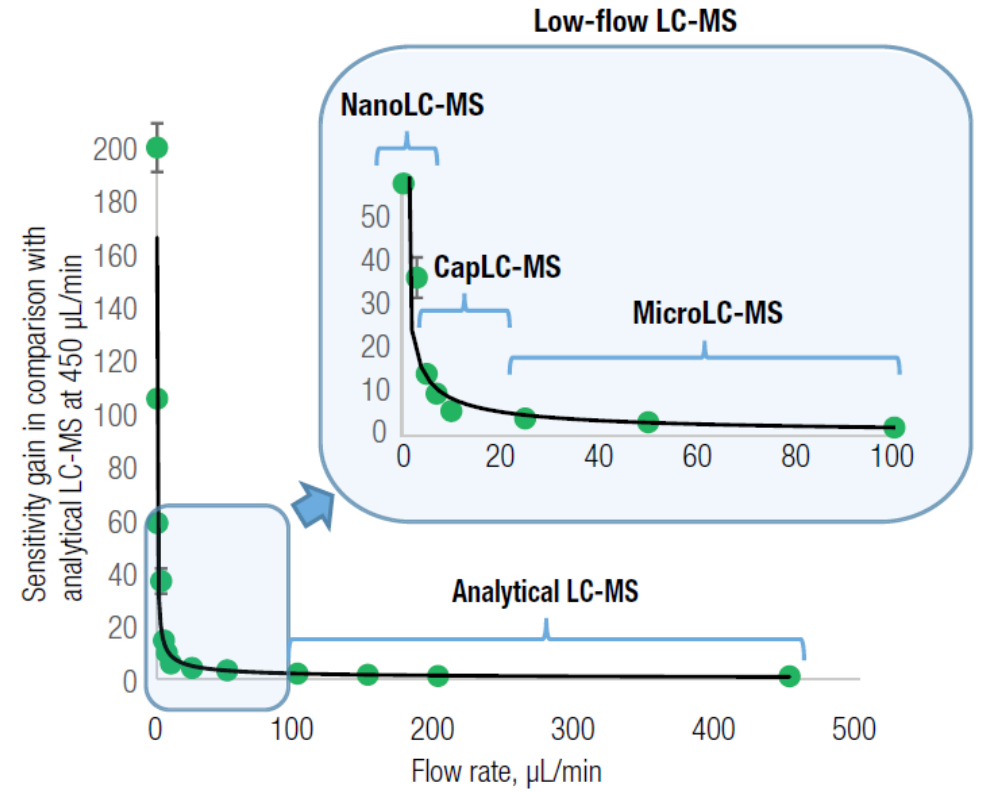
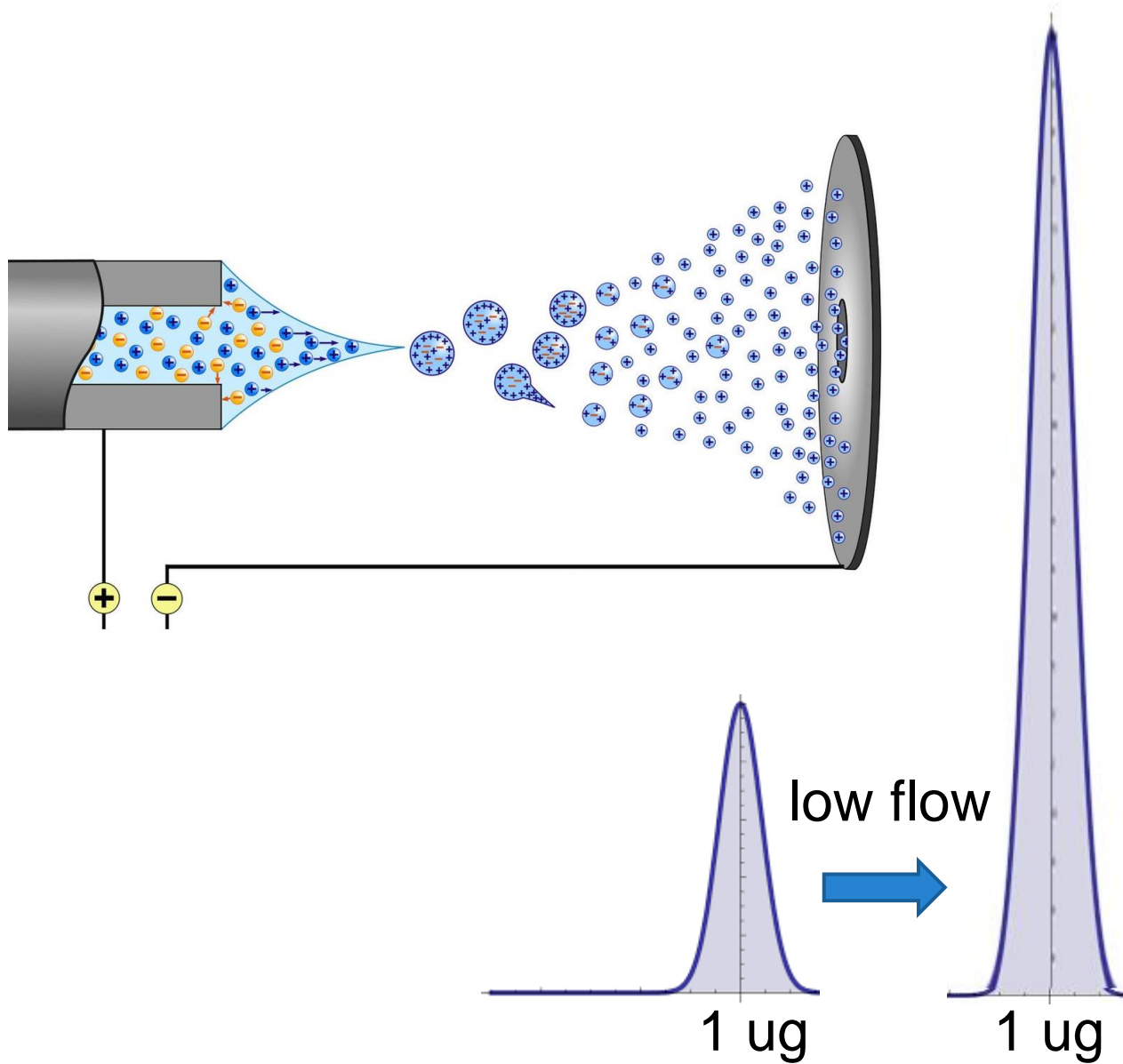

2. Separační technika; HPLC vs. nanoHPLC

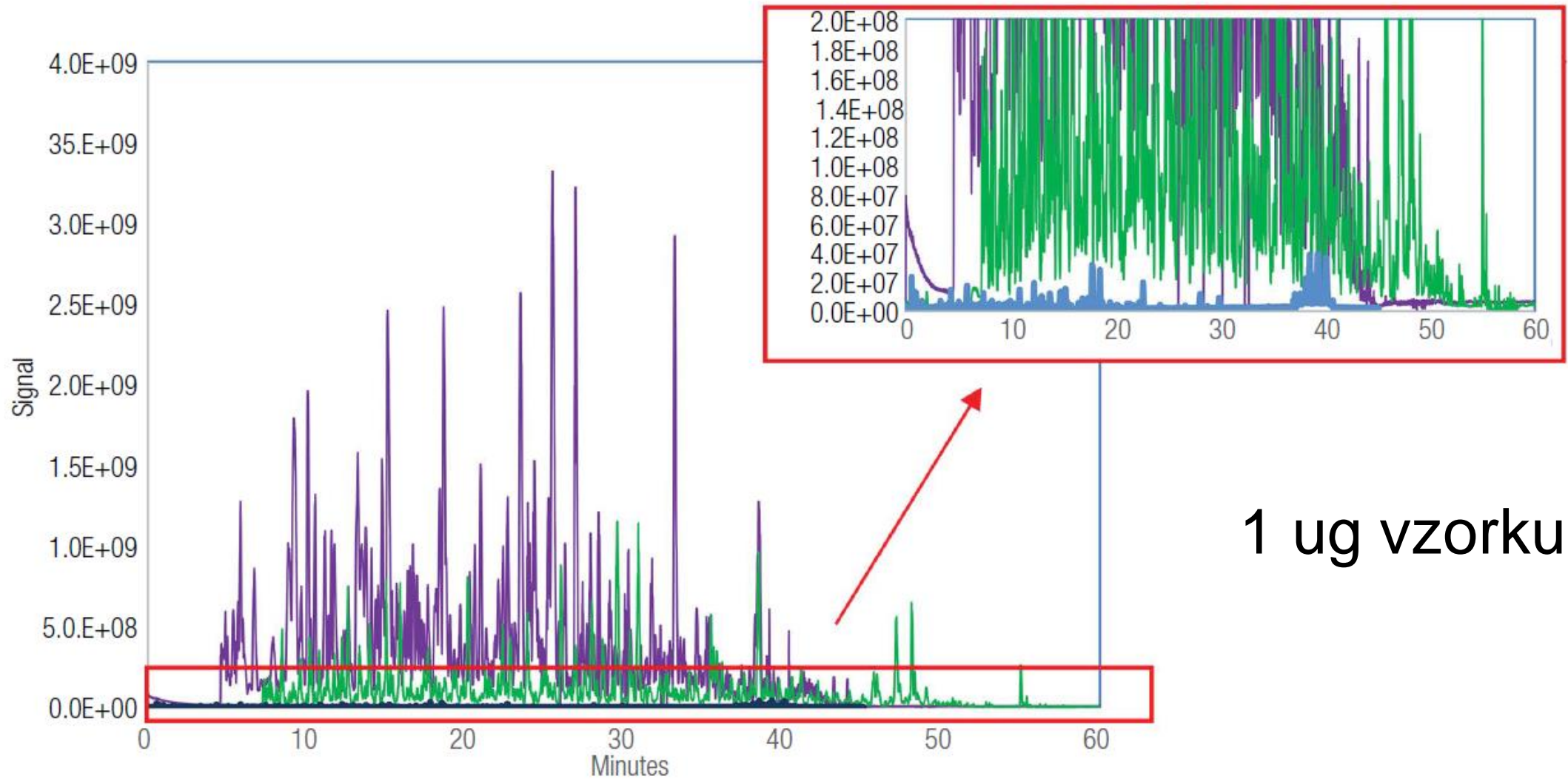

1 ug vzorku



2. Separáčn technika; HPLC vs. nanoHPLC



Ultimate 3000 nano



Evosep One +



2. Separační technika; HPLC vs. nanoHPLC

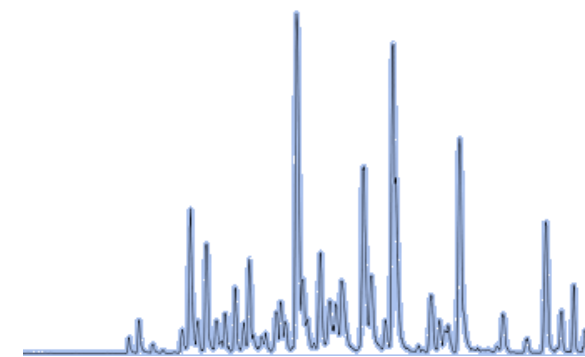
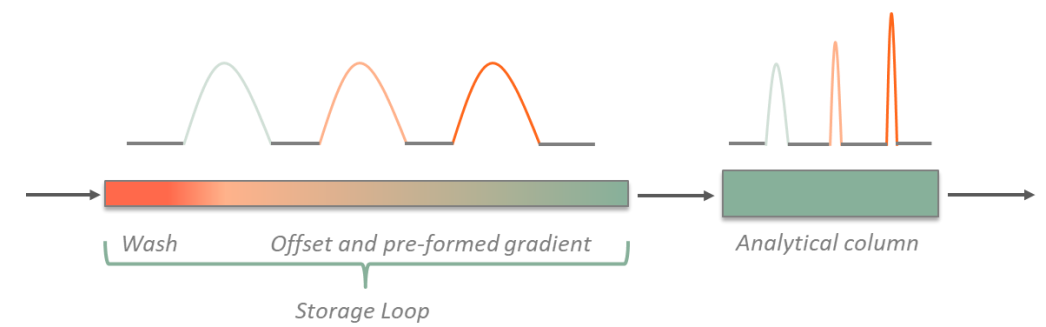
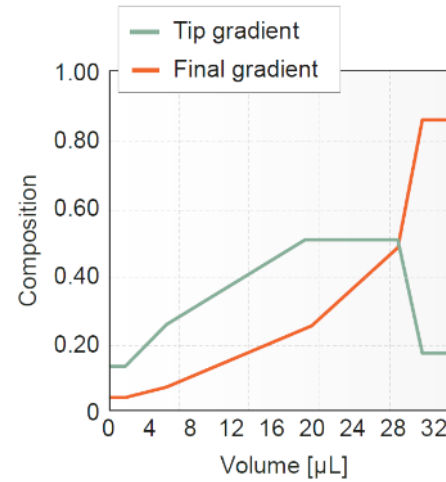
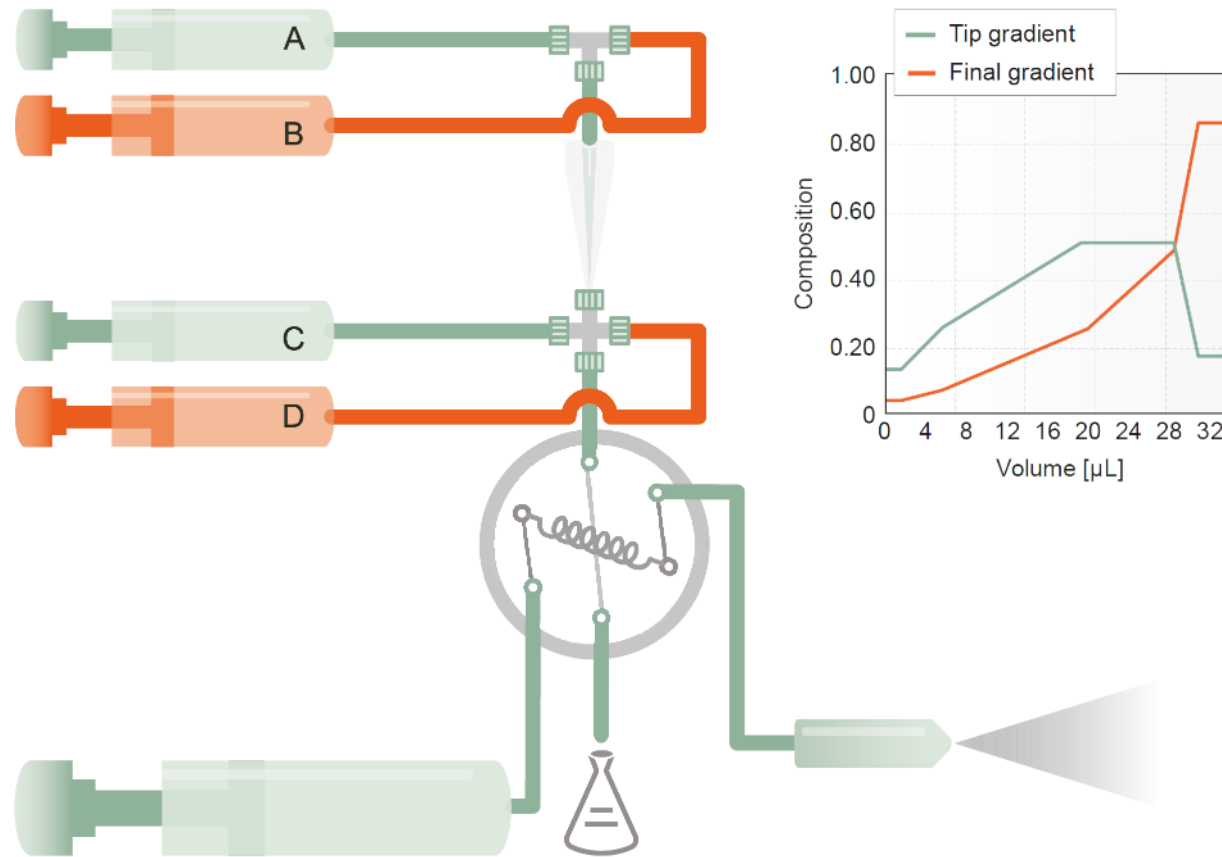

2. Separační technika; CE

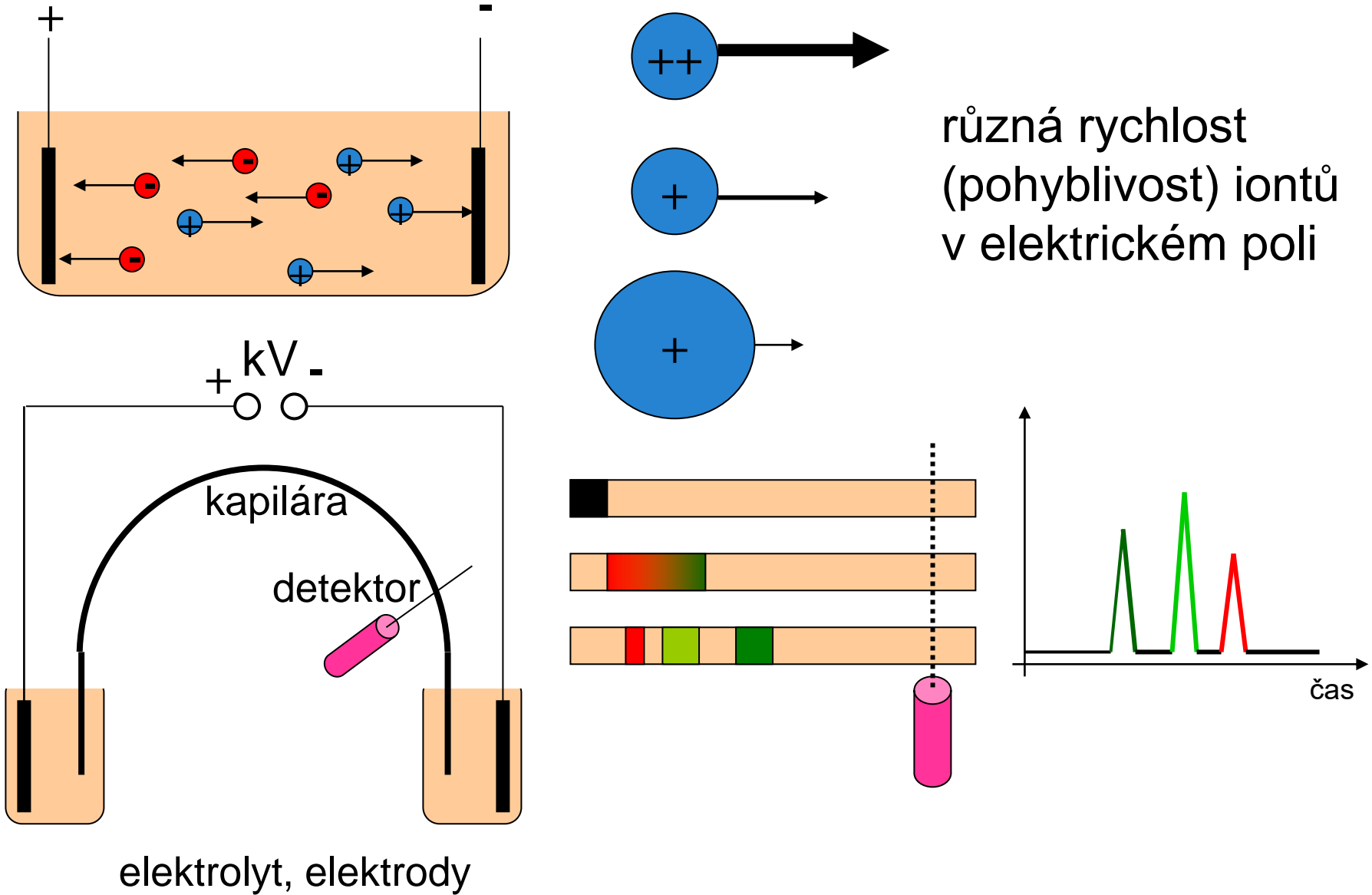

2. Separační technika; CE

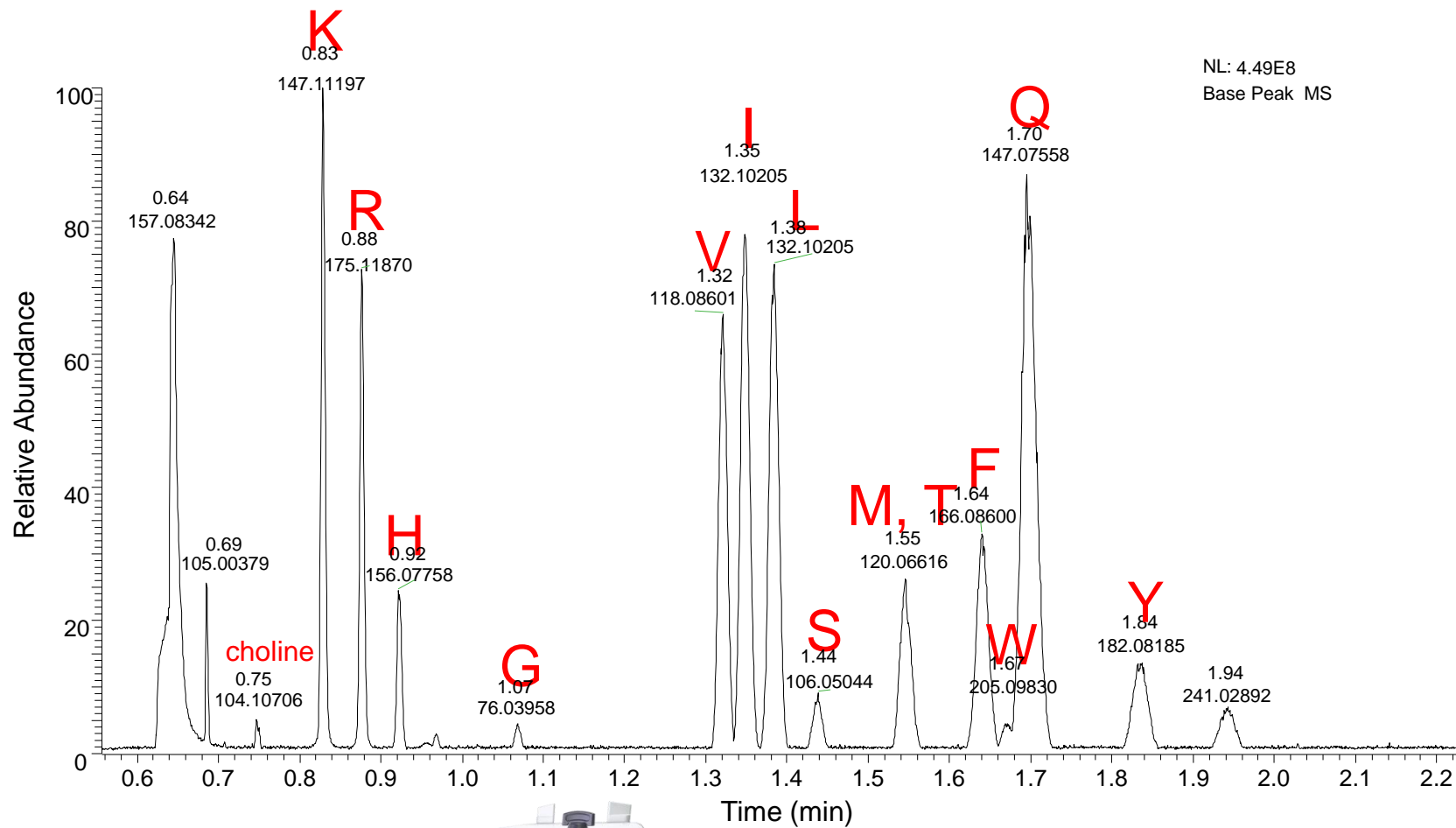
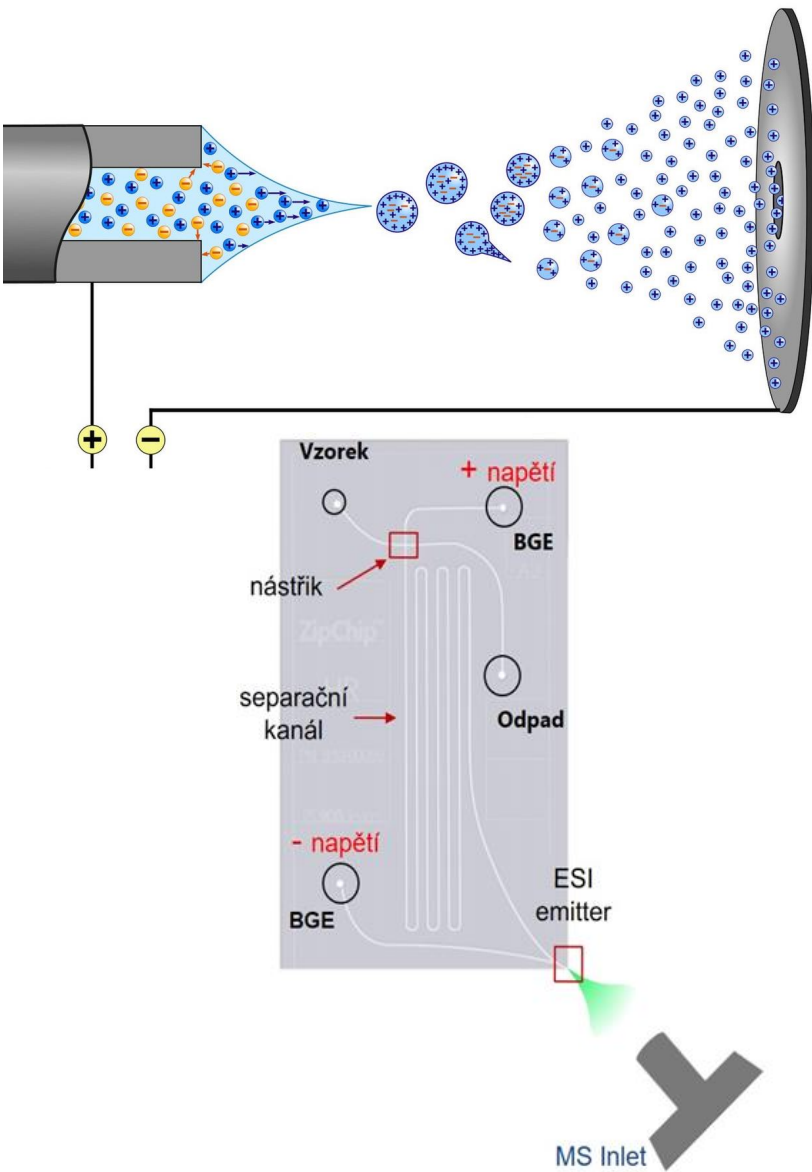

2. Separační technika; FAIMS

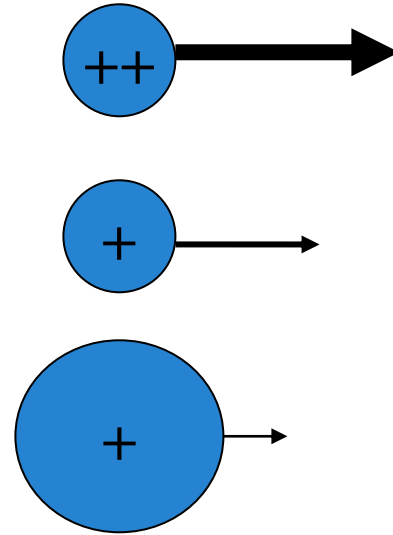
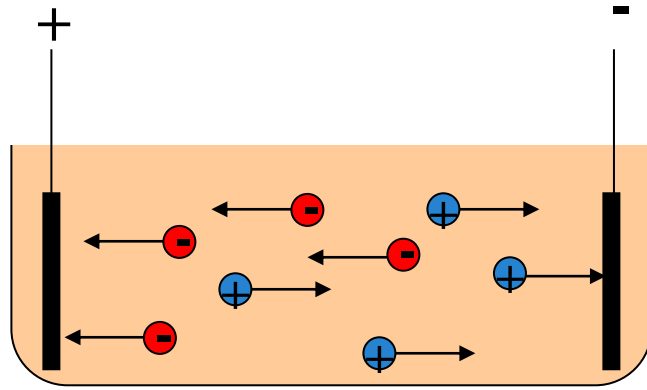

různá rychlost
(pohyblivost) iontů
v elektrickém poli

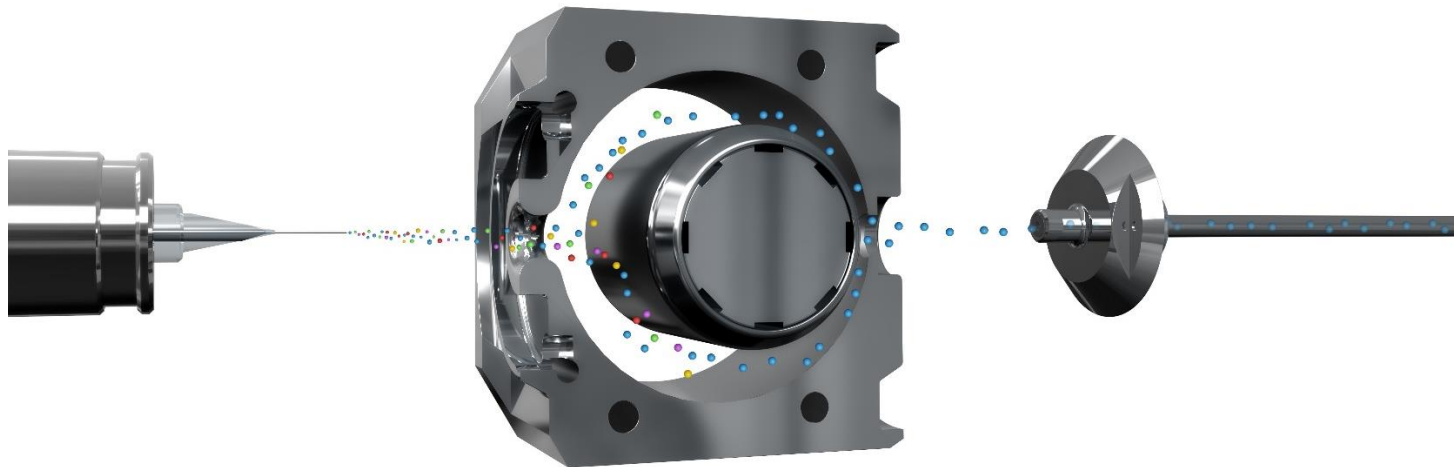

2. Separáčn technika; FAIMS

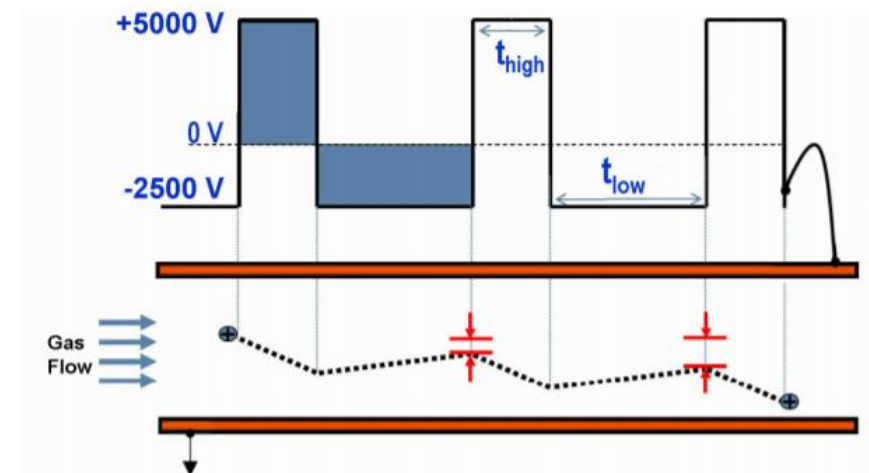
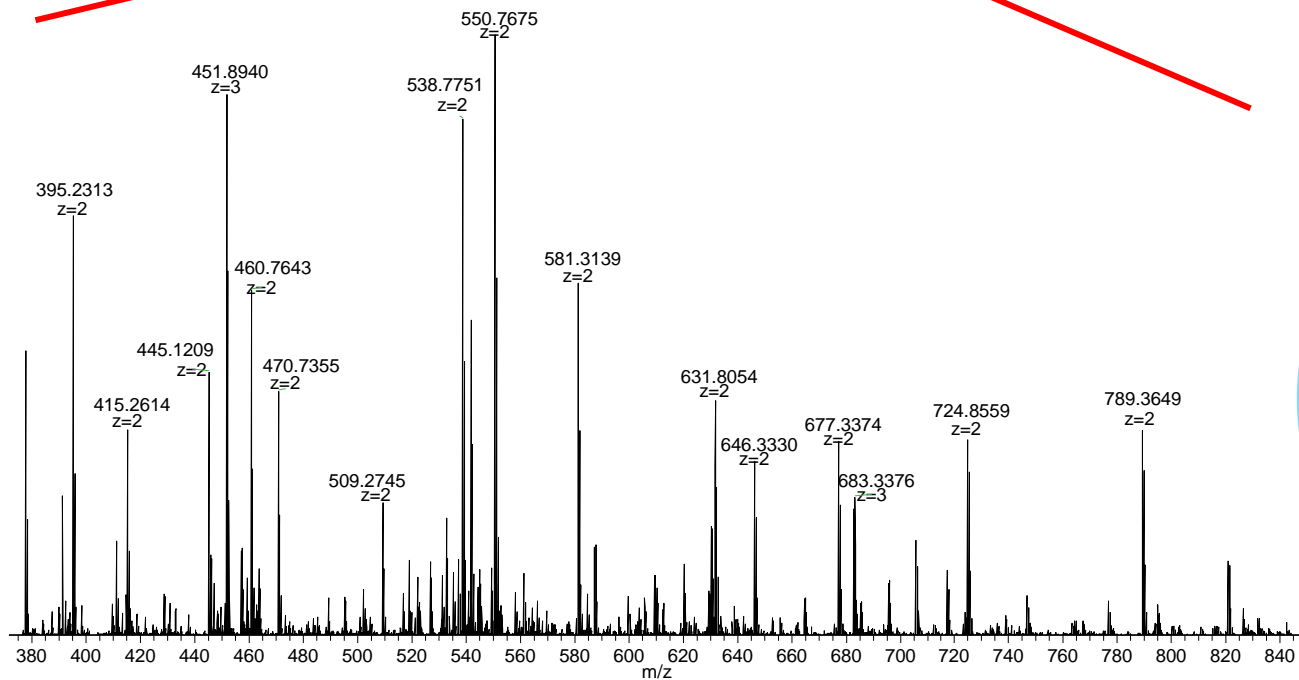
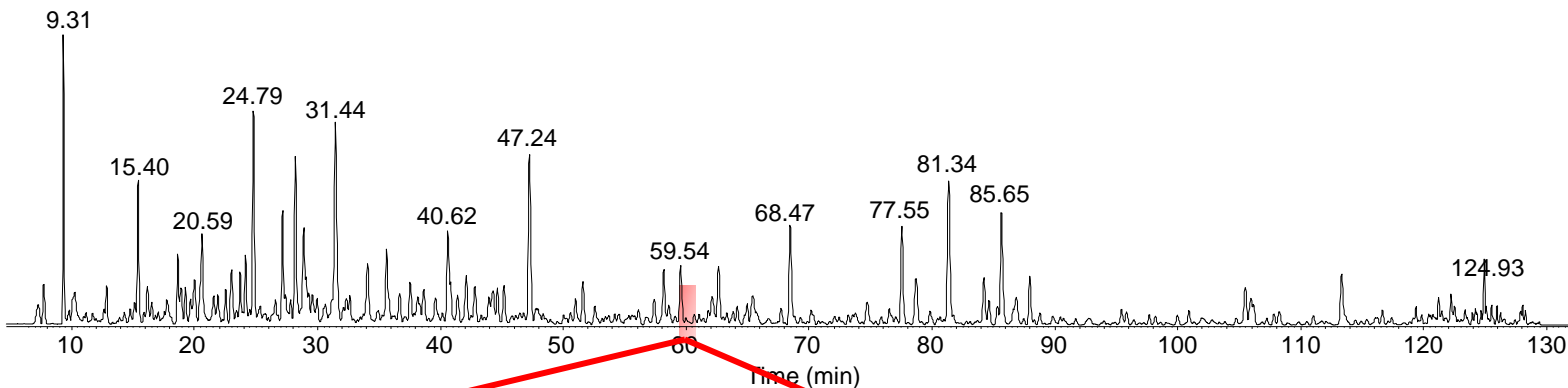

FAIMS

No FAIMS

30 677

77 773

7 300



3. Akviziční nástroje a zpracování

AcquireX

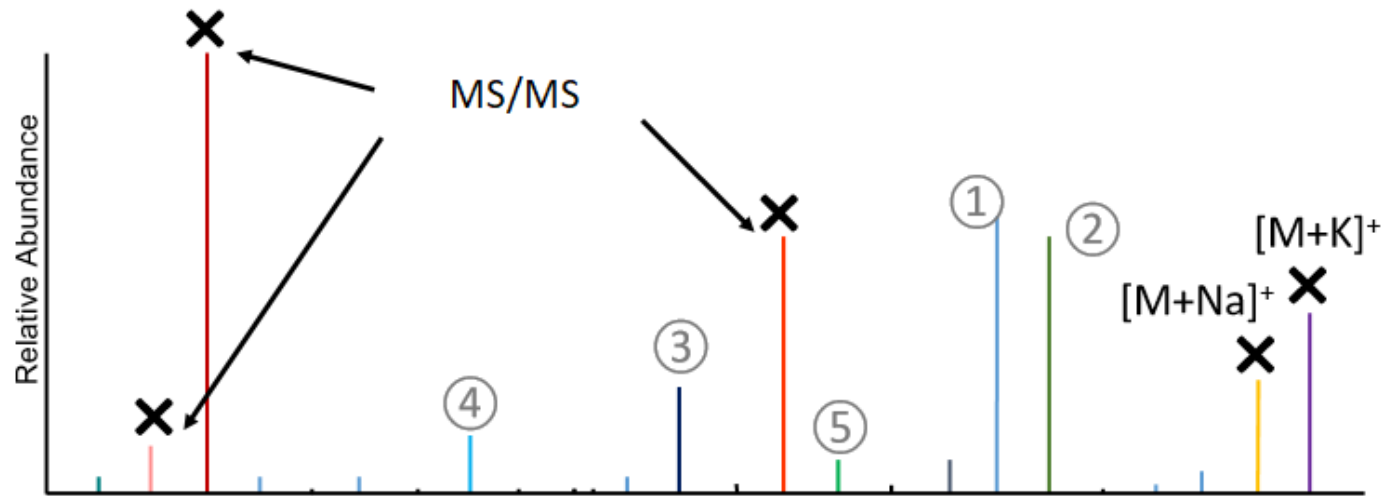

Met-IQ

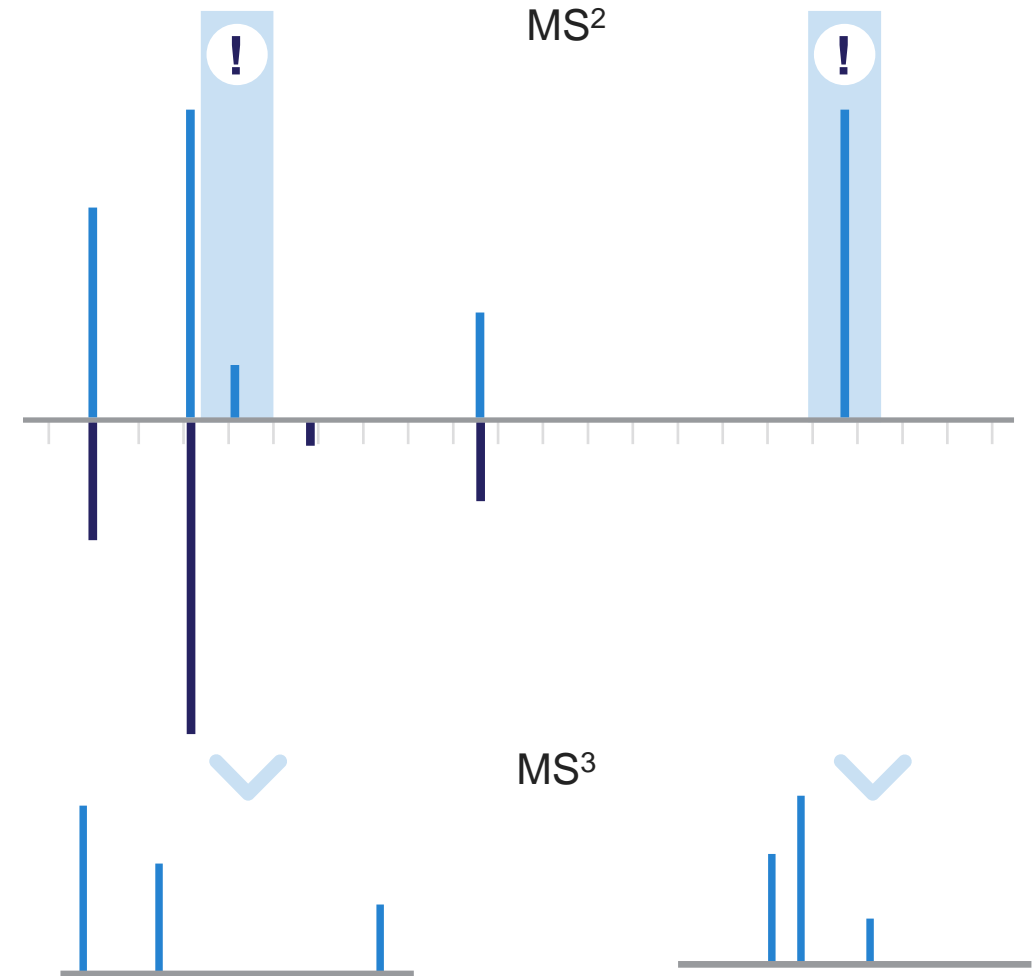

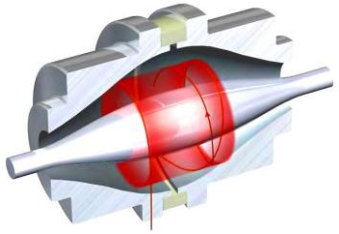

potenciál k masivní expanzi LC-(HR)MS do klinických analýz



> 1%

www.pragolab.cz



[linkedin.com/company/pragolab-s-r-o-](https://www.linkedin.com/company/pragolab-s-r-o-)

