

# NM30LA-MS GAS GENERATOR



## USER MANUAL NM30LA-MS-230v (19" RACK SYSTEM)



Peak Scientific Instruments Ltd.

[www.peakscientific.com](http://www.peakscientific.com)

**UK**

Fountain Crescent  
Inchinnan Business Park  
Inchinnan  
Renfrew PA4 9RE  
Scotland  
UK

Tel. +44 (0) 141 812 8100  
Fax. +44 (0) 141 812 8200  
[info@peakscientific.com](mailto:info@peakscientific.com)

**USA**

19 Sterling Road, Suite #5  
P.O. Box 379  
Billerica  
MA 01862  
USA

Tel. +1 866 647 1649  
Fax. +1 866 647 1649  
[usasupport@peakscientific.com](mailto:usasupport@peakscientific.com)

**INDIA**

Peak Scientific India  
4A, Shantinivas Apts  
12-7-295, Mettuguda  
Hyderabad, 500 017  
Andhrapradesh  
India

Tel. +91 40 2782 0047  
Fax. +91 40 2783 2441  
[indiasupport@peakscientific.com](mailto:indiasupport@peakscientific.com)

Contents

	Page
Contents	2
Document Change History	3
Warranty Statement	4
Declaration of Conformity	5
Technical Specification	6
Introduction	7
Unpacking and Installation Electrical connection	8
Unpacking and Installation and connection	9
Installation – General Controls	10
Installation – Generator Environment	11
Installation - General Dimensions	11
Operation - Principle of Operation	12
Operation - Controls	13
Maintenance - Routine Maintenance	14
Maintenance – Routine Maintenance	15
Maintenance – Routine Maintenance	16
Pneumatic Diagram	17
Maintenance Log	18
Notes - Additional Notes	19

**History**

<b>Rev. No.</b>	<b>Changed</b>	<b>Initials</b>	<b>Date</b>
1	Document Created	GL	09/11/06
2	Waste Bottle Note Added	TG	08/05/07
3	Notes Added for –Indoor use only & Altitude	TG	25/09/02
4	Updated to New Format	SK	06/02/09

## Warranties & Liabilities

### Warranties and Liabilities

1. The Company warrants that it has title to the Goods.
2. Subject to the provisions of this clause the Company warrants that the Goods shall comply in all material respects with any specification referred to in the Order Confirmation (as the same may be amended) and shall, subject thereto, be free from defects in material and workmanship for the lesser of a period of twelve months from the date of delivery or thirteen months from the date of dispatch from the factory.
3. Save as provided in this clause and except where the Goods are sold to a person dealing as a consumer (within the meaning of the Unfair Contract Terms Act 1977) all warranties, conditions or other terms implied by statute or common law are hereby expressly excluded save to the extent they may not be lawfully excluded. When the Goods are sold to a consumer within the meaning of the Unfair Contract Terms Act 1977 their statutory rights are not affected by the provisions of this clause.
4. In the event of the Customer making a claim in respect of any defect in terms of clause 2 hereof the Customer must:-
  - 4.1. reasonably satisfy the Company that the Goods have been properly installed, commissioned, stored, serviced and used and without prejudice to the generality of the foregoing that any defect is not the direct or indirect result of lack of repair and/or servicing, incorrect repair and/or servicing, use of wrong materials and/or incorrect spare parts; and
  - 4.2. allow the company to inspect the Goods and/or any installation and any relevant packaging as and when reasonably required by the Company.
5. Subject to the Company being notified of any defect as is referred to in sub-clause 2 hereof within a reasonable time of it becoming apparent and subject always to the terms of sub-clause 4 hereof, the Company shall, in its option, replace or repair the defective Goods or refund a proportionate part of the Price. The Company shall have no further liability to the Customer (save as mentioned in sub-clause 6 hereof).
6. The Company shall be liable to indemnify the Customer in respect of any claim for death or personal injury to any person in so far as such is attributable to the negligence or breach of duty of the Company or any failure by the Company to comply with the provisions of sub-clause 2 hereof.
7. Save as provided in sub-clause 2 hereof the Company shall not be liable in respect of any claim by the Customer for costs, damages, loss or expenses (whether direct, indirect, consequential or otherwise) or indemnity in any respect howsoever arising including, but not by way of limitation, liability arising in negligence (other than pursuant to clause 6 above) that may be suffered by the Customer or any third party.

### **Caution**

#### **SAFETY NOTICE TO USERS**

**These instructions must be read thoroughly and understood before installation and operation of your Peak Scientific NM30LA. Use of the Generator in a manner not specified by Peak Scientific MAY impair the SAFETY provided by the equipment. When handling, operating or carrying out any maintenance, personnel must employ safe engineering practices and observe all relevant local health and safety requirements and regulations. The attention of UK users is drawn to the Health and Safety at Work Act 1974, and the Institute of Electrical Engineers regulations.**

**WARNING: Nitrogen is not a poisonous gas, but if the concentration in the inhaled air becomes too high there will be a risk of asphyxiation.**

**Declaration of  
Conformity****Declaration of Conformity****RoHS Statement of Compliance**

The European RoHS (Restriction of Hazardous Substances) Directive 2002/95/EC aims to reduce the use of hazardous materials within a certain scope of products – mostly electrical and electronic.

Peak Scientific Instruments Ltd has developed all reasonable 'due diligence' controls, to ensure that our products comply with the principles, and requirements, of this directive. Similar directives in the United States and China, for example, have also been captured within this programme.

Where a specific certificate of compliance is required, this can be requested, on a product serial number basis, from Peak Scientific Instruments Ltd, by contacting us through [info@peakscientific.com](mailto:info@peakscientific.com).

**WEEE Statement of Compliance (WEE/FJ0116XU)**

The WEEE (Waste of Electrical & Electronic Equipment) Directive 2002/96/EC, issued by the European Union, aims to reduce the impact, upon the environment, from disposal of certain types of equipment. It requires producers to implement controls, to ensure that equipment that they produce, is correctly disposed of, following the end of its useful life.

Peak Scientific Instruments Ltd fully complies with it's obligations towards this important legislation. These obligations refer to all electrical equipment that has been dispatched by us from 1st July, 2007, within the United Kingdom. As part of our compliance towards this, we have placed the management of this disposal with the B2B Compliance scheme. They can be contacted directly on 01691-676124, or by visiting their website on [www.b2bcompliance.org.uk](http://www.b2bcompliance.org.uk).

Ken Brown  
Quality Assurance Manager

**Technical Specification**

<b>Generator Environment</b>		
Minimum Operating Ambient Temperature		5 °C (41 °F)
Maximum Operating Ambient Temperature		30 °C (86 °F)
Maximum Relative Humidity		70%
Maximum Altitude		2000 Meters
<b>Outlet Gas</b>		
Maximum Gas Outlet Pressure		100 psig (6.8 barg)
Maximum Gas Outlet Flow		30 Litres /min (ATP)
Start up time for Purity		60 minutes
Particles		0.01um
<b>Electrical Requirements</b>		
@230V±10% ac (50/60Hz)		5.0 Amps
Compressor Circuit Breaker		8.0 Amps
Control Circuit Breaker		2.0 Amps
Electrical Connection		Single Phase Power Cord
<b>General</b>		
Dimensions W x D x H	cm (inches)	60 x 67 x 94 (24 x 27 x 37)
Weight	Kg (lbs)	112.5 (248)
Shipping Weight	Kg (lbs)	169 (372.58)

**Introduction**

**Introduction**

Welcome to the User Manual for the Peak Scientific Instruments NM30LA-MS Laboratory Gas Generator. Enclosed in this manual you will find the information required to ensure that your generator is operated & serviced according to our recommended guide lines which will prepare you for long and trouble free gas generation.

Please review each of the following sections carefully and ensure that the maintenance log at the rear of this manual is updated for future reference.

Thank you for selecting Peak Scientific Instruments (PSI) to meet your Gas Generation needs, and should you require any further assistance or support please do not hesitate to contact us at the addresses on the front cover of this manual.

**Installation****Unpacking and Installation**

Although Peak Scientific takes every precaution with safe transit and packaging, it is advisable to fully inspect the unit for any signs of transit damage.

**ANY DAMAGE SHOULD BE REPORTED IMMEDIATELY TO THE CARRIER AND PEAK SCIENTIFIC OR THE DISTRIBUTOR FROM WHERE THE UNIT WAS PURCHASED.**

Following the un-packing instructions posted on the side of the crate. It will require 2 people to lift the crate clear and to maneuver the generator onto the floor. Thereafter the generator can be moved to its final location on the castors provided.

**NOTE: - Included with the generator is a pack containing keys, manuals, service filters & fittings. Be careful not to discard these with the packing. Please save the product packaging for storage or future shipment of the generator.**

Following installation of the unit, care should be taken to ensure that the waste bottle is **NOT** a sealed container, as this may cause possible pressure build-ups, explosion of the bottle, and consequential damage to the unit. Any bottle used should have a form of exhaust hole, before being fitted to this unit.

**Electrical Connection****Important Electrical Notice**

This unit is classified as **SAFETY CLASS 1** equipment. **THIS UNIT MUST BE EARTHED.** Before connecting the unit to the mains supply, please check the information on the serial plate. The mains supply must be of the stated AC voltage and frequency.

<b>EARTH/GROUND (E):-</b>	<b>Green &amp; Yellow</b>	<b>OR</b>	<b>Green</b>
<b>LIVE (L):-</b>	<b>Brown</b>		<b>Black</b>
<b>Neutral (N):-</b>	<b>Blue</b>		<b>White</b>

**Connect the generator to a single-phase supply using the power cord provided.**



Connections

Rear View.

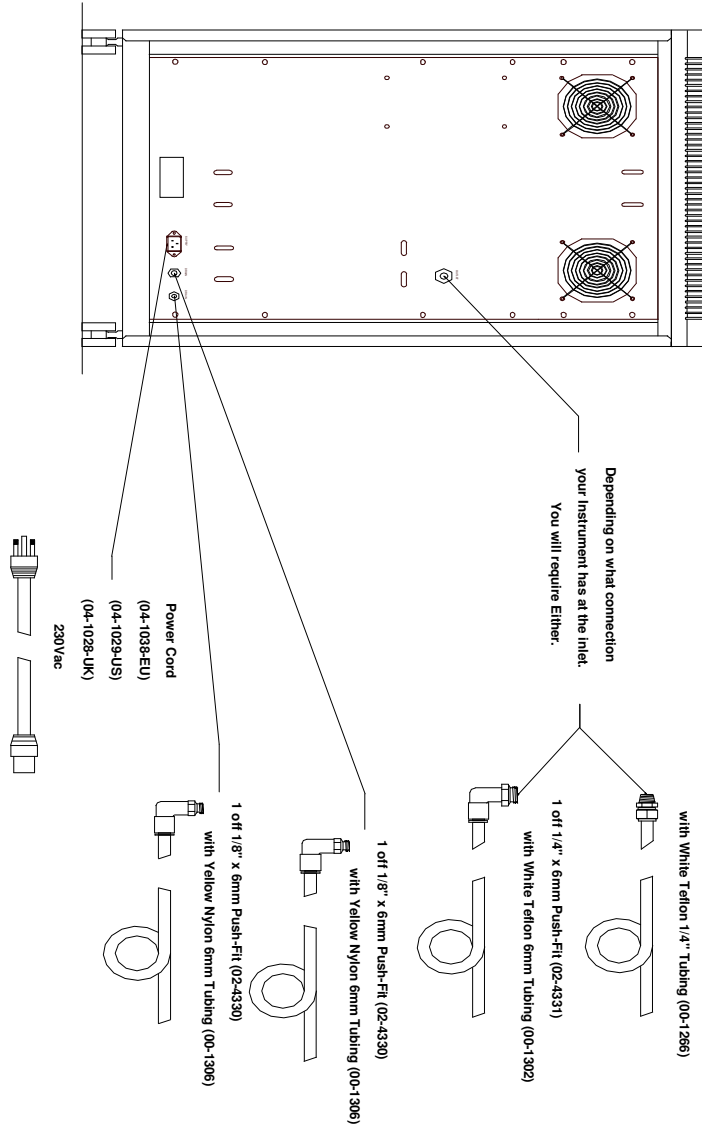

General Controls

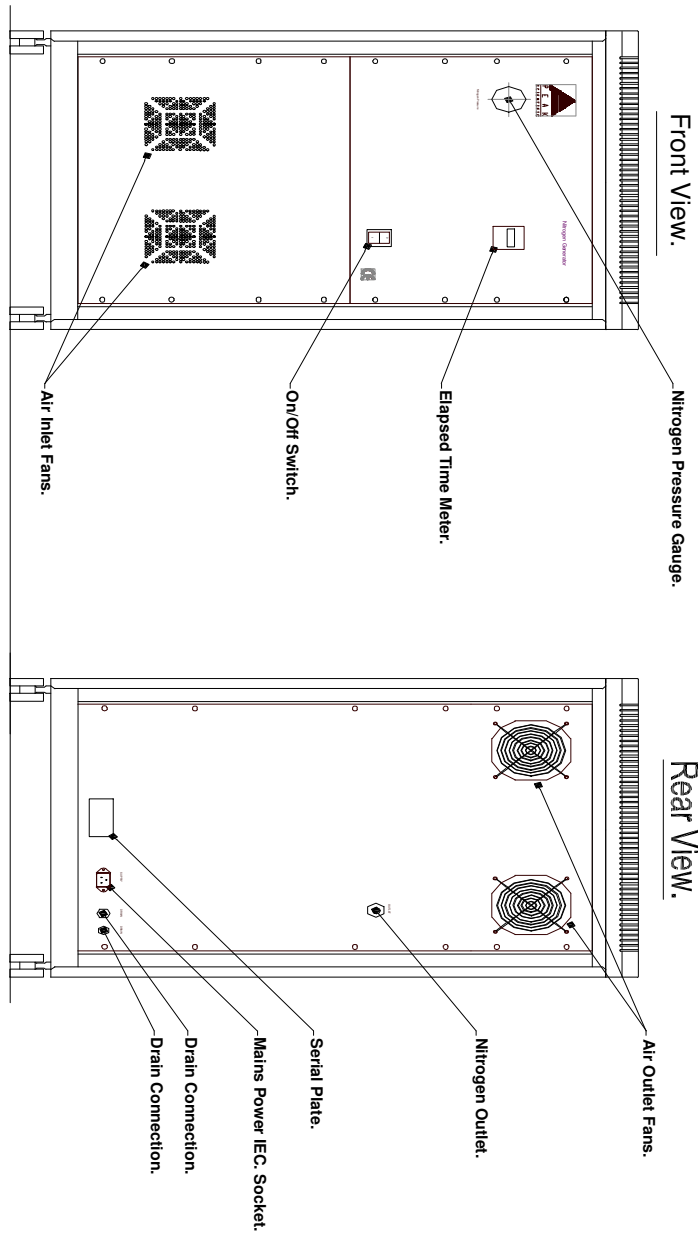

Generator Environment

Generator Environment

The Generator is designed for indoor use only. The unit should be installed adjacent to the Mass Spectrometer it is supplying. If this is not convenient then the generator can be sited elsewhere, however, consideration should be made of the lengths of pipe runs as pressure drops can result from extended runs of pipe.

Performance of the generator (like all sophisticated equipment) is affected by ambient conditions. Continuous operation in ambient temperatures exceeding 25°C will lead to a reduction in capacity and prolonged operation in temperatures exceeding 30°C will shorten the life of the unit.

Note should also be taken to the proximity of Air Conditioning outlets. These can sometimes give rise to 'pockets' of air with high relative humidity. Operation of the generator within such a pocket could adversely affect its performance. Consideration should also be given to the air flow around the unit.

It is recommended that an air gap of 75mm (3") should be maintained down both sides and across the top of the unit. Please refer to the drawing below for the general dimensions of the generator.

MAXIMUM AMBIENT CONDITIONS: - 30°C (dry bulb) 70%RH (Max.)

General Dimensions

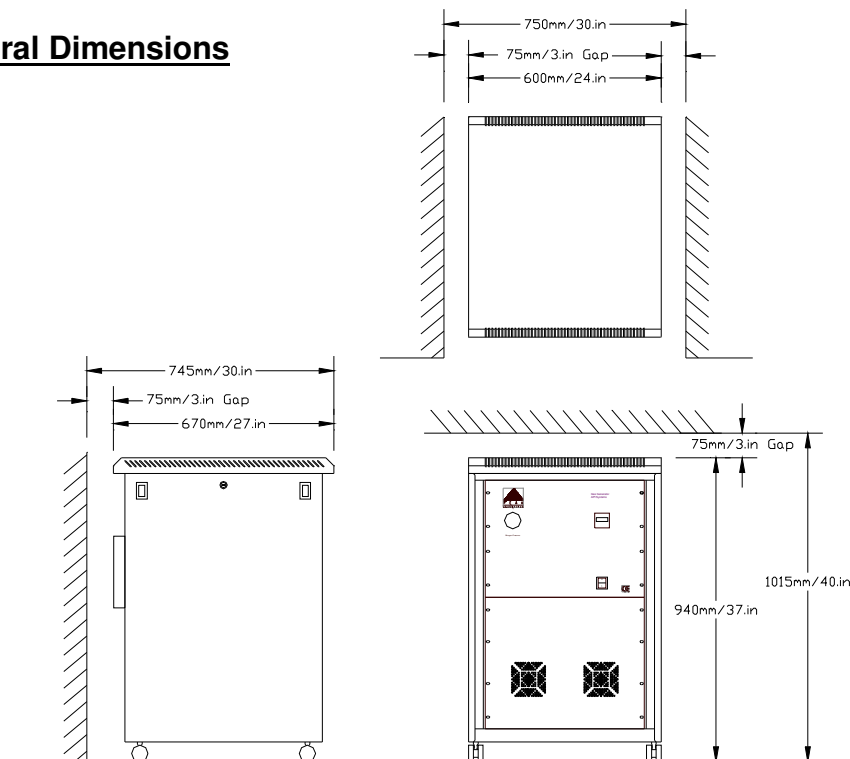

Principle of Operation

Peak Scientific Instruments NM30LA-MS The Nitrogen generator employs “*Hollow Fibre Membrane*” Technology to efficiently separate Nitrogen from other gases present in ambient air. An overview of this process can be seen below.

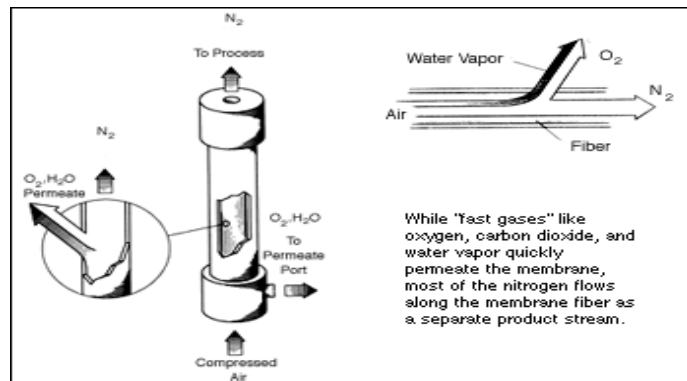

Flow Diagram

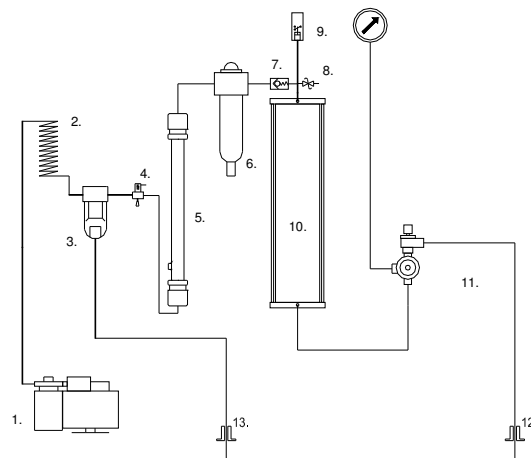

Pneumatic Diagram

Air is drawn into the system by the Compressor (1) and passed through the Cooling Coil (2) and the AFD – 3000 Micro Mist Filter (3) into the Membrane (5). After the Membrane (5) the gas is passed through a Reverse Acting Carbon Filter (6) to remove any remaining impurities and via the Non-Return Valve (Check Valve) (7) into the Receiver (10). The stored gas is regulated (11) to give the required output pressure and flow. Receiver pressure is measured (9) to allow the generator to un-load (4) and shut-down should demand cease. A Safety Relief Valve (8) is fitted to protect the system against over pressure. Gas is delivered out of the machine via the Outlet Port (12). Any moisture collected by the AFD – 3000 Micro Mist Filter (3) is expelled via the Drain Port (13).

**Commissioning****Operator Training**

The NM30LA-MS Laboratory Gas Generator is designed specifically to minimize operator involvement. Given that the generator is installed as described in earlier sections and is serviced in accordance with the following maintenance recommendations then it should simply be a matter of turning the generator on. The generator will automatically produce the factory default flow and pressure noted below.

**NITROGEN OUTLET                      30 litres per min (ATP)      100 PSI.G (680kPa)**

Should the demand for gas be less than the rated flow then the generator will automatically regulate the internal pressure and cycle of the compressors as required. This should be all the input your generator requires from you, the only additional tasks required are,

If at any time the generator begins to emit excessive noise or vibration, then it should be switched off and you should contact your local representative or the factory as soon as possible.

Please ensure that both the drain ports at the rear of the generator are led to a suitable connection or container.

It should be noted that the generator will liberate considerable amounts of water from these ports (approx. 1-2 litres weekly). If a container is used it should be emptied at regular intervals.

Ensure that the generator is serviced in accordance with the following maintenance recommendations.

Maintenance Schedule

**Routine Maintenance**

**Servicing and/or repair of the Generator should only be undertaken by a TECHNICALLY COMPETENT PERSON, with the generator in its safely isolated condition.**

**SAFELY ISOLATED CONDITION**

Definition: The unit is in a Safely Isolated Condition when it is disconnected from its application, fully de-pressurised and isolated from the Electrical Supply. Directions for isolating the generator are shown below.

**Isolating the Generator:**

- a) Switch off the unit.
- b) Disconnect the unit from the mains supply.
- c) Ensure the internal pressure gauges (page 12) reads zero. (If gauge does not fall to zero, loosen outlet fitting slightly to allow trapped gas to escape).
- d) Disconnect from the application

**Maintenance Schedule**

SERVICE INTERVAL	COMPONENT	PART NO.		
1 YEAR	AFD3000 FILTER ELEMENT (AFD) x 2	02-4335		
	RAC FILTER ELEMENT x 1	00-4425		
EVERY 6 MONTHS	INLET FILTER (x4)	02-4187		
<b>ANNUAL SERVICE KIT</b>	<b>ALL PARTS LISTED ABOVE</b>	<b>08-4435</b>		
COMPRESSOR (THE LESSER) UNIT 6000 HRS OR 18MONTHS	2750 COMPRESSOR	08-1425		
	2688 COMPRESSOR	08-1420		
	COMPRESSOR TRAY ASSEMBLY (x1)	08-4649		
*ALTERNATIVE TO COMPRESSOR ASSY.	2750 COMPRESSOR RE-FIT KIT (X1)	06-5529	on Request	
	2688 COMPRESSOR RE-FIT KIT (X1)	06-5542		

Note:

\*Compressors can be re-fitted as an alternative to replacement up to a maximum of 3 times, this is a more cost effective solution, however a degree of technical expertise is required and can be time consuming.

Service kits are available for all routine maintenance. Please contact Peak Scientific for further details.

Maintenance

**RAC Filter**

The Element is as shown, and should be changed at 12-month intervals.

**The Power supply to the Generator MUST be turned OFF and the Generator MUST be de-pressurised prior to attempting to remove ANY filter bowl. Failure to do this may cause injury.**



RAC FILTER Element  
(00-4425)

The filter housing is removed by un-screwing in a counter clockwise direction

**AFD3000 Filter**

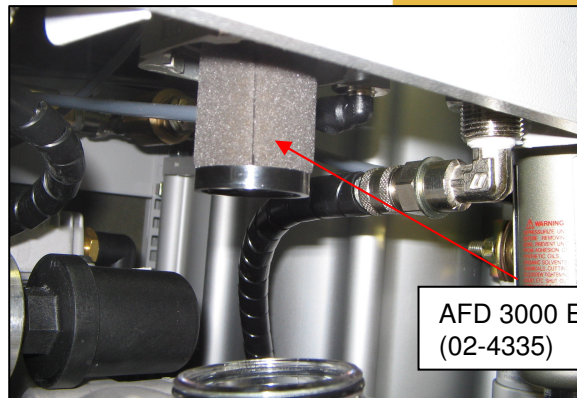

AFD 3000 Element  
(02-4335)

The filter housing is removed by pulling the black clip and turning the Bowl 1/4 Turn either direction

Maintenance

Compressor Intake Filter

The Element is as shown, and should be changed at 6-month intervals.

**The Power supply to the Generator MUST be turned OFF prior to attempting to remove ANY filter. Failure to do this may cause injury.**



Compressor 2750 Intake filter

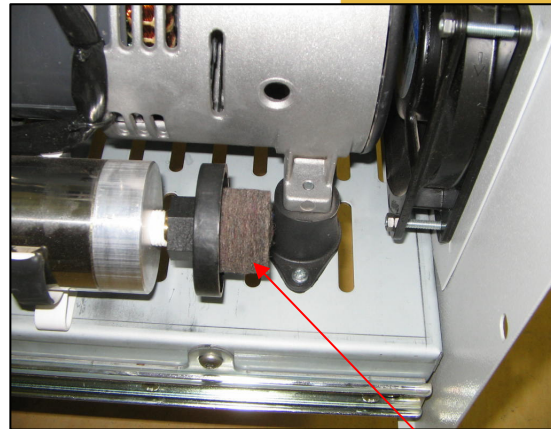

Filter Element  
PAD 02-4187

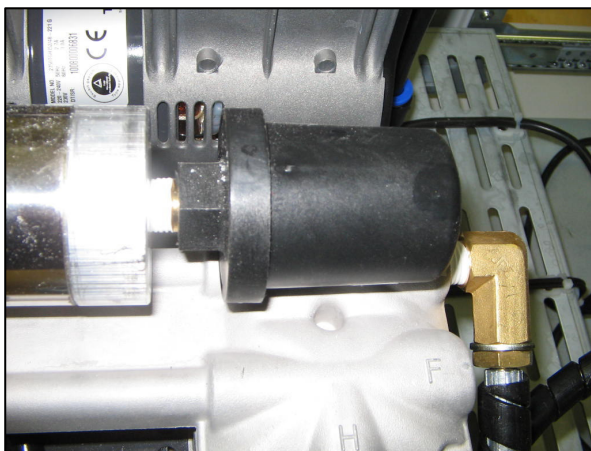

Compressor 2688 Intake filter

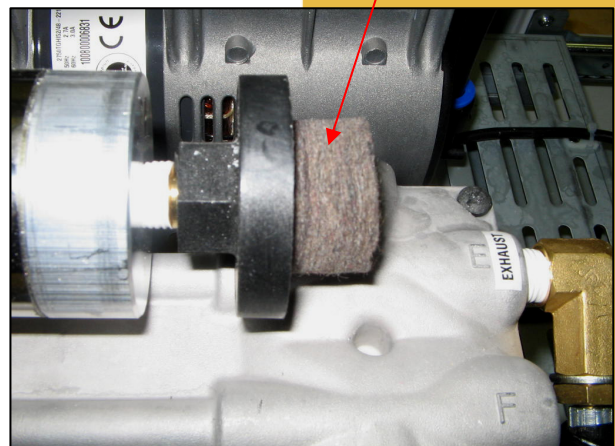



Pneumatic

**Pneumatic Diagram**

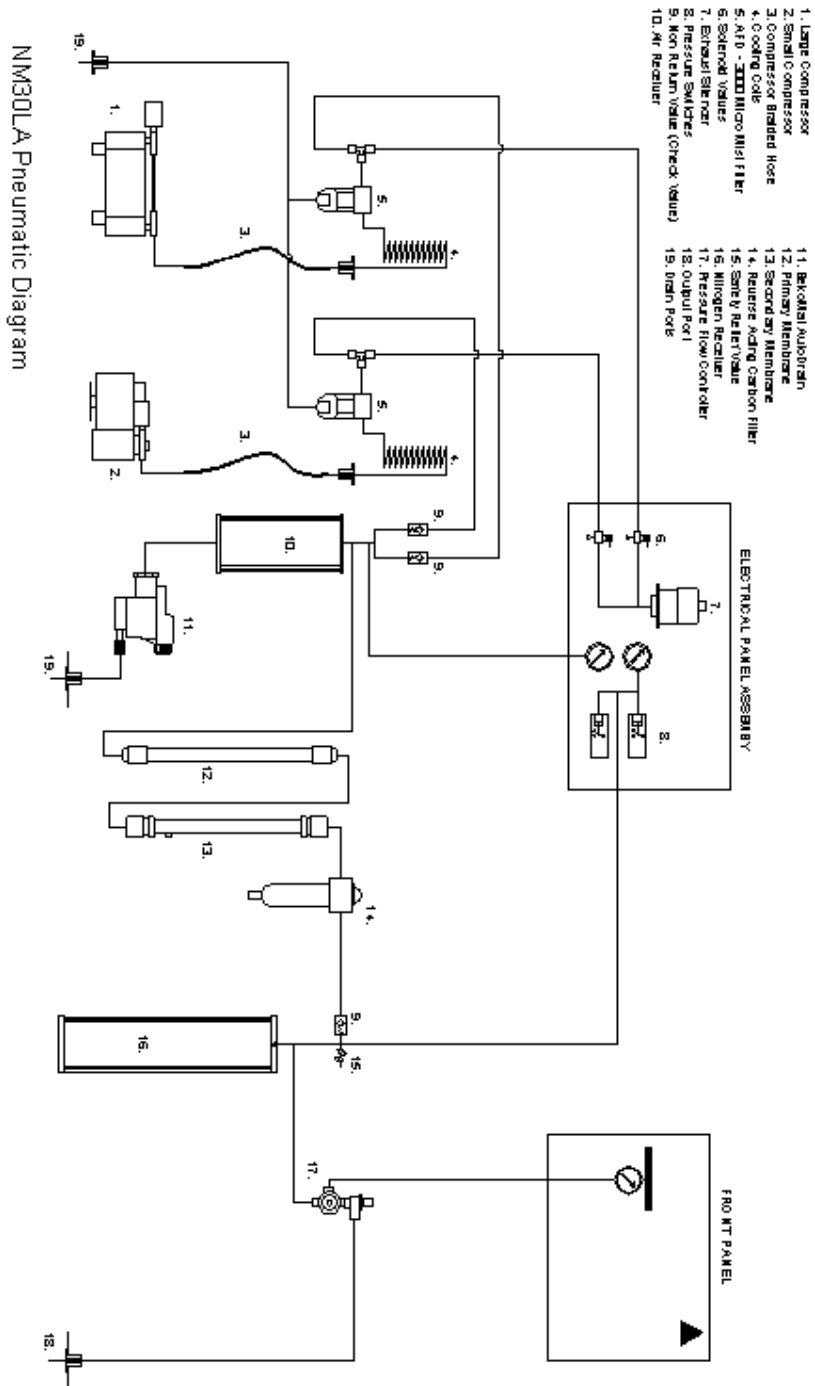

Maintenance log

### Maintenance Log

Model- NM30LA

Serial number \_\_\_\_\_

Work Done	Remarks	Date	Name

**Notes**