

Solutions for  
**Cellulose Nanofibers**

Application Notebook



# Solutions for Cellulose Nanofibers

Application Notebook

## Introduction

Cellulose nanofibers (CNF) are plant-derived carbon-neutral materials which are light-weight and strong, yet they also exhibit high elasticity and resistance to heat. Furthermore, the main component of CNF, cellulose, can be biosynthesized in large quantities through photosynthesis and it is abundantly available in nature. With recent concerns on global warming and climate change, there is a growing attention regarding CNF playing a major role in sustainable bio-based materials and may be one of the fundamental solutions to various environmental problems. This is not a far-fetched goal as new technologies has been developed in the recent decade to improve the efficiency of CNF production and investigation.

As a consultant for comprehensive analysis of CNF, Shimadzu aim to support research and development to expand the use of CNF. By developing cutting-edge technologies, Shimadzu provides solutions for detailed analysis of CNF properties such as optical transmittance morphology, dispersibility, and different surface functional groups. These analyses are further explored in this booklet comprehensively to help you better investigate and characterize nanocellulose materials. These efforts will help accumulate more experimental, theoretical and analytical data, fostering collaborations to help advance this field forward for practical applications in the near future. Shimadzu will help realize dreams for the next generations with the well-being of mankind and the Earth.

## Ready for the *NEXT ERA*

**UV-2600**  
UV-VIS Spectrophotometer



**NEXERA SERIES**  
HPLC Systems



**IRSpirit**  
Infrared Spectrophotometer



**SPM-9700HT**  
Scanning Probe  
Microscope



**IG-1000**  
Single Nano Particle  
Size Analyzer



**SALD-7500**  
Nano Particle Size Analyzer

**iSpect DIA-10**  
Dynamic Particle Image  
Analysis



# Solutions for Cellulose Nanofibers

Application Notebook

## Joint Contributors



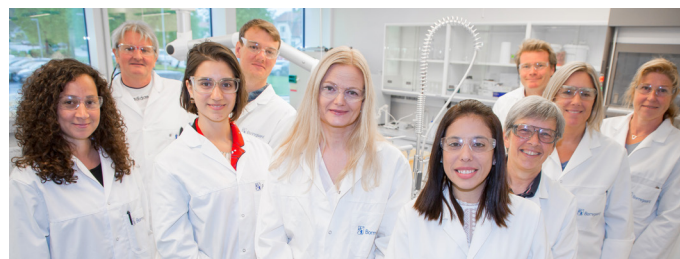
Prof. Akira Isogai  
Bionanomaterials & Cellulose Science  
Department of Biomaterial Sciences  
The University of Tokyo

A handwritten signature of Prof. Akira Isogai in black ink.

“  
More data of CNFs from various aspects under various conditions should be accumulated to further expand the practical productions and applications of CNFs.

Plants produce cellulose nanofibers (CNFs) ~3 nm and several  $\mu\text{m}$  in width and length, respectively, in their cell walls from  $\text{CO}_2$  and water by photosynthesis. The  $\text{CO}_2$ -accumulated CNFs behave like reinforcing steels and cause the high strengths of plant bodies against gravity or weather. In this century, fundamental and application researches related to CNFs have been carried out extensively worldwide, because CNFs are bio-based and promising nanomaterials produced from abundant and renewable plant biomass recourses.

Numerous scientific publications and patents have been reported up to date, and these numbers are still increasing. Some CNF films have unique mechanical, optical, oxygen-barrier, electronic, and thermal properties, which are required for high-tech materials and devices. When CNFs are mixed with plastics under suitable conditions, extremely strong but light nanocomposite materials can be obtained, which are applicable to automobile bodies and housing materials for building construction. However, more fundamental and theoretical data of CNFs from various aspects under various conditions should be accumulated to further expand the practical productions and applications of CNFs. Moreover, establishment of reliable analytical methods/techniques for CNFs with various nano-sized morphologies is required for scientific interpretation/improvement of various CNF-related experimental data.



## Borregaard

Borregaard produces advanced and environmentally friendly biochemicals that replace oil-based products. Borregaard is also a leading producer of cellulose fibrils, including Exilva Cellulose Nano Fibrils, and have launched the world's first commercial plant for producing this product.

## Industrialization and practical use of Exilva

Exilva microfibrillated cellulose is giving functionalities relating to rheology, stability and film forming. It can build yield stress, combined with a sharp and defined yield point. This is providing you with a very efficient additive for stability. Exilva is used for stabilizing e.g. coatings, adhesives, agricultural chemicals. The shear thinning behaviour makes it very suitable for controlling spray behaviour and stability in chemical formulations. Consequently, Exilva can give benefits like anti-settling, anti-sag, anti-sedimentation, improved spraying, and film forming.

## Outlook for the future of CNF

Some sources are expecting the market for cellulose fibrils to surpass USD 1 billion by 2024. The interest in this product is very high from the industry and the sustainability profile this product delivers is fitting well with the increased demand for bio-based additives.

## Expectation for analysis and measurement

We encourage further development of measurement methods to determine individual fibril size and distribution as well as aspect ratio of dispersed CNF. Other properties such as morphology and surface charge and potential is also of high interest. Continuous measurement of coalescence behavior would be very helpful for understanding and development of applications for CNF. Furthermore, it will be highly beneficial to relate advanced and time consuming measurements to less complex in-line or lab measurements to facilitate faster CNF market growth.



Dr. Hans Henrik Øvrebø  
Chief Technology Officer  
Borregaard Group

A handwritten signature of Dr. Hans Henrik Øvrebø in black ink.

## Raw material of CNF

### Morphology for Fiber Disintegration Process

Scanning Probe Microscope - Morphology Observation of Cellulose Nanofiber Obtained by Mechanical Defibrillation.

## Original properties for CNF

### Optical Transmittance and Surface Functional Groups

UV-Vis spectrophotometry and FT-IR - An Evaluation of Dispersibility and Functional Group Information of Networked CNFs and the Optical Properties of CNF Film.

### Morphology, Width and Length

Scanning Probe Microscope - Observation of Cellulose Nanofibers and Measurement of Fiber Length/Width.

### Advanced Morphological Observation and Measurement

Scanning Probe Microscope - Automatic Measurement of fiber length and width.

### Dispersion and Fiber Length in Aqueous Solution

Particle Size Analysis - Evaluation of dispersibility and fiber length without drying.

### Crystal structure

X-ray Diffractometry - Measurement of Degree of Crystallinity of Cellulose Nanofiber.

### Multi-measurement application

UV, Scanning Probe Microscope and Induced Grating method - Evaluation of Fiber Length and Dispersibility of Mono-Dispersed Cellulose Nanofibers.

## CNF reinforced composites

### Morphology and Mechanical properties

Scanning Probe Microscope - Observation and Characterization of Dispersion State of Cellulose Nanofibers and Polymer Composite.

### Viscosity of Composites

Constant Test Force Extrusion Type Capillary Rheometer Flowtester - Viscosity Evaluation of Cellulose Nanofiber Reinforced Composites.

### Mechanical Strength of Composite

Universal Testing Machine - Point Flexural Test of Cellulose Nanofibers Reinforced Plastics.

## Characteristics of individualized cellulose nanofibril samples that are required to be measured or identified and their measurement methods

Characteristics	Measurement Methods	Instrument
Morphology	AFM	SPM-9700HT
Width, height and length	AFM	SPM-9700HT
Optical transmittance	UV-Vis spectrophotometry	UV-2600, UV-1900
Surface functional types	FT-IR	IRTracer-100, IRSpirit
Thermal stability	TGA	TGA-50
Constituent sugar content	HPLC	Nexera Series
Acid-soluble metal content	ICP, ICP-MS	ICPE-9820, ICPMS-2030
Crystal structure	X-ray diffractometry	XRD-7000

[Click here to inquire more](#)

# Application News

## No. S32

### Surface Observation

## Morphological Observation of Cellulose Nanofiber Obtained by Mechanical Defibrillation

### Introduction

Cellulose is a polysaccharide consisting mainly of plant cell walls. Nanocellulose is produced by defibrating cellulose to the nanometer size. Nanocellulose with a width of 4 to 100 nm, length of approximately several  $\mu\text{m}$ , and high aspect ratio (100 or more) is called cellulose nanofiber (CNF), and is a focus of attention as an advanced new biomass material.

In addition to light weight and high strength, CNF also offers outstanding functions such as a high gas barrier property, adsorption, and transparency. Moreover, because CNF is a plant fiber-derived material, the environmental impacts associated with production and disposal are small. Application to automotive, electronic, packaging and other materials is expected in the future. Because CNF is produced by the grinder method, in which cellulose is mechanically defibrated, optimization of the defibrillation conditions is required for efficient production of larger quantities of CNF. Therefore, morphological observation was performed focusing on the fibers in the defibrillation process, which had not been considered important in the past. This article introduces an example of morphological observation of fibers during the mechanical defibrillation process using a scanning probe microscope (SPM) and laser scanning microscope (LSM).

E. Iida

### Instruments Used in Observation

SPM enables high magnification observation of the three-dimensional (3D) profile and local physical properties of samples by scanning the sample surface with a microscopic probe (observation range: several tens nm to 125  $\mu\text{m}$ ). LSM enables noncontact, wide-range observation of the 3D profiles of samples (observation range: 16 to 2560  $\mu\text{m}$ ). Fig. 1 shows the appearance of the instruments.



Fig. 1 OLS Series 3D Measuring Laser Microscope (left), SPM-9700HT™ Scanning Probe Microscope (right)

### Morphological Observation of Fibers During Defibrillation

Samples were prepared by defibrating a broadleaf tree pulp sheet a maximum of five times by the grinder method, followed by dispersion in water. Because the concentration and viscosity of the samples are high in the defibrated state, the fibers were diluted 400 $\times$  with water after each defibrillation treatment, and were observed after dripping/drying on a cleaved mica surface. Due to the large size of the untreated fibers and fibers after one treatment, these fibers were observed by LSM (observation field: 260  $\mu\text{m}$   $\times$  260  $\mu\text{m}$ ). Fibers after two to five treatments were observed by SPM, and the average fiber diameters were calculated (observation field: 10  $\mu\text{m}$   $\times$  10  $\mu\text{m}$ ). Fig. 2 shows the observation results. Although the untreated fibers are in a bundled condition, it can be seen that the fibers unravel and become progressively finer as defibrillation treatment proceeds. Since the decrease in the average fiber diameter from the 2nd treatment to the 3rd treatment was particularly large, it is thought that the largest defibrillation occurs in this process.

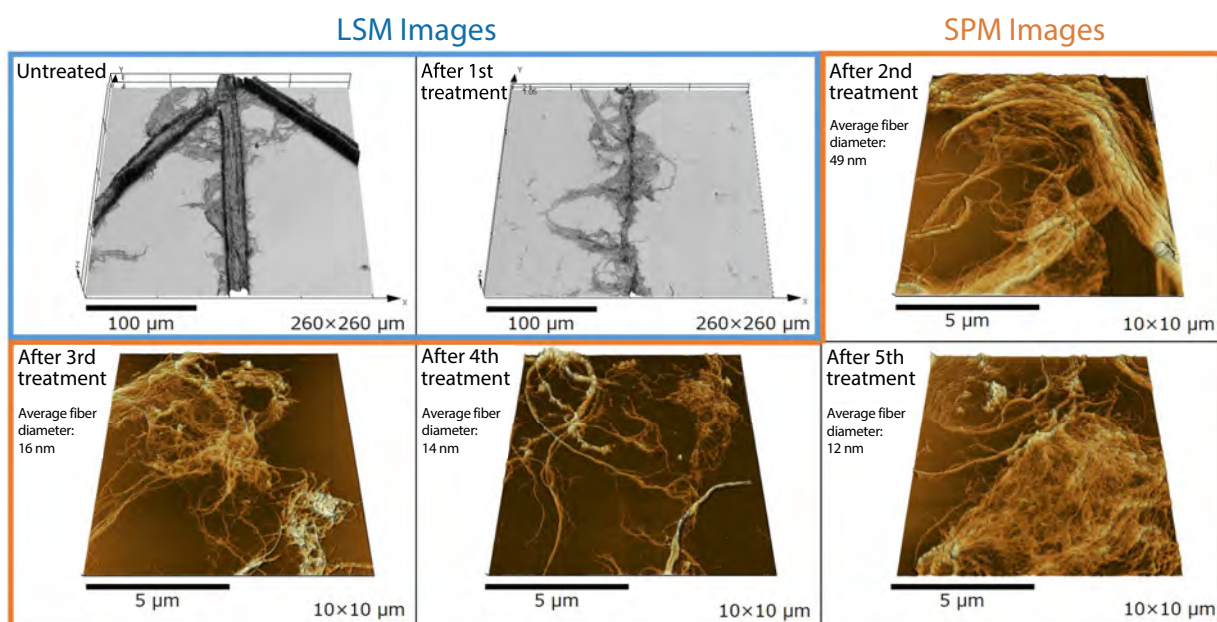


Fig. 2 Images of Fiber Shape and Average Fiber Diameter After Each Stage of Defibrillation Treatment

### High Resolution Observation of CNF

The fibers obtained by performing defibrillation treatment five times (Fig. 2, lower right) were observed with high resolution by SPM (observation field: 250 nm × 250 nm). Fig. 3 shows the result (high resolution observation region: area outlined in red in figure at left). The shape of the CNF can be seen clearly in Fig. 3.

The cross-sectional profile was analyzed in order to measure the fiber diameter of the CNF. With SPM, the height value is generally used as the fiber diameter because the sample profile width is observed as larger than the actual size due to effect of the probe shape. From Fig. 4, it can be understood that the fiber diameter of the CNF is on the order of 4 nm (red box in Fig. 4). This demonstrates that individual CNF fibers can be captured by high resolution observation.

### Conclusion

The morphological changes in CNF due to mechanical defibrillation treatment were observed by LSM and SPM. High resolution observation of individual CNF fibers was realized by SPM. In the future, progress in optimizing CNF defibrillation conditions is expected to contribute to more efficient production of CNF.

#### <Acknowledgments>

We wish to express our gratitude to Assistant Professor Akihiro Hiden of the Paper Industry Innovation Center of Ehime-university (PIICE) for providing and evaluating the CNF samples and his generous guidance.

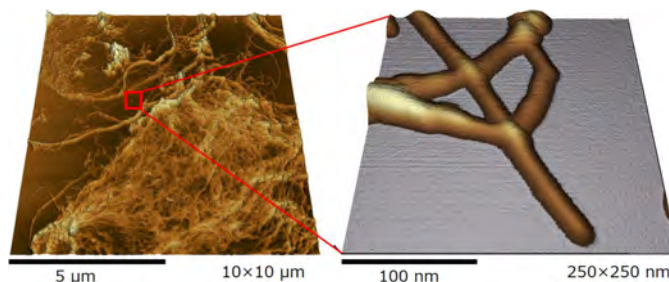


Fig. 3 High Resolution Observation of CNF After 5th Defibrillation Treatment

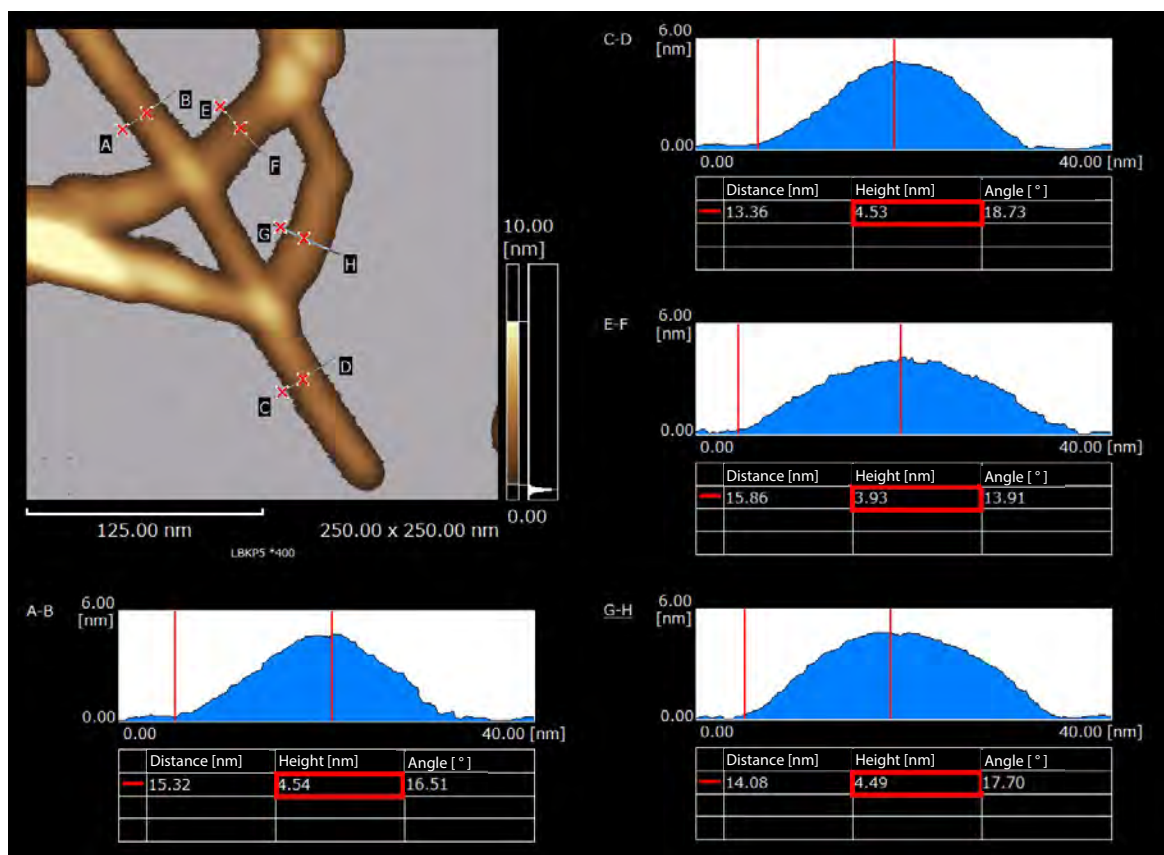


Fig. 4 Cross-Sectional Profile Analysis of Individual CNF Fiber

SPM-9700HT is a trademark of Shimadzu Corporation.

First Edition: Sep. 2018



For Research Use Only. Not for use in diagnostic procedure.

This publication may contain references to products that are not available in your country. Please contact us to check the availability of these products in your country.

The content of this publication shall not be reproduced, altered or sold for any commercial purpose without the written approval of Shimadzu. Shimadzu disclaims any proprietary interest in trademarks and trade names used in this publication other than its own. See <http://www.shimadzu.com/about/trademarks/index.html> for details.

The information contained herein is provided to you "as is" without warranty of any kind including without limitation warranties as to its accuracy or completeness. Shimadzu does not assume any responsibility or liability for any damage, whether direct or indirect, relating to the use of this publication. This publication is based upon the information available to Shimadzu on or before the date of publication, and subject to change without notice.

Shimadzu Corporation

[www.shimadzu.com/an/](http://www.shimadzu.com/an/)

# Application News

## No. A579

### Spectrophotometric Analysis

## An Evaluation of the Dispersibility and Functional Group Information of Networked CNFs and the Optical Properties of CNF Film

Cellulose is a polysaccharide that is the primary component of plant cell walls. Cellulose that is fibrillated down to the order of nanometers is called nanocellulose and of such nanocelluloses, those that have a high aspect ratio (100 or higher) with a width of 4 to 100 nm and a length of a few  $\mu\text{m}$  are called cellulose nanofibers (CNFs). CNFs are gaining attention as state-of-the-art biomass material.

There are generally two types of CNFs: monodisperse CNFs and networked CNFs. Monodisperse CNFs have a width of approx. 3 to 5 nm and each fiber is dispersed. They are therefore transparent and can easily be added functions such as water-resistance and enzymatic barriers. Networked CNFs on the other hand are larger with a width of approx. 20 to 100 nm and only require mechanical fibrillation to make. They feature easy adhesion with resins and also easy processing. Regarding monodisperse CNFs, an evaluation of dispersibility is introduced in Application News No. S31.

This article studies the dispersibility and function group information of networked CNFs. The measurement samples are CNFs (wood-derived etc.) purchased from Sugino Machine Ltd., and fermented nanocellulose (product name: Fibnano) provided by Kusano Sakko Inc., and Prof. Kenji Tajima of Hokkaido University. We also evaluated the optical properties of CNF film purchased from Sugino Machine Ltd., the results of which are also introduced in this article.

K. Sobue

### ■ Dispersibility Evaluation of a Networked CNF Solution

Four types of samples were prepared for measurement as shown in Table 1: wood-derived CNF, cellulose made from carboxymethyl cellulose and powdered chitin respectively, and fermented nanocellulose (materials: glucose, fructose). After diluting each sample to a concentration of 0.1 wt%, the linear transmission and total light transmission were measured using the conditions listed in Table 2.

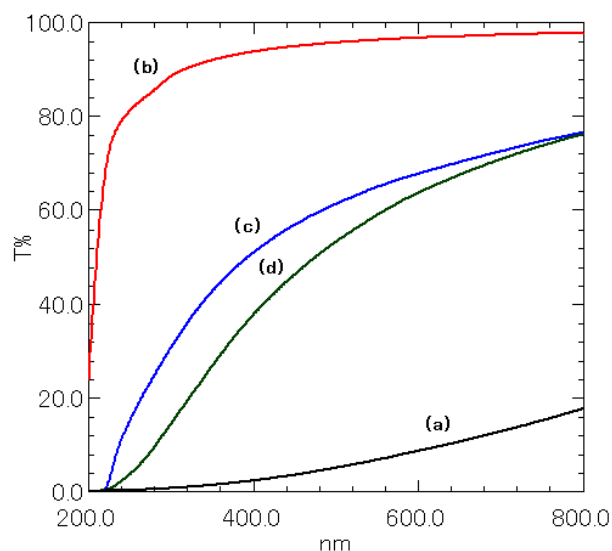
According to the linear transmission spectra shown in Fig. 1, wood-derived CNF indicates low transmission under 20 %T including the visible range. CMC exhibits high transmission exceeding 90 %T in the visible range, but drops steeply in the ultraviolet range at about 200 to 240 nm. Both chitin and fermented nanocellulose show a gradual decline in transmission from the long-wavelength range through to the short-wavelength range. All samples show a lower transmission in the linear transmission spectra compared to the total light transmission spectra (Fig. 2), suggesting that the samples are cloudy with a concentration of 0.1 wt%.

**Table 1 List of Measurement Samples**

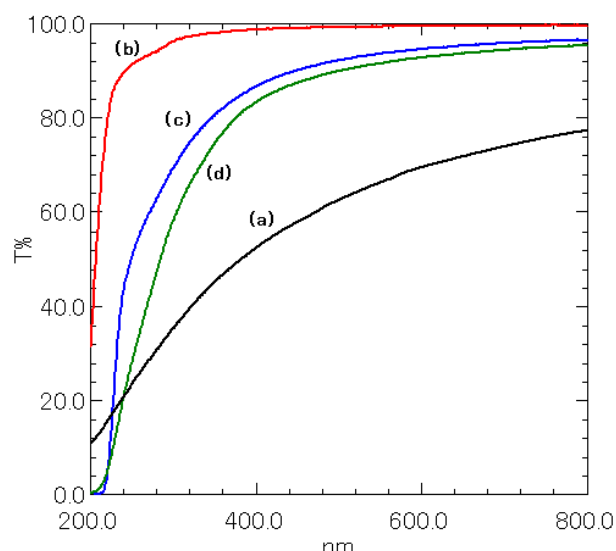
Sample Name	Material
Wood-derived CNF	Cellulose
CMC	Carboxymethyl cellulose
Chitin	Powdered chitin
Fermented nanocellulose	Glucose, fructose

**Table 2 Measurement Conditions**

Instrument Used	: UV-2600, ISR-2600 Plus
Measuring Wavelength Range	: 200 nm - 800 nm
Scan Speed	: Medium speed
Sampling Interval	: 1.0 nm
Slit Width	: 2 nm (UV-2600) 5 nm (UV-2600+ISR-2600 Plus)
Light Source Changing Wavelength	: 323 nm



**Fig. 1 Linear Transmission Spectra**  
(a) Wood-Derived CNF, (b) CMC, (c) Chitin, (d) Fermented Nanocellulose



**Fig. 2 Total Light Transmission Spectra**  
(a) Wood-Derived CNF, (b) CMC, (c) Chitin, (d) Fermented Nanocellulose

### ■ Functional Groups of Networked CNFs

Each sample in Table 1 was applied to and dried on aluminum foil as shown in Fig. 3 and then measured using the ATR method on an FTIR instrument. Table 3 lists the measurement conditions and Fig. 4 shows the measured infrared spectra.



Fig. 3 Wood-Derived CNF Applied to and Dried on Aluminum Foil

Table 3 Measurement Conditions

Instrument Used	: IRSpirit™-T (KBr window), QATR™-S (wide-band diamond prism)
Resolution	: 4 cm <sup>-1</sup>
Accumulation	: 32 times
Apodization Function	: Happ-Genzel
Detector	: DLATGS

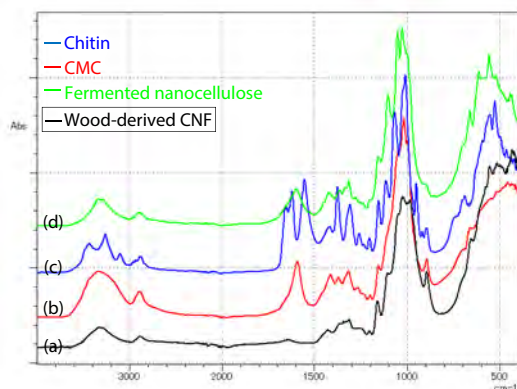


Fig. 4 Infrared Spectra

(a) Wood-Derived CNF, (b) CMC, (c) Chitin, (d) Fermented Nanocellulose

For wood-derived CNF, we can see a peak at 3600 to 3200 cm<sup>-1</sup> caused by O-H stretching vibrations and a peak at 1100 to 900 cm<sup>-1</sup> caused by C-O stretching vibrations. This matches with the cellulose included in the ATR and food additive libraries of LabSolutions™ IR. For CMC, in addition to the peaks observed for wood-derived CNF, there is a peak near 1600 cm<sup>-1</sup> caused by COO<sup>-</sup> asymmetrical stretching vibrations. Overall, the spectrum is similar to that of fermented nanocellulose. Regarding chitin, there is a peak near 3300 cm<sup>-1</sup> caused by NH stretching vibrations from amide bonds, a peak near 1650 cm<sup>-1</sup> caused by C=O stretching vibrations, and a peak near 1550 cm<sup>-1</sup> caused by NH bending vibrations and CN stretching vibrations. As described, functional groups can be determined by using FTIR.

### Optical Properties of CNF Film

The optical properties of CNF film were measured using the conditions listed in Table 2. For comparison reasons, commercially available polypropylene (PP) film and polyethylene (PE) film shown in Fig. 5 were measured as well. The measurement results are shown in Fig. 6.

The linear transmission spectra show that the transmission of CNF film is low compared to that of PP film and PE film, and that there is only about 10% of linear light transmission in the entire visible range. From the total light transmission spectra, we can see that if scattered light is included, CNF film transmits the same level of light as PP film and PE film in the visible range. Whereas PP film and PE film show a sharp drop in transmission due to the absorbance by additives in the ultraviolet range for wavelengths shorter than 250 nm, CNF film shows a gradual drop.

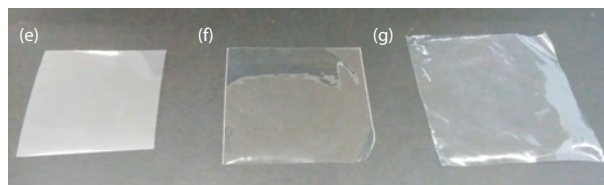


Fig. 5 (e) CNF Film, (f) PP Film, (g) PE Film

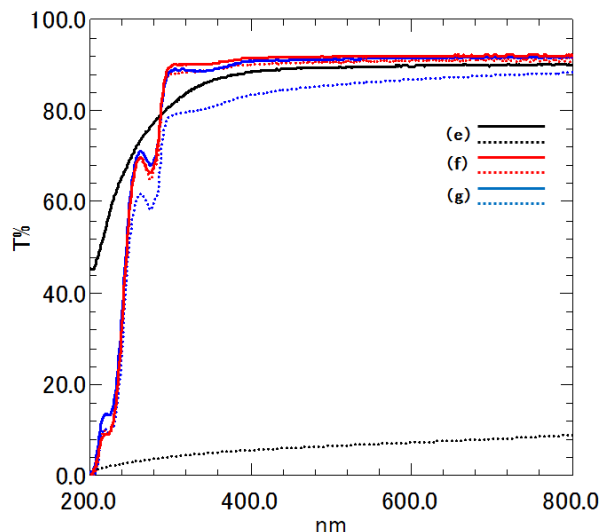


Fig. 6 Transmission Spectra  
(Solid line: Total light, Dotted line: Linear)  
(e) CNF Film, (f) PP Film, (g) PE Film

### Conclusion

In this research, we studied the dispersibility and functional group information of networked CNF samples made of differing materials. By evaluating the dispersibility of networked CNF solutions diluted to a concentration of 0.1 wt%, we determined that the CNFs are cloudy. It was also found that the transmission of each sample declines differently in the visible range and the ultraviolet range. The functional groups of each sample were easily determined by measuring dried samples using the ATR method on an FTIR. Measurements suggested that CMC and fermented nanocellulose have a similar structure. Evaluation of the optical properties of samples in film form was possible by comparing linear transmission and total light transmission. The CNF film we measured had a low linear transmission compared to PP film and PE film, but the total light transmission was at about the same level in the visible range.

### Acknowledgments

We would like to thank Tokuo Matsushima of Kusano Sakko Inc, and Prof. Kenji Tajima of Hokkaido University for providing the samples used in these measurements and their knowledge regarding CNFs.

IRSpirit, QATR, and LabSolutions are trademarks of Shimadzu Corporation.

Third-party trademarks and trade names may be used in this publication to refer to either the entities or their products/services, whether or not they are used with trademark symbol "TM" or "®".



# Application News

## No. S30

### Surface Observation

## Observation of Cellulose Nanofibers and Measurement of Fiber Length/Width

### Introduction

Cellulose is a polysaccharide consisting mainly of plant cell walls. Nanocellulose is produced by defibrating cellulose to the nanometer size. Nanocellulose with a width of 4 to 100 nm, length of approximately several  $\mu\text{m}$ , and high aspect ratio (100 or more) is called cellulose nanofiber (CNF), and is a focus of attention as an advanced new biomass material.

In addition to light weight and high strength, CNF also offers outstanding functions such as a high gas barrier property, adsorption, and transparency. Moreover, because CNF is a plant fiber-derived material, the environmental impacts associated with production and disposal are small. Application to automotive, electronic, packaging and other materials is expected in the future.

The lack of an established method for evaluating the basic physical properties of CNF is one current issue. As basic measurements, establishment of a method for measuring the fiber length and width of CNF is demanded, as they are thought to influence the mechanical strength of CNF composites. The scanning probe microscope (SPM) and electron microscope are generally used to observe nanometer-size objects, and are also widely used in observation of CNF.

This article introduces a method for observation of CNF and measurement of the fiber length/width by using Shimadzu's scanning probe microscope SPM-9700HT™.

R. Fuji

### Scanning Probe Microscope SPM-9700HT

The SPM enables high-magnification observation of the 3-dimensional shape and local properties of samples by scanning the sample surface with a microscopic probe. The appearance of the SPM-9700HT and the principle of observation are shown in Fig. 1 and 2, respectively.



Fig. 1 Scanning Probe Microscope SPM-9700HT™

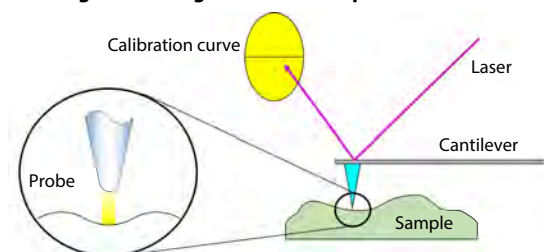


Fig. 2 Principle of SPM

### Shape Observation of CNF

The samples measured here are commercial water-dispersed cellulose products.\*1 Five types with the different fiber lengths (extra-long, long, standard, short, extra-short) shown in Fig. 3 were observed. The samples were adjusted to a concentration of 0.001 wt%, dropped on a cleaved mica surface, dried, and then observed. Fig. 4 shows the shape images of a  $10\ \mu\text{m} \times 10\ \mu\text{m}$  observation field, which makes it possible to grasp the total image. Fig. 5 shows the shape images of a  $2.5\ \mu\text{m} \times 2.5\ \mu\text{m}$  field enlarged for evaluation of the fiber length.



Fig. 3 Water-Dispersed Cellulose

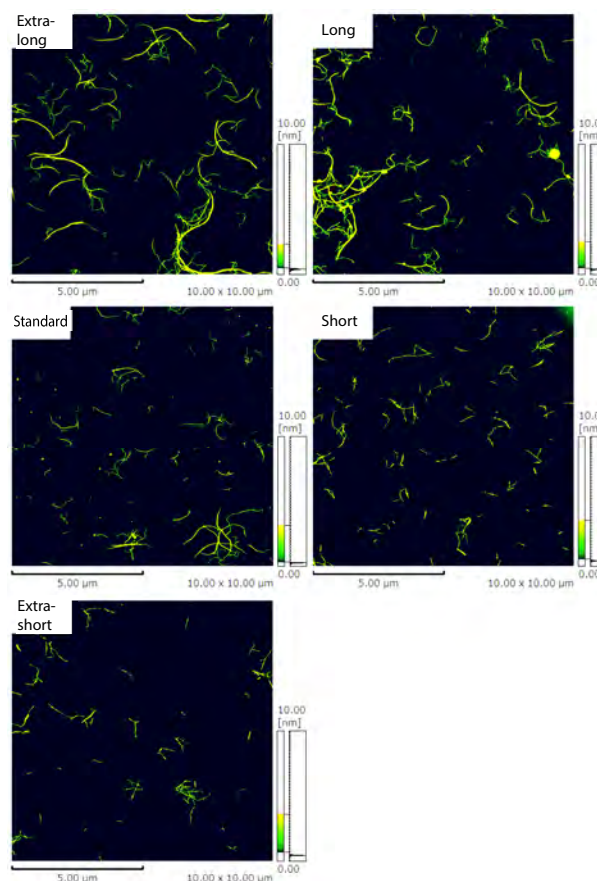


Fig. 4 Shape Images of CNF (Observation Field:  $10\ \mu\text{m} \times 10\ \mu\text{m}$ )

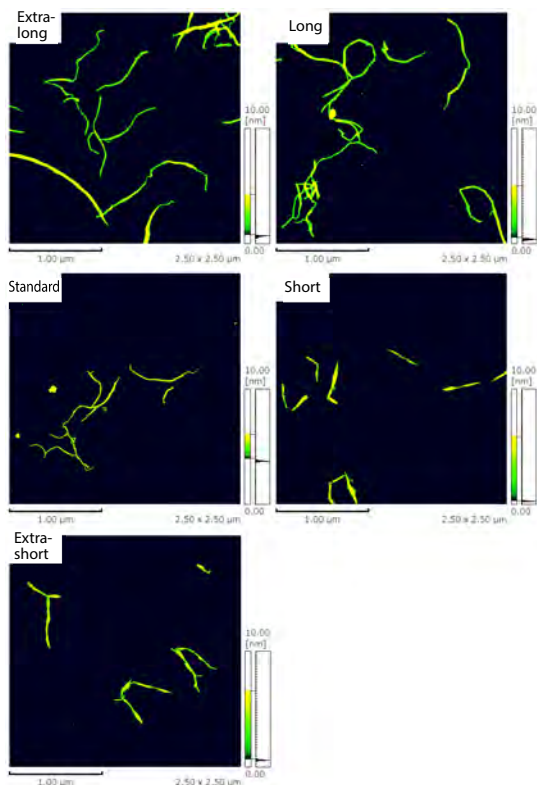


Fig. 5 Shape Images of CNF (Observation Field: 2.5 μm × 2.5 μm)

### ■ CNF Fiber Length/Width Measurement Method

Particle analysis software was used in measurements of the fiber length and width. The software first extracts the contours of the CNF as particles from the obtained 3D shape images, and then calculates the feature values of multiple extracted particles, enabling statistical analysis. The dedicated particle analysis software\*2 of SPM-9700HT supports 29 types of feature values, including length and height.

In fiber extraction, as shown in Fig. 6, a threshold is set based the height information from the obtained images, and part of the image that contains a large portion of fibers is used as the extraction object.

Because CNF has a high aspect ratio and a negligibly small width-to-length ratio, the fiber length is calculated as “circumference/2” and the fiber width is calculated as the average of Z (height) using the feature values after extraction.



Fig. 6 Particle Extraction Process of Particle Analysis Software

Fig. 7 and 8 show the measured results of “Extra-long” and “Extra-short,” respectively. The average fiber length and width of “Extra-long” were calculated as 2.2 μm (from 4.3/2) and 8 nm, and the values for “Extra-short” were calculated as 1.5 μm (2.9/2) and 11 nm. The “Extra-long” fibers included some that did not fit completely within the image, and in the case of fibers that appeared consisting of several intertwined fibers, the entire fiber was counted as one fiber. The values of fiber length and width differ greatly depending on the degree of defibration which is regarded as one fiber. Thus, clarification of the condition regarded as one fiber is an issue, particularly when measuring the fiber length.

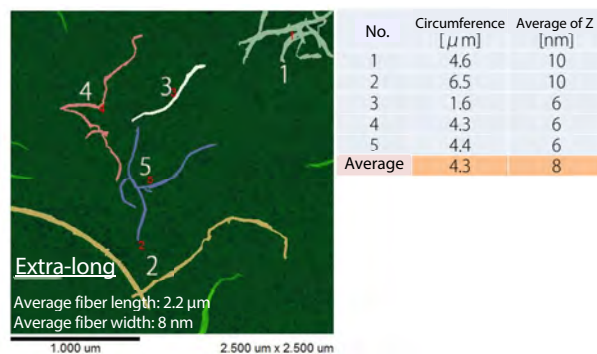


Fig. 7 Measured Results of “Extra-Long” CNF

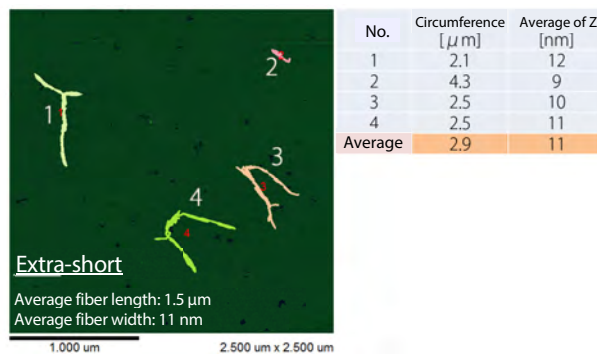


Fig. 8 Measured Results of “Extra-Short” CNF

### ■ Conclusion

Observation of CNF and measurement of the fiber length/width can be performed with an SPM with sub-nanometer resolution. Easy calculation of the fiber length/width is possible by applying particle analysis software to the 3-dimensional shape data. In the future, clarification of the definition of “one fiber” will be important for accurate measurement.

- \*1 Sugino Machine Limited, BiNFi-s® water-dispersed cellulose  
Product Nos.: IMa-10002 (Extra-long), BMa-10002 (Long), WMa-10002 (Standard), AMa-10002 (Short), FMa-10002 (Extra-short)
- \*2 C147-3093 SPM-9700HT catalog, p. 15  
Particle Analysis Software

SPM Data Room  
SPM Data Room introduces various applications of SPM.  
<https://www.shimadzu.com/an/surface/spm/dataroom.html>

Third-party trademarks and trade names may be used in this publication to refer to either the entities or their products/services, whether or not they are used with trademark symbol “TM” or “®”.

# Application News

## No. S39

### Surface Observation

## Automatic Shape Observation and Efficient Length Measurement of Fiber Length/Diameter of Cellulose Nanofibers

#### Introduction

Cellulose is a polysaccharide which is the main component of plant cell walls. Among nanocellulose obtained by defibrating cellulose to the nanometer size, fibers with a diameter of several nm to around 100 nm are called cellulose nanofiber (CNF). CNF has attracted attention as a leading-edge biomass new material. In addition to offering a combination of light weight and high strength, CNF also has other outstanding functions, such as a high gas barrier property, adsorption property, and transparency. Moreover, because CNF is derived from plant fiber, environmental loads related to production and disposal are minimal. Future applications are expected to include automotive components, electronic materials, and packaging materials, among others.

Because the fiber length and diameter of CNF are thought to influence the physical properties of CNF composites, there is a heightened need for characterization of single CNF fibers in development and manufacturing. However, improvement of characterization efficiency has become an issue, as shape observation and length/diameter measurement of several thousand individual fibers are necessary in characterization of CNF. This article introduces an example of automatic shape observation/length measurement of CNF by using a scanning probe microscope (SPM).

#### Instrument Used in Observation

The SPM enables high-magnification observation of the 3-dimensional shape and local physical properties of samples by scanning the sample surface with a microscopic probe. Fig. 1 shows the appearance of the SPM used in this experiment. Dedicated particle analysis software for the SPM-9700HT™ was used in the length measurements of the fiber length/diameter of the observed CNF.



Fig. 1 SPM-9700HT™ Scanning Probe Microscope

E. Iida

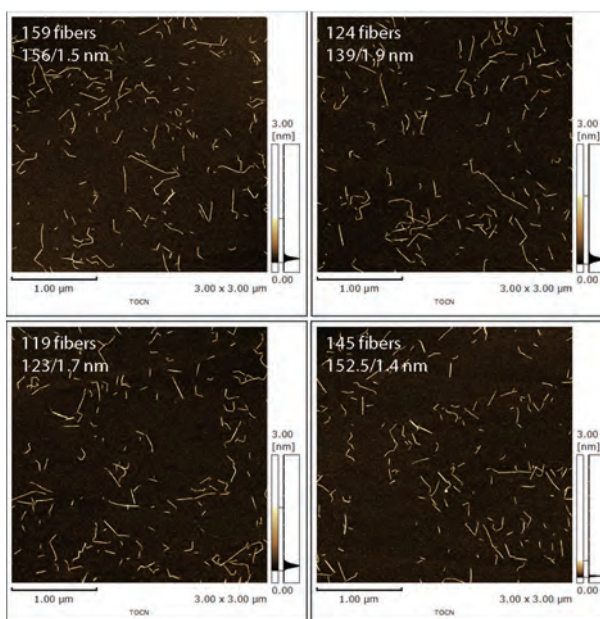


Fig. 2 Results of Automatic Shape Observation of TOCN (TEMPO-Oxidized CNF)  
(Numbers in Images: Number of TOCN and Average Fiber Length/Average Fiber Diameter)

### Automatic Shape Observation of TEMPO-Oxidized CNF

The CNF observed here was TEMPO-oxidized CNF (TOCN). TOCN is defibrated to the nanometer size by a chemical reaction called TEMPO (2,2,6,6-tetramethylpiperidine-1-oxyl)-mediated oxidation and a gentle mechanical processing. TOCN has a uniform fiber diameter of 2 to 3 nm. Since it has the features of high transparency and dispersibility in solutions, application to composite materials with resins and rubber and to paints is expected. TOCN dispersed in water was diluted to 0.001 wt% with water, dripped on a cleaved mica surface and dried, and automatic observation of 16 fields of view was carried out. In automatic observation, continuous observation of multiple fields by pushing one start button was possible by setting the observation field size, scanning speed, and offset movement amount of the observation field in advance. To prevent observation of the same fiber, a space of 3 μm was left between adjacent fields. Fig. 2 shows typical observation results. The observation field size is 3 μm × 3 μm, and the height scale is 3 nm. The individual TOCN can be seen clearly, and a condition of moderate dispersion can be observed.

### Length Measurement of Fiber Length/Diameter

Length measurement of half of the perimeter of the fibers as the fiber length and the average height of the fibers as the fiber diameter was conducted by extracting the TOCN as particles by applying the particle analysis software to each image of the 16 fields of view. For accurate length measurement, TOCN that was not completely included in an observation field of view was excluded. Fig. 3 and Fig. 4 show the results of the length

and diameter measurements, respectively. Here, 2307 TOCN could be extracted. Their average fiber length was 144.6 nm and average fiber diameter was 1.7 nm. Regarding the fiber length, approximately half of the TOCN were distributed in the range of 30 nm to 150 nm, and some TOCN with lengths of 300 nm or more were also observed. The diameters of almost all of the TOCN were distributed in the range of 1 nm to 3 nm, centering on 1.7 nm. The fiber diameter was extremely uniform, and consistency with the physical property value (2 to 3 nm) was good.

Thus, it was possible to obtain a detailed knowledge of the distributions of the fiber length and fiber diameter from the actually observed shape images.

### Conclusion

Automatic shape observation of CNF and length measurement of the fiber length/diameter were realized by using SPM. Although manual measurement of 200 to 300 CNF fibers requires several hours, about 2300 fibers could be measured in almost the same time in this experiment. Because this method is applicable not only to CNF, but also to fine particles like nanoparticles, wide application as a technique that dramatically improves efficiency in shape and particle diameter characterization is expected.

#### <Acknowledgments>

We wish to thank Prof. Akira Isogai, Associate Prof. Tsuguyuki Saito, and Research Associate Shuji Fujisawa of the University of Tokyo for providing the CNF samples and valuable guidance in the characterization.

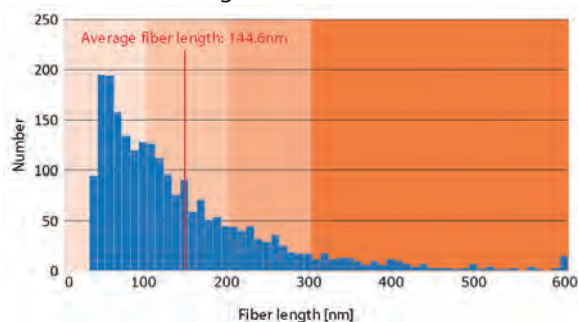


Fig. 3 Distribution of TOCN Fiber Length (Lengths over 600 nm: Shown as 600 nm)

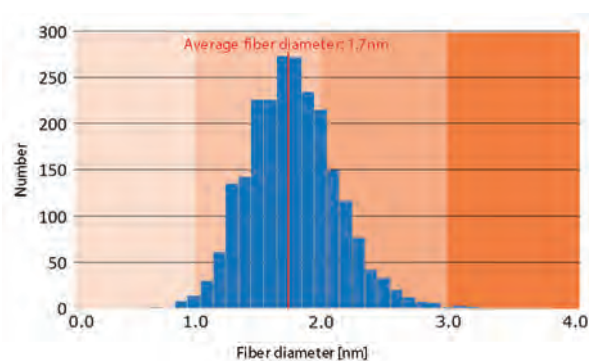


Fig. 4 Distribution of TOCN Fiber Diameter

SPM-9700HT is a trademark of Shimadzu Corporation in Japan and/or other countries.

First Edition: Jul. 2019



For Research Use Only. Not for use in diagnostic procedure.

This publication may contain references to products that are not available in your country. Please contact us to check the availability of these products in your country.

The content of this publication shall not be reproduced, altered or sold for any commercial purpose without the written approval of Shimadzu. Shimadzu disclaims any proprietary interest in trademarks and trade names used in this publication other than its own. See <http://www.shimadzu.com/about/trademarks/index.html> for details.

The information contained herein is provided to you "as is" without warranty of any kind including without limitation warranties as to its accuracy or completeness. Shimadzu does not assume any responsibility or liability for any damage, whether direct or indirect, relating to the use of this publication. This publication is based upon the information available to Shimadzu on or before the date of publication, and subject to change without notice.

Shimadzu Corporation

[www.shimadzu.com/an/](http://www.shimadzu.com/an/)

# Application News

## No. Q121

### Powder Property Analysis

## Characterization of Fiber Length and Dispersibility of Cellulose Nanofibers

Cellulose is a polysaccharide that is the main component of plant cell walls. The cellulose fibers called nanocellulose are produced by defibrating cellulose fibers. Nanocellulose fibers having a width of 4 nm to 100 nm, length of several  $\mu\text{m}$  or longer, and a high aspect ratio (100 or more) are generally called cellulose nanofibers (CNF). In addition to CNF produced from plant fibers, CNF also includes nano-fibrillated bacterial cellulose which is produced by cellulose synthesis bacteria (NFBC; also called fermented nanocellulose).

CNF is a high-performance material with a variety of desirable properties, including light weight, high strength, low thermal expansion, a high gas barrier, absorption, thickening performance, and transparency. Moreover, as a plant-derived material, CNF is also a sustainable, low environmental load resource. Future application in various fields is expected, beginning with automotive components and electronic materials. However, the lack of adequate techniques for evaluating the physical properties of CNF is an issue. The physical properties of CNF are known to be related to the fiber length and diameter, which are currently measured mainly with a microscope. Although accurate microscopic measurement is possible because the fibers are measured individually, this is a time-consuming process. Furthermore, microscopic measurements are generally carried out after drying the specimen material, and the measurement results may be different from those in the water-dispersed state. Therefore, a quick, simple method for characterization of the fiber length and dispersibility of CNF in the water-dispersed state has been desired.

This article introduces an example of characterization of the fiber length and dispersibility of various CNF by using Shimadzu's high sensitivity model SALD™-7500nano nano particle size analyzer (special specification\*, Fig. 1).

T. Sumoto

\*Please inquire concerning details.

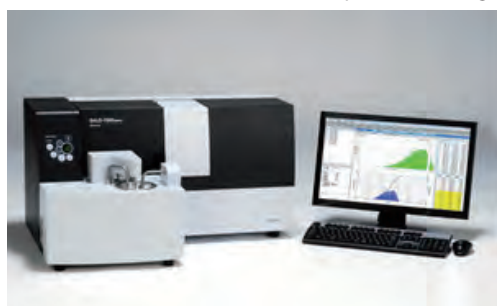


Fig. 1 High Sensitivity Model SALD™-7500nano Nano Particle Size Analyzer

### ■ Samples and Measurement Conditions

The measured samples were three types<sup>\*1</sup> of a commercially-available water dispersion-type pulp-derived CNF with different fiber lengths (ultra-long, standard, ultra-short), carboxymethylcellulose (CMC),<sup>\*1</sup> and nano-fibrillated bacterial cellulose (NFBC).<sup>\*2</sup>

The device used in the measurements was a high sensitivity model SALD-7500nano nano particle size analyzer utilizing the laser diffraction method. Fig. 2 shows the device configuration.

Due to the extremely small fiber diameter and high transparency of the samples, it is difficult to obtain scattered light from the CNF. In order to adequate scattered light, it is necessary to increase the sample concentration in comparison with ordinary samples, but when measuring fibrous samples, the fibers tend to intertwine and aggregate under high concentration conditions. For this reason, the high sensitivity model SALD-7500nano was used in these measurements.

In the measurements, the mother liquors were prepared by diluting the samples with pure water, using an MS75 sampler, and the measurements were then carried out under the conditions in Table 1. To confirm the condition of CNF dispersion, the condition with only circulation and the condition with ultrasonic irradiation (sonication) in the circulating state were compared, and changes in the dispersion condition were also checked.

\*1 Sugino Machine Limited, BiNF-i<sup>TM</sup> water dispersion-type cellulose Product No.: IMA-10002 (ultra-long), WMa-10002 (standard), FMa-10002 (ultra-short), TMA-10002 (CMC)

\*2 Kusano Sakko Inc., nano-fibrillated bacterial cellulose (NFBC; Fibnano)

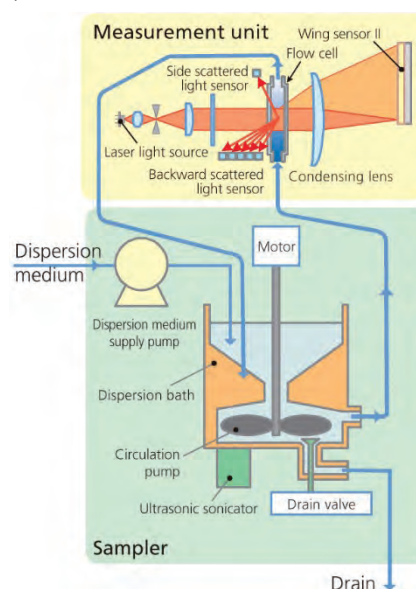
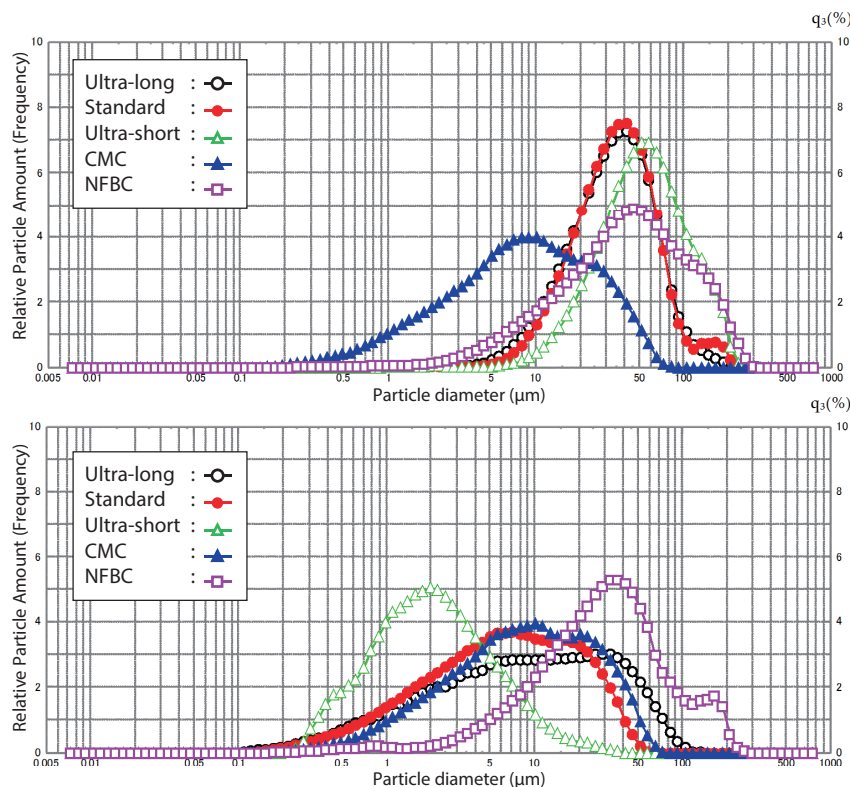


Fig. 2 Configuration of Device

Table 1 Measurement Conditions

Measurement unit	: SALD-MS75 Sampler
Dispersion medium	: Pure water
Dispersant	: None
Dispersion methods	: (1) Circulation only (2) Circulation with ultrasonic irradiation by internal sonicator
Average count	: 512
Water level	: Middle stage
Refractive index	: 1.60-1.00 i



**Fig. 3 Results of Particle Size Distribution Measurements**  
Top: Before Sonication Bottom: After Sonication

### ■ Measurement Results and Discussion

Fig. 3 shows the measurement results. The upper part of Fig. 3 shows the measurement results when the sample was simply circulated by the pump without ultrasonic irradiation by the internal sonicator of the sampler.

In the pulp-derived cellulose, the results for the samples with the different fiber lengths, i.e., ultra-long, standard, and ultra-short, showed approximately the same particle diameters for the ultra-long and standard fibers, while the diameter of the ultra-short fibers was large in comparison with the extra-long and standard fibers.

Therefore, dispersion treatment was performed by sonication with the internal sonicator of the sampler. The graph in the lower part of Fig. 3 shows the results after dispersion treatment was performed until changes in the particle diameter were eliminated by sonication.

With the pulp-derived sample, in comparison with the results before sonication, it was found that the dispersion state changed and a correlation between the fiber length and particle diameter could be obtained. This shows that accurate characterization of the fiber length is possible by performing sonication to obtain a dispersed state. The particle size of the NFBC also changed as a result of sonication, but the amount of that change was minimal. Similarly, no clear change in the particle size could be observed in the CMC before and after sonication. This is attributed to the fact that the surface of CMC molecules became negatively charged due to the carboxymethyl group introduced by chemical treatment, and this resulted in a molecular dispersion state (complete dissolution) in water.

### ■ Conclusion

Although it is possible to obtain highly accurate measurement results with current microscopic measurement techniques, measurements of the total distribution of samples require excessive time, and when samples are dried as a pretreatment process, change in the dispersion state is an issue. On the other hand, measurement in the water-dispersed state is possible by using the high sensitivity model SALD-7500nano.

From the results described here, it was found that the high sensitivity model SALD-7500nano enables simple characterization of the fiber length and dispersibility of CNF when dispersed in a liquid.

In the future, use in diverse situations, including research and development, inspections, and quality control is expected by applying the SALD-7500nano in combination with direct microscopic measurement.

#### <Acknowledgements>

In carrying out these measurements, Associate Prof. Kenji Tajima of the Polymer Functional Chemistry Laboratory, Division of Applied Chemistry, Graduate School / Faculty of Engineering, Hokkaido University and Kusano Sakko Inc. provided the nano-fibrillated bacterial cellulose (product name: Fibnano). We wish to express our deep appreciation for this assistance.

SALD is a trademark of Shimadzu Corporation in Japan and/or other countries.

Fibnano is a trademark of Kusano Sakko Inc.

BiNF-i-s is a trademark of Sugino Machine Limited.

# Application News

## No. X269

### X-Ray Analysis

## Measurement of Degree of Crystallinity of Cellulose Nanofiber

### Introduction

Cellulose is a polysaccharide, a major component of plant cell walls. Among the types of nanocellulose produced by defibrating cellulose to the nanometer size, fiber with a width of 4 nm to 100 nm, length on the order of several  $\mu\text{m}$ , and a high aspect ratio (100 or more) is called cellulose nanofiber (CNF), and has attracted considerable attention as a leading-edge biomass new material.

CNF is a lightweight, high strength material and possesses various outstanding functions such as a high gas barrier property, absorption, and transparency. Because CNF is plant-derived, it is also a low environmental impact material in production and waste disposal processes. Future applications are expected to include automotive components, electronic materials, and packaging materials.

This application news introduces an example of measurement of the degree of crystallinity of CNF by X-ray diffraction.

Y. Okamoto

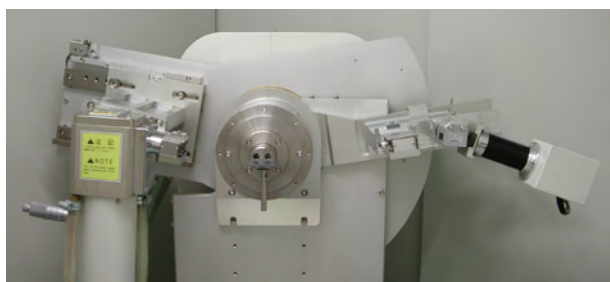


Fig. 1 XRD-7000 Goniometer

### Measurement of Degree of Crystallinity

Measurement of the degree of crystallinity is one method for evaluation of the main characteristics that influence the chemical and physical properties of cellulose. For example, strength tends to increase with the degree of crystallinity. X-ray diffraction is one technique for measurement of the degree of crystallinity.

Polymers that contain cellulose are generally divided into crystalline polymers, in which the atoms are arranged regularly, and amorphous polymers, which display low regularity. Patterns having two regions comprising crystalline and amorphous, as shown below, can be obtained by acquiring the X-ray diffraction patterns of these materials.

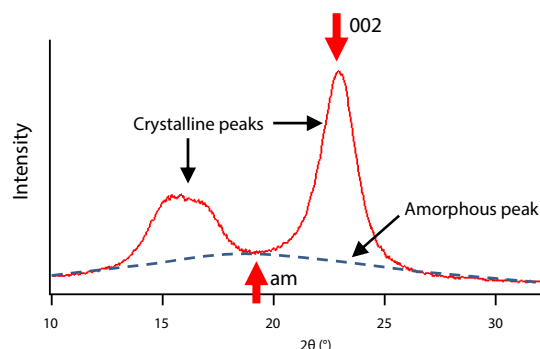


Fig. 2 Intensity Values Used in Calculation of Degree of Crystallinity of CNF

The Segal method (1959) is widely used in evaluations of cellulose crystallinity and was also used in this application news. In the Segal method, the index of crystallinity  $C_i$  (%) is obtained by the following equation by using  $I_{amr}$ , which is the intensity of the valley between the two crystalline peaks in Fig. 2 and corresponds to the height of the amorphous peak, and  $I_{002}$ , which is the height of the 002 peak.

$$C_i(\%) = \left(1 - \frac{I_{amr}}{I_{002}}\right) \times 100$$

The samples measured here were commercially-available aqueous cellulose dispersions. Five types (A, B, C, D, and E) with different fiber lengths were measured.

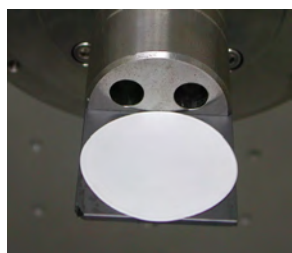
### Sample Pretreatment

In order to acquire X-ray diffraction patterns of CNF samples that can be obtained as ordinary aqueous dispersion samples, sheets were prepared by removing water in the following procedure. First, the sample material was diluted by approximately 10 times and homogenized by stirring, and was captured on a filter by suction filtration. To prevent warping of the samples, the sheets were then inserted between two plates and dried by pressurization.



Fig. 3 Aqueous Cellulose Dispersion (2 wt%)

The following Fig.4 shows an example of a sheet ( $\phi$  35 mm, 0.11 g) obtained by this pretreatment.



**Fig. 4 Cellulose Sheet ( $\phi$  35 mm, 0.11 g) on Zero Background Sample Holder**

### Measurement Conditions

The following table shows the measurement conditions. A zero background sample holder was used to enable X-ray transmission through the cellulose sheets. A Shimadzu XRD-7000 X-ray diffractometer equipped with a sample horizontal goniometer was used in the measurements.

**Table 1 Measurement Conditions**

Instrument	XRD-7000 X-ray diffractometer
X-ray target	Cu
Tube voltage-tube current	40 kV-40 mA
Monochromatization	Counter monochromator
Measurement range	2 $\theta$ : 10-32.5°
Scanning speed	2°/min
Detector	Scintillation detector
Measurement mode	Continuous scan
Sample holder	Zero background sample holder

### Measurement Results

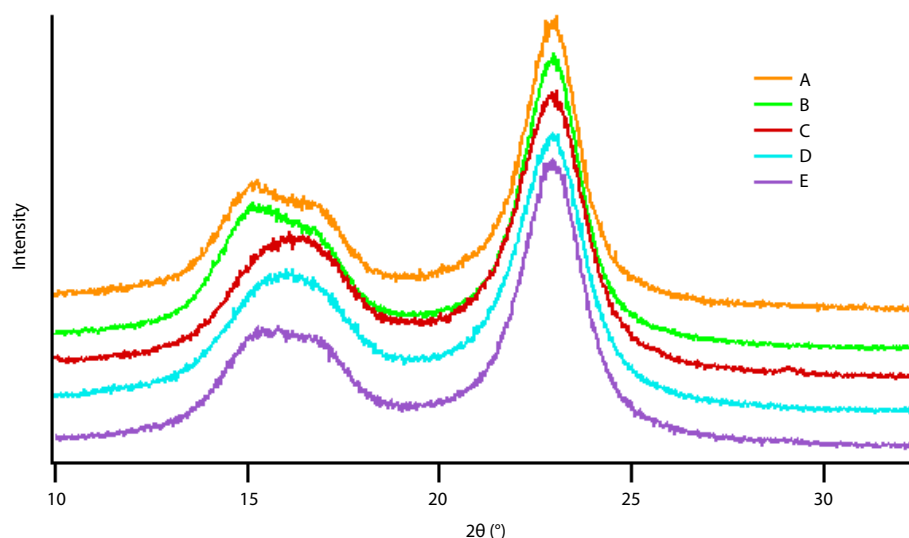
Fig. 5 shows the measured patterns of the five types. Table 2 shows the results of calculation of the degree of crystallinity by the Segal equation. Differences could be seen in the degree of crystallinity by sample type.

**Table 2 Results of Degree of Crystallinity**

Sample	$C_i$ (%)
A	84
B	86
C	76
D	77
E	82

### Conclusion

It was possible to evaluate the degree of crystallinity of CNF by X-ray diffraction. Application of this technique to quality control of parts and materials is expected.



**Fig. 5 Measured Patterns (Intensity Normalized by 002 Plane Peak)**

First Edition: Dec. 2018



**For Research Use Only. Not for use in diagnostic procedure.**

This publication may contain references to products that are not available in your country. Please contact us to check the availability of these products in your country.

The content of this publication shall not be reproduced, altered or sold for any commercial purpose without the written approval of Shimadzu. Shimadzu disclaims any proprietary interest in trademarks and trade names used in this publication other than its own. See <http://www.shimadzu.com/about/trademarks/index.html> for details.

The information contained herein is provided to you "as is" without warranty of any kind including without limitation warranties as to its accuracy or completeness. Shimadzu does not assume any responsibility or liability for any damage, whether direct or indirect, relating to the use of this publication. This publication is based upon the information available to Shimadzu on or before the date of publication, and subject to change without notice.

Shimadzu Corporation

[www.shimadzu.com/an/](http://www.shimadzu.com/an/)



# Application News

## No. S31

### Surface Observation

## Evaluation of Fiber Length and Dispersibility of Mono-Dispersed Cellulose Nanofibers

### Introduction

Cellulose is a polysaccharide consisting mainly of plant cell walls. Nanocellulose is produced by defibrating cellulose to the nanometer size. Nanocellulose with a width of 4 to 100 nm, length of approximately several  $\mu\text{m}$ , and high aspect ratio (100 min.) is called cellulose nanofiber (CNF), and is a focus of attention as an advanced new biomass material.

In addition to light weight and high strength, CNF also offers outstanding functions such as a high gas barrier property, adsorption, and transparency. Moreover, because CNF is a plant fiber-derived material, the environmental impacts associated with production and disposal are small. Application to automotive, electronic, packaging and other materials is expected in the future.

The lack of an established method for evaluating the basic physical properties of CNF is one current issue. As basic measurements, establishment of a method for measuring the fiber length and width of CNF is demanded, as they are thought to influence the mechanical strength of CNF composites. Application News No. S30<sup>1)</sup> introduced a method for measuring the fiber length/width by using a scanning probe microscope (SPM).

This research examined the use of a particle size analyzer and UV-visible spectrophotometer in addition to SPM.

The particle size analyzer is used to evaluate a large quantity of fibers rapidly, for example, in quality control applications, and the UV-visible spectrophotometer is used to evaluate the correlation between fiber length and dispersibility with the aim of enhancing the dispersibility of CNF in the matrix.

The following introduces evaluation of fiber length by using the Shimadzu single nano particle size analyzer IG-1000 Plus and scanning probe microscope SPM-9700HT<sup>TM</sup>, and evaluation of dispersibility by using the UV-visible spectrophotometer UV-2600. Fig. 1 shows these instruments.

R. Fujii, K. Sobue, T. Sumoto



**Fig. 1 Single Nano Particle Size Analyzer IG-1000 Plus (Upper Left), Scanning Probe Microscope SPM-9700HT<sup>TM</sup> (Upper Right), and UV-visible spectrophotometer UV-2600 (Bottom)**

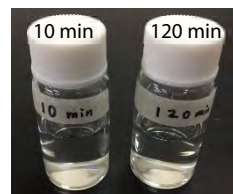
### Mono-Dispersed TEMPO-Oxidized CNF

CNF consisting of completely disaggregated fibers kept in a solution in a dispersed, aggregation-free condition is called the mono-dispersed type. The material evaluated here was mono-dispersed TEMPO-oxidized CNF, which was disaggregated to the nanometer size by a combination of a TEMPO-catalyzed oxidation reaction (TEMPO: 2,2,6,6-tetramethylpiperidine-1-oxyl) and slight mechanical treatment. TEMPO-oxidized CNF has a homogeneous fiber width of 3 nm to 4 nm and high dispersibility and transparency in solutions, and is expected to find wide industrial application in paints and composites with resin and rubber.

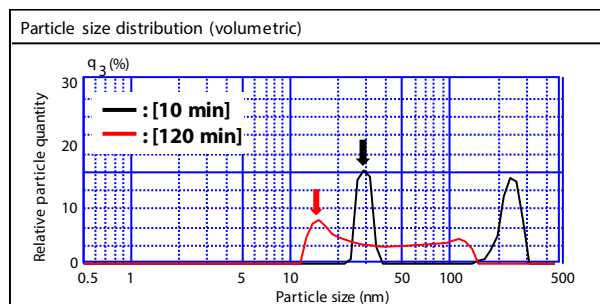
### Evaluation of Fiber Length by Induced Grating Method

Fig. 2 shows TEMPO-oxidized CNF solutions after mechanical treatment for 10 min and 120 min. These samples were adjusted to a concentration of 0.1 wt% and measured with the IG-1000 Plus.

In the induced grating (IG) method, a diffraction grating consisting of particle groups is created in a solution by applying an AC voltage to regularly-arranged electrodes, and then disintegrates and disperses when the AC voltage is discontinued. Large particles disperse slowly, while smaller particles disperse rapidly. This diffusion process is detected as a change in the intensity of diffracted light and is output as peaks showing the particle size distribution. The results of measurement of the particle size distribution are shown in Fig. 3.



**Fig. 2 TEMPO-Oxidized CNF**



**Fig. 3 Results of Measurement of Particle Size Distribution**

With the sample treated for 10 min, peaks were detected at 30 nm and 250 nm, whereas a broad peak extending from 10 nm to 150 nm was observed with the 120 min sample. As shown by the arrows in Fig. 3, the largest relative particle quantity was around 30 nm with the 10 min sample and around 15 nm with the 120 min sample, indicating that the particle size decreases as the mechanical treatment time is extended. However, there is a possibility that IG may detect not only the fiber length, but also averaged information for the fiber length and fiber width as the particle diameter.

Therefore, in order to verify that the results of the IG measurements were in fact the measured fiber length, samples were observed with a nanometer-level resolution SPM.

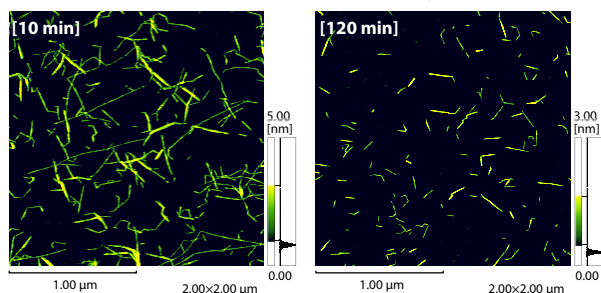
### Evaluation of Fiber Length by SPM

TEMPO-oxidized CNF solutions treated mechanically for 10 min and 120 min were adjusted to a concentration of 0.001 wt%, dripped on cleaved mica and dried, and observed with the SPM-9700HT.

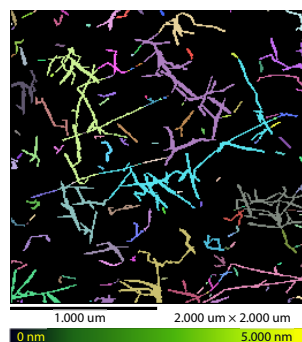
Particle analysis software was used in measurements of the fiber length/width. The software first extracts the contours of the CNF from the obtained 3D shape image as particles, and then calculates the feature values of multiple extracted particles, enabling statistical analysis. The dedicated particle analysis software<sup>2)</sup> of the SPM-9700HT supports 29 types of feature values, including length and height.

Because CNF has a high aspect ratio and its width-to-length ratio is negligibly small, the fiber length was calculated as "circumference/2" using the feature values after extraction.

Fig. 4 shows the shape images, and Fig. 5(a) and (b) show the images of the extraction process and the measurement results for the 10 min sample and 120 min sample, respectively.

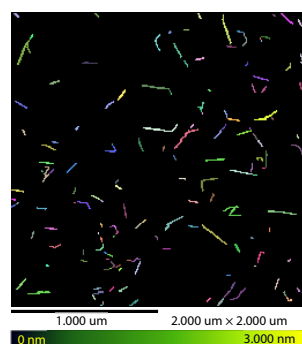


**Fig. 4 Shape Images of CNF**  
Left: 10 min, right: 120 min (observation field: 2 μm × 2 μm)



Number of extracted fibers	152
Average circumference	400 nm
Average fiber length (Average circumference/2)	200 nm

**Fig. 5 (a) Image of Extraction Process and Measurement Results of 10 Min Sample**



Number of extracted fibers	157
Average circumference	100 nm
Average fiber length (Average circumference/2)	50 nm

**Fig. 6 (b) Image of Extraction Process and Measurement Results of 120 Min Sample**

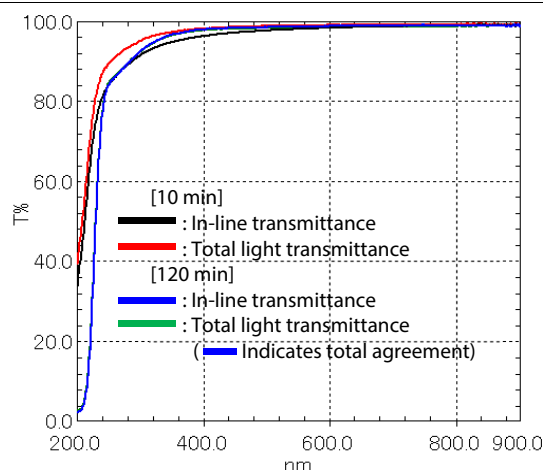
The average fiber lengths of the 10 min and 120 min samples were calculated as 200 nm and 50 nm, respectively. Thus, these SPM results showed partial agreement with the IG results, in which peaks were detected at 30 nm and 250 nm with the 10 min sample and in the range of 10-150 nm with the 120 min sample. This suggests that the fiber length can be evaluated by IG. The fact that the IG results showed peaks in a range that did not coincide with the SPM results presumably occurred because the IG results also contained averaged information for the fiber length and width.

### Evaluation of Dispersibility by UV

To evaluate the dispersibility of CNF in solutions, in-line transmittance was measured with the UV-2600 and total light transmittance was measured by using an integrating sphere as an attachment. In in-line transmittance measurement, only the light that passes straight through the sample is measured, whereas in total transmittance measurement, all the light that passes through the sample is measured, including scattered light. It can be presumed that the sample is transparent if the results of the two methods are the same, and the sample is cloudy if the results are different. The measurement conditions and results are shown in Table 1 and Fig. 6, respectively.

**Table 1 Measurement conditions of UV-2600**

Attachment	: Integrating sphere ISR-2600 Plus
Wavelength range	: 200 nm to 900 nm
Scan speed	: Medium
Sampling pitch	: 1.0 nm
Photometric value	: Transmittance
Slit width	: 2 nm (UV-2600) 5 nm (UV-2600 + ISR-2600 Plus)
Light source switching wavelength	: 323 nm



**Fig. 7 Measurement Results**

With the 10 min sample, the transmittance of the UV region (200-400 nm) was higher in the total light transmittance measurement than in the in-line transmittance measurement. From this, it can be inferred that light was scattered as a result of partial aggregation of CNF in solutions. On the other hand, with the 120 min sample, the two transmittance values coincided perfectly, indicating that virtually no CNF aggregation occurred and the dispersibility of the CNF was high.

### Conclusion

This study showed that IG enables direct measurement of CNF in solutions, and the results of IG measurements display a good correlation with the results of measurements of the fiber length by SPM. Use of IG as a faster method for evaluating large quantities of fibers can be expected. In particle size analyzers, IG with a measurement range of 0.5 nm to 200 nm is suitable for measurements of mono-dispersed CNF, which have a comparatively short fiber length and high dispersibility in solutions. In the future, it will be necessary to study sample materials other than TEMPO-oxidized CNF.

The dispersibility of CNF could be evaluated by in-line transmittance and total light transmittance by UV. The sample that was mechanically processed for 120 min had a shorter fiber length and showed less aggregation and higher dispersibility than the sample processed for 10 min.

#### <Acknowledgement>

The authors wish to express their deep appreciation to Prof. Akira Isogai of the Dept. of Biomaterial Sciences, Graduate School of Agricultural and Life Sciences, The University of Tokyo for providing the TEMPO-oxidized CNF samples and fruitful discussion.

#### Reference

- (1) Application News No. S30, Observation of Cellulose Nanofibers and Measurement of Fiber Length/Width.

# Application News

## No. S37

### Surface Observation

## Observation and Characterization of Dispersion State of Cellulose Nanofibers and Polymer Composite

### Introduction

Cellulose is a polysaccharide, which is a main component of plant cell walls. Among nanocellulose materials produced by defibrating cellulose to the nanometer size, those with a width of 4 to 100 nm, length on the order of several  $\mu\text{m}$ , and high aspect ratio (100 or higher) are called cellulose nanofibers (CNF), and have attracted attention as a leading-edge new biomass material. Because CNF has a variety of outstanding functions, including a high gas barrier property, absorption, and transparency, in addition to light weight and high strength, composites of CNF with polymer materials are expected to display improved physical properties.

Although characterization of the dispersion states of CNF and polymer composite in the material is important in the development of composite materials, the current characterization techniques cannot be considered adequate.

This report introduces an example of a CNF composite material and characterization of its dispersion state by using a Shimadzu scanning probe microscope (SPM) and Nano Search microscope (SFT).

E. Iida

### Observation Instruments

SPM applies a technique in which the surface of a sample material is scanned with a microscopic probe, enabling high-magnification observation of the 3-dimensional topography and local physical properties of the sample. Nanophysics Evaluation System "Nano 3D Mapping™" was used in characterization of the dispersion state. SFT is a hybrid instrument consisting of a laser scanning microscope (LSM) and SPM, and makes it possible to observe the 3-dimensional topographies of sample materials over a wide range of magnifications. Fig. 1 shows the appearance of these instruments.



Fig. 1 Nano Search Microscope SFT-4500 (Left), Scanning Probe Microscope SPM-9700HT™ (Right)

### Wide-Range Observation of CNF/PVP Composite Material

The sample material was prepared by mixing a CNF aqueous solution (1 wt%) and a polyvinyl pyrrolidone (PVP) aqueous solution (30 wt%) at a ratio of 1 : 2 and injecting the mixed solution onto a Si substrate by the electrospinning method. Fig. 2 shows the results of observation with the SFT. In the LSM observations in (a) to (c), a condition of complex intertwining of the fibers can be observed. When the area shown by the yellow square at the center of (c) is observed with the SPM, the fine shape of the fibers can be seen from the height image (d). In the phase image (e) of the same view as (d), the difference in the physical properties of the CNF and PVP can be seen. They are represented by the different colors of the yellow region and brown region (e.g., part indicated by the red arrow). Looking at the overlaid image (f) of images (d) and (e), the fact that the outermost surfaces of the fibers are not uniform can be understood from the distribution of the yellow and brown regions on the fibers.

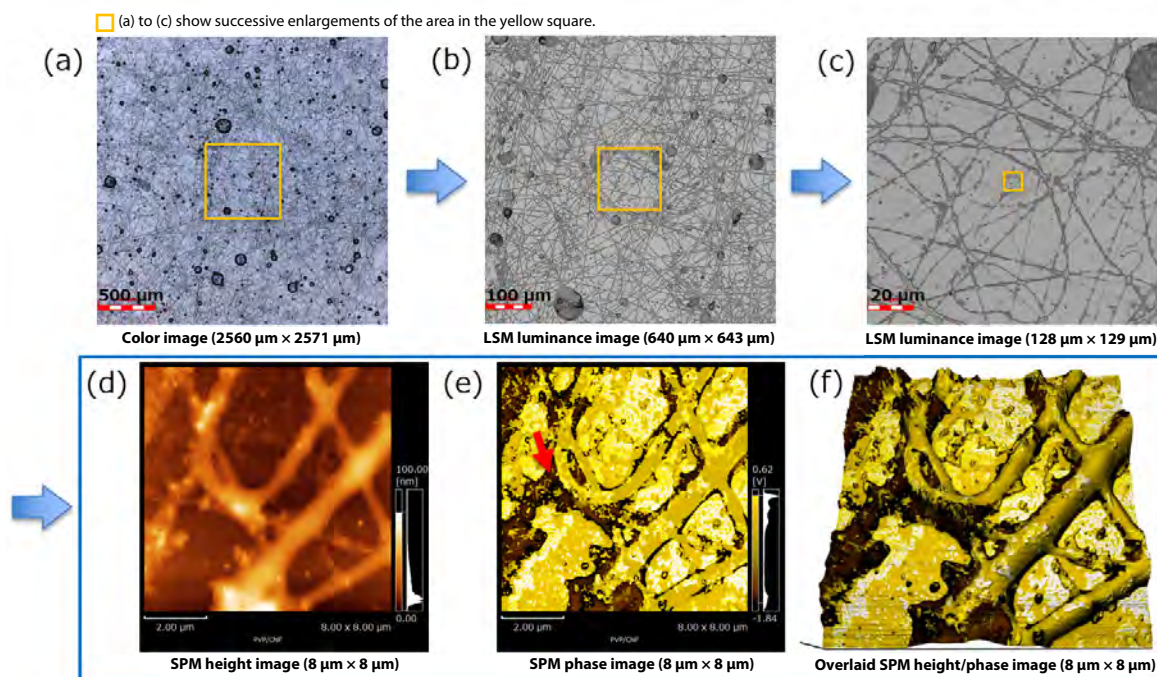


Fig. 2 SFT Images of CNF/PVP Composite

### 3D Mapping of Young's Modulus of Composite and Single Materials

3D mapping of the Young's modulus of the CNF/PVP composite material and the PVP single material was performed with the SPM. Fig.3 shows images of the Young's modulus images overlaid on the 3D topographic images. The number of data points of both (a) CNF/PVP composite and (b) PVP single material is 128 × 128. The numbers attached to the images correspond to the numbers of the measurement points in the table at the right.

The positional relationship between the fibers and the distribution of Young's modulus can be seen clearly in (a). There are regions showing Young's modulus of approximately 100 MPa (light blue) and regions showing approximately 300 MPa (yellow). From (b), the Young's modulus of the single PVP is around 100 MPa. Therefore, the regions shown by 1 to 5 in (a) are considered to be areas where PVP exists on the outermost surface, while the regions shown by 6 to 10 are areas where CNF exists on the outermost surface.

As demonstrated here, visualization of the dispersion state of CNF and PVP was possible by using Nano 3D Mapping.

### Conclusion

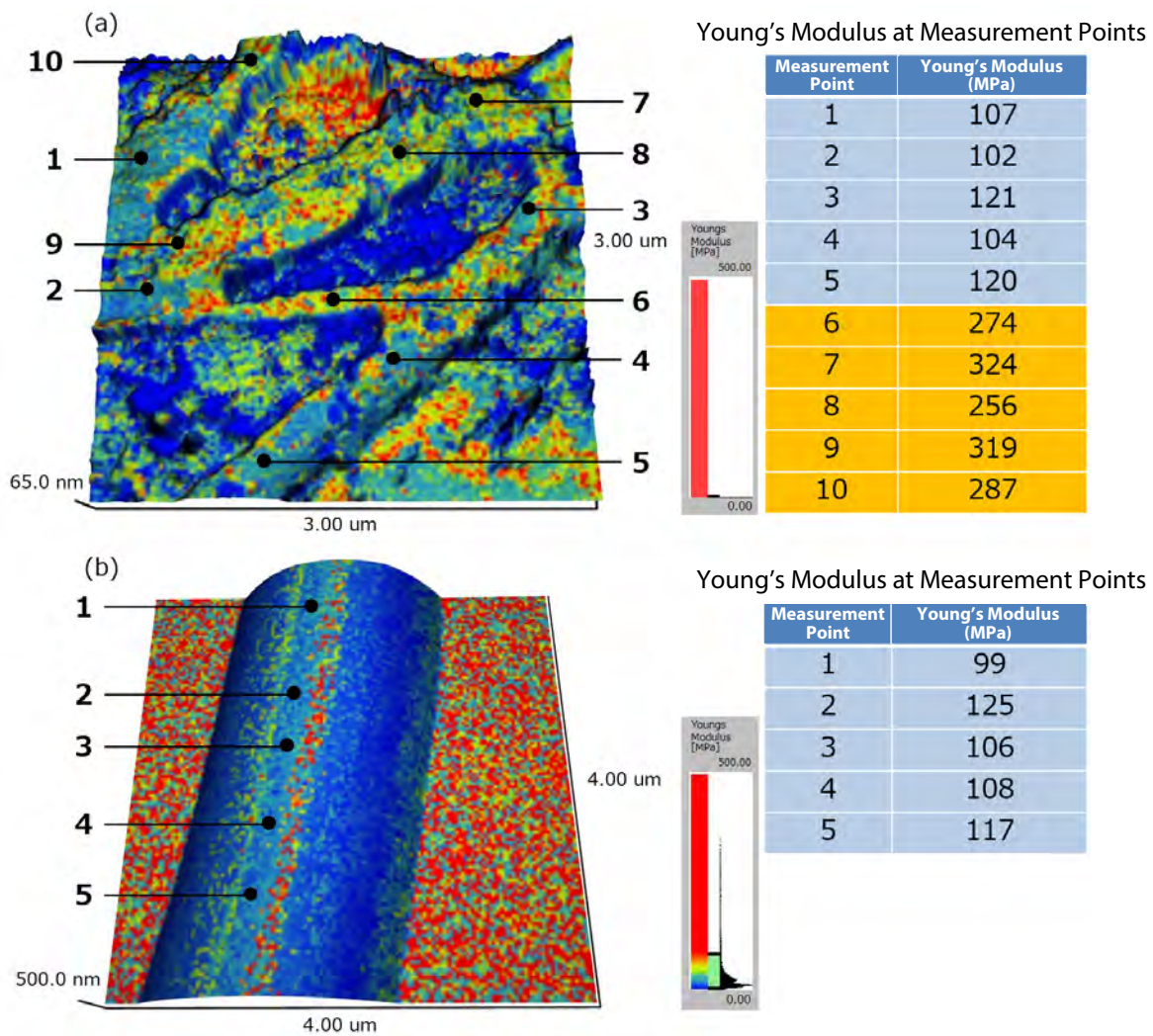
A wide range of information was obtained by SFT observation, from the overall shape of the fibers to their microtopography, and the distribution originating from differences in the physical properties of the CNF and PVP was also visualized. It was possible to characterize the dispersion states of CNF and PVP by mapping of the Young's modulus by SPM.

In the future, application of this technique to various composite materials containing CNF and polymers is expected.

#### <Acknowledgments>

The sample materials used here were provided by Prof. Takahisa Nakai of Mie University and Researcher Keisuke Toba of the Forest Research and Management Organization.

SPM-9700HT and Nano 3D Mapping are trademarks of Shimadzu Corporation in Japan and/or other countries.



**Fig. 3 3D Mapping of Young's Modulus**  
(a) CNF/PVP Composite, (b) PVP Single Material

First Edition: Mar. 2019



For Research Use Only. Not for use in diagnostic procedure.

This publication may contain references to products that are not available in your country. Please contact us to check the availability of these products in your country.

The content of this publication shall not be reproduced, altered or sold for any commercial purpose without the written approval of Shimadzu. Shimadzu disclaims any proprietary interest in trademarks and trade names used in this publication other than its own. See <http://www.shimadzu.com/about/trademarks/index.html> for details.

The information contained herein is provided to you "as is" without warranty of any kind including without limitation warranties as to its accuracy or completeness. Shimadzu does not assume any responsibility or liability for any damage, whether direct or indirect, relating to the use of this publication. This publication is based upon the information available to Shimadzu on or before the date of publication, and subject to change without notice.

Shimadzu Corporation

[www.shimadzu.com/an/](http://www.shimadzu.com/an/)

# Application News

## No. i264

### Constant Test Force Extrusion Type Capillary Rheometer Flowtester

## Viscosity Evaluation of Cellulose Nanofiber-Reinforced Composite

Cellulose is the main component of the cell walls of plant cells, cotton, and other materials. It is the most abundant carbohydrate on Earth and has a long history of use as a raw material for paper and textiles. Cellulose nanofiber (hereinafter, CNF) with higher functionality realized by defibrating cellulose to the nano level has been focused in recent years. As a plant-derived material, CNF has a low environmental impact, and also has various desirable functions including low linear expansion, a gas barrier property, and transparency. It is lightweight, weighing only 1/5 as much as steel, and displays high specific strength, being 5 to 8 times stronger than ferrous materials. Therefore, research aimed at developing high strength, lightweight composite materials by strengthening thermoplastic resins with CNF is progressing.

One of the features of thermoplastic resins is good productivity. Many mass-produced molded resin products are molded by melting the resin by techniques such as injection molding or extrusion molding. For example, in injection molding, the proper temperature and pressure differ depending on the type of resin, the mold shape, and other factors. Poor conditions can cause molding defects including short shot (underfilling), overcharge, sink mark, and voids. Moreover, even if molding is performed under the proper conditions, changes in the condition of the raw material resin can lead to molding defects. Thus, it is essential to determine the optimum molding conditions for CNF-reinforced composite materials.

As one technique for evaluating these moldability properties of thermoplastic resins, in this study, fluidity was evaluated by using a Shimadzu CFT-EX flowtester. Fig. 1 shows the measuring instrument. Three types of measurement samples, i.e., CNF-reinforced composite, glass fiber (GF)-reinforced plastics, and a simple resin without reinforcement, were used.

F. Yano



Fig. 1 CFT-EX Flowtester

### Measurement System

Fig. 2 shows the structure of the cylinder part of the CFT-EX used here. In the CFT-EX, the cylinder is filled with the sample material, which is melted by heat from the surrounding part, and constant pressure is applied from the top by a piston. The molten material is extruded through a die with a small-diameter hole. The flowrate is obtained from the piston speed at this time, and the fluidity, i.e., the melt viscosity of the sample material is calculated. For details, please refer to Shimadzu catalog (CFT-EX Series) <sup>(1)</sup>.

The weight of the pellet sample used in one measurement was 1.5 g. Measurements were conducted at test temperatures of 170, 190, and 210 °C and 5 test pressure levels in the range from 0.49 MPa to 9.8 MPa. The sample information and measurement conditions are shown in Table 1 and 2, respectively.

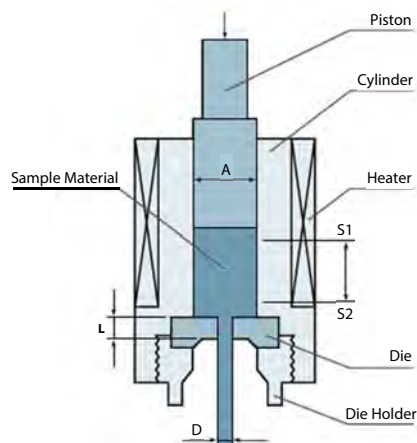


Fig. 2 Structure of Cylinder Part

Table 1 Measurement Sample Information

Measurement Samples	
(1)	CNF 10 % reinforced HDPE (pellet)
(2)	GF 10 % reinforced HDPE (pellet) *1
(3)	HDPE (pellet)

Sample material provided by Kyoto Municipal Institute of Industrial Technology and Culture.

\*1 Material (2) was prepared as a comparison sample for research and development.

Table 2 Measurement Conditions

Instrument	: CFT-500EX
Test temperature	: 170, 190, 210 °C
Test pressure	: 0.49, 0.98, 1.96, 4.9, 9.8 MPa
Preheating time	: 360 s
Die	: Diameter 1 mm, length 1 mm

### Measurement Results

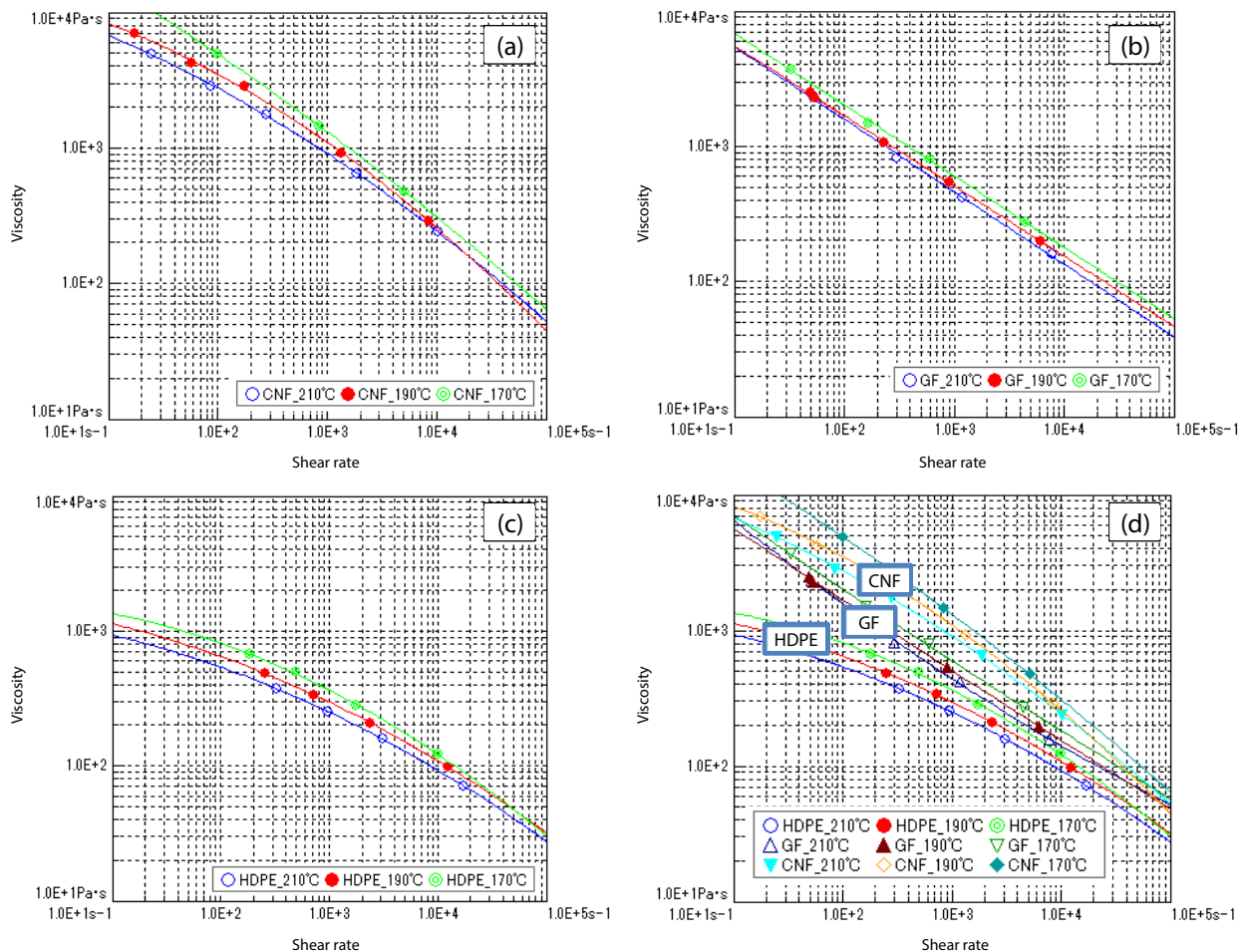
Fig. 3 (a) to (c) show the measurement results of each material, and (d) shows the measurement results for all materials. In Fig. 3, the abscissa shows the shear rate and the ordinate shows viscosity. From Fig. 3 (a) to (c), the viscosities of all materials tended to decrease as the measurement temperature increased. Similarly, a condition in which the viscosity decreased as the shear rate became larger was also confirmed. From Fig. 3 (d), if the viscosities of the respective materials are compared, the unreinforced HDPE displayed the lowest viscosity, the GF-reinforced HDPE showed the next highest viscosity, and the CNF-reinforced HDPE showed the highest viscosity. This means viscosity is increased by adding reinforcing material. Comparing the CNF-reinforced HDPE and the GF-reinforced HDPE, at the shear rate of  $1.0 \times 10^5/s$ , the viscosity of the CNF-reinforced HDPE approaches the viscosity value of approximately 50 Pa·s of the GF-reinforced HDPE. This phenomenon agrees with the feature that the viscosity of CNF-reinforced composite decreases under high shear rates<sup>(2)</sup>, and is also consistent with the fact that, in actual high-speed molding processes such as injection molding, molding is possible to a certain extent even when using molding machine dies for GFRP. Viscosity was calculated in the piston stroke range of 3 mm to 7 mm in accordance with JIS K 7210-1 (Annex JA).

### Conclusion

Viscosity-shear rate curves different from that of a simple thermoplastic resin were obtained by adding CNF or GF to the resin. Viscosity evaluation of the respective materials is an important measurement for obtaining the optimum molding conditions. The CFT-500EX used in this study is a suitable instrument for fluidity evaluations of CNF-reinforced composites.

#### References

- (1) Shimadzu Corporation catalog, CFT-EX Series C228-4592.
- (2) Akihiro Ito, Nanocellulose Symposium 2018, Abstracts of 365<sup>th</sup> Symposium on Sustainable Humanosphere, 47 (2018).



**Fig. 3 Measurement Results**  
(a) CNF-Reinforced HDPE (b) GF-Reinforced HDPE (c) HDPE (d) All Measurement Results

First Edition: Jan. 2019



For Research Use Only. Not for use in diagnostic procedure.

This publication may contain references to products that are not available in your country. Please contact us to check the availability of these products in your country.

The content of this publication shall not be reproduced, altered or sold for any commercial purpose without the written approval of Shimadzu. Shimadzu disclaims any proprietary interest in trademarks and trade names used in this publication other than its own. See <http://www.shimadzu.com/about/trademarks/index.html> for details.

The information contained herein is provided to you "as is" without warranty of any kind including without limitation warranties as to its accuracy or completeness. Shimadzu does not assume any responsibility or liability for any damage, whether direct or indirect, relating to the use of this publication. This publication is based upon the information available to Shimadzu on or before the date of publication, and subject to change without notice.

Shimadzu Corporation

[www.shimadzu.com/an/](http://www.shimadzu.com/an/)

# Application News

## No. i265

### Material Testing Machine

## 3-Point Flexural Test of Cellulose Nanofibers Reinforced Plastics

### ■ Introduction

Plastic foam is lightweight and has excellent thermal insulating and shock-absorbing properties because the interior of the material contains numerous voids. On the other hand, the strength of plastic foam is lower than that of non-foam materials, as the volume of plastics per unit volume is smaller. Addition of fiber or other reinforcing materials is one technique for obtaining satisfactory strength in materials in which foaming is used to impart light weight and thermal insulating properties. Although glass fiber and carbon fiber are often used as reinforcing materials, research and development using cellulose nanofibers (hereinafter, CNF) as a plant-derived high performance new material has progressed recently.

Cellulose, consisting mainly of substances such as plant cell walls and cotton, is the most common carbohydrate on Earth and has long been used as a raw material for paper and cotton fiber. Recently, CNF with higher functionality realized by defibrating cellulose to the nano level has attracted interest. As a plant-derived material, CNF has a low environmental impact, and also has a variety of desirable properties, including low linear expansion, a gas barrier property, and transparency. In comparison with ferrous materials, CNF weighs only 1/5 as much but has a high specific strength, being 5 times stronger than steel, and strength equal or superior to that of the conventional materials can be realized compounding CNF with plastics and rubber. Therefore, CNF has attracted interest as a new material following carbon fiber.

This article introduces a 3-point flexural test using a deflection measuring device and test speed in compliance with JIS K 7171, which is generally used in strength evaluation of plastics, and compares the differences in flexural strength with/without CNF and with/without foaming.

Y. Kamei

### ■ Specimens

The CNF reinforced plastic measured in the study was a high density polyethylene (hereinafter, HDPE). Test specimens\*1 were prepared by adding 5% CNF to HDPE as the matrix plastic. To investigate differences in the internal condition, internal observation of the specimens was performed with an inspeXio SMX-100CT microfocus X-ray CT system prior to the tests. Fig. 1 shows CT images of the specimens, in which voids appear as black areas. There is no large difference between the non-foamed plastic without CNF (①) and the non-foamed CNF reinforced plastic (②). In the foamed plastics, it was found that finer voids existed in a uniformly dispersed condition in the CNF reinforced plastic (④) than in the plastic without CNF. Thus, the possibility that CNF impedes the growth and coalescence of voids is conceivable.

\*1 Specimens provided by Kyoto Municipal Institute of Industrial Technology and Culture, a Local Incorporated Administrative Agency.

### ■ Measuring System

Fig. 2 shows the condition of the test, and Table 1 shows the test conditions. After measuring flexural modulus of elasticity, the test speed was changed in order to measure flexural strength efficiently. For precise measurement of the deflection of the specimens, the test was performed by using a deflectometer in the displacement measurements.

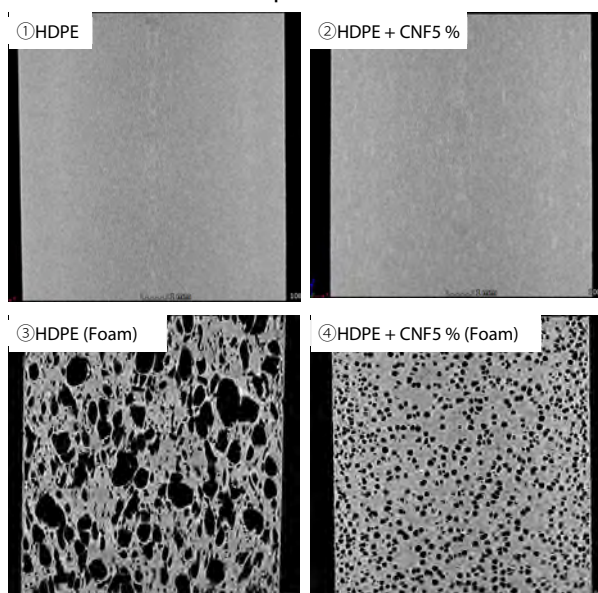


Fig. 1 CT Images



Fig. 2 Condition of Test

Table 1 Test Conditions

Instrument	AGS-X
Load Cell	1 kN
Test Fixture	Three-Point Bending Test Jig for Plastic (Punch R5, Supports R5)
Distance Between Supports	40 mm
Flexural Deflection Measuring Devices	Deflection Measuring Device for Three-Point Bending Test
Software	TRAPEZIUM X Single
Test Speed	1 mm/min → 20 mm/min
Number of Tests	3 Pieces/Specimen
Specimen Dimensions	50 mm × 10 mm × 4 mm

### Test Results

Fig. 3 shows the test results. With the CNF reinforced plastics (②, ④), brittle fracture occurred, as can be seen by the sharp decrease in test force after achieving maximum strength. The non-CNF plastics (①, ③) displayed ductile behavior, in which the test force decreased gradually.

Table 2 summarizes the test results for all specimens. The flexural modulus of elasticity was calculated from the slope of flexural strain of 0.05 % to 0.25 %. Comparing the values of the non-CNF HDPE (①, ③) and the CNF reinforced plastic (②, ④), the CNF reinforced plastic showed higher values for both the flexural modulus of elasticity and flexural strength. Moreover, comparing the coefficients of variation of the flexural strengths of the HDPE plastic foam (③) and the CNF reinforced plastic foam (④), it was found that variation of the CNF reinforced plastic was smaller.

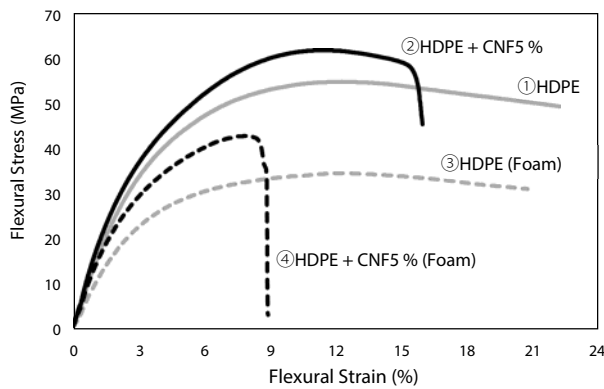


Fig. 3 Test Results

Table 2 Summary of Test Results (Average of n=3)

	Flexural Modulus of Elasticity (GPa)	Flexural Strength (MPa)	Coefficient of Variation of Flexural Strength (%)
① HDPE	1.29	55.2	0.7
② HDPE + CNF5 %	1.56	61.8	0.2
③ HDPE (Foam)	0.87	32.7	4.0
④ HDPE + CNF 5 % (Foam)	1.29	42.5	0.2

### Conclusion

It was possible to increase the flexural modulus of elasticity and flexural strength of plastic by adding CNF. In addition to improving those properties, in the case of plastic foam, it was also found that stable plastic foam molding, for example, without variations in void size, is possible by adding CNF.

Although various types of evaluation are necessary for application of CNF composite materials to members, evaluation of strength is one key item. In this study, the deflection of the specimens could be measured with high accuracy because a deflectometer was used. Accurate evaluation of the mechanical properties of materials containing CNF is possible by using Shimadzu measuring systems.



Find us on 



Linked 



 ResearchGate



Contact us

<https://www.shimadzu.com/an/contact/index.html>



First Edition: August, 2019



Shimadzu Corporation

[www.shimadzu.com/an](http://www.shimadzu.com/an)

**For Research Use Only. Not for use in diagnostic procedures.**

This publication may contain references to products that are not available in your country. Please contact us to check the availability of these products in your country.

The content of this publication shall not be reproduced, altered or sold for any commercial purpose without the written approval of Shimadzu. Company names, products/service names and logos used in this publication are trademarks and trade names of Shimadzu Corporation, its subsidiaries or its affiliates, whether or not they are used with trademark symbol "TM" or "®".

Third-party trademarks and trade names may be used in this publication to refer to either the entities or their products/services, whether or not they are used with trademark symbol "TM" or "®".

Shimadzu disclaims any proprietary interest in trademarks and trade names other than its own.

The information contained herein is provided to you "as is" without warranty of any kind including without limitation warranties as to its accuracy or completeness. Shimadzu does not assume any responsibility or liability for any damage, whether direct or indirect, relating to the use of this publication. This publication is based upon the information available to Shimadzu on or before the date of publication, and subject to change without notice.

© Shimadzu Corporation, 2019