

# FTIR

## TALK LETTER

Vol. 40



Publishing the 40th Volume of FTIR TALK LETTER — 02

AMsolution Control Software for  
AIRsight Infrared/Raman Microscopes  
and AIMsight Infrared Microscopes — 03

Infrared/Raman Spectroscopy Principle,  
AIRsight Design, and Analysis Example — 6

Infrared/Raman Microscope "AIRsight"  
Infrared Microscope "AIMsight" — 12

# Publishing the 40th Volume of FTIR TALK LETTER

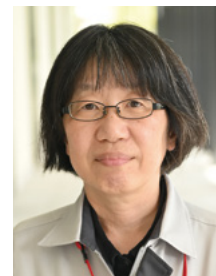

General Manager, Solutions Center of Excellence, Analytical & Measuring Instruments Division  
**Kiyomi Arakawa**

It gives me great pleasure to offer this 40th volume of FTIR TALK LETTER in this milestone 20th year since the letter was first published in the fall of 2003. Accordingly, I want to express my deep gratitude to all of the faithful readers.

It has also been five years since the 30th volume was published in the spring of 2018, so I also want to offer my sincere sympathies to all those that have suffered various consequences from COVID-19 infections. Experiencing the COVID-19 pandemic has accelerated reforms in our routine work practices, resulting in new paperless procedures, working remotely, conducting customer meetings via the Internet, and other irreversible new changes that have revealed a broader diversity in our senses of value.

At Shimadzu as well, the Global Marketing Department and Global Applications Development Center have been integrated into a Solutions Center of Excellence, with previous model-based organizations reorganized into market-based organizations for healthcare, green innovation, and materials/infrastructure markets in order to determine a proper understanding of customer business activities and their objectives for using analytical and measuring instruments and offer solutions that better serve customers.

Furthermore, in October 2022, the Hadano and Tokyo laboratory functions were integrated into the Tokyo Innovation Plaza (TIP), in the Tonomachi district of Kawasaki City, in order to promote new innovation through collaboration with neighboring organizations such as the National Institute of Health Sciences, Central Institute for Experimental Animals, and PeptiDream, and joint research partners. The advanced laboratory facilities will serve as a hub for connecting Shimadzu with customers or customers to other customers and as an outreach site for promoting the analytical science industry.

Going back to the topic of Shimadzu FTIR systems, a new AIRsight infrared/Raman microscope capable of both infrared and Raman measurements was released in November 2022 and a new AIMsight infrared microscope was released in February 2022 as the successor to the AIM-9000.

The AIMsight infrared microscope is equipped standard with functionality for automatically recognizing objects of interest. With a single click, the software can recognize objects and decide the optimal aperture size and angle settings within only one second. In addition, wide-field and microscope cameras are available for supporting sample observation to ensure even less experienced analysts can perform measurements with confidence.

In contrast, AIRsight infrared/Raman microscopes include all the AIMsight features indicated above, plus the ability to observe or measure samples with both infrared and Raman measurements at the identical micro-area without moving the sample. Infrared measurements enable qualitative analysis of organic substances, whereas Raman measurements enable qualitative analysis of either organic or inorganic substances such as titanium oxide or carbon. That means a single AIRsight system can be used to analyze contaminants even if it is not known whether they are organic or inorganic.

With the ongoing demand for EDX systems and contaminant analysis in food, electrical/electronic, and other fields, hopefully the utility of the AIRsight and AIMsight systems can be confirmed from specific applications or demonstrations.

In environmental fields, there is concern about the environmental impact of microplastics drifting in rivers and oceans on living organisms. Therefore, FTIR systems have been increasingly used in recent years to investigate the distribution of microplastics and identify their sources. FTIR TALK LETTER Vol. 35 and Vol. 37 describe such examples of using FTIR and infrared microscopes for analysis.

We also hope to obtain customer feedback about their desired functionality and incorporate it into designing the next generation of FTIR systems, so we look forward to receiving your ongoing support.

# AMsolution Control Software for AIRsight Infrared/Raman Microscopes and AIMsight Infrared Microscopes

Spectroscopy Business Unit, Analytical & Measuring Instruments Division  
**Kohei Hirono**

Recently, the AIRsight infrared/Raman microscope was released on November 16, 2022 and the AIMsight infrared microscope on January 31, 2023. Therefore, the following describes the new AMsolution control software used to control those infrared/Raman microscopes and infrared microscopes.

## 1. Introduction

This article describes the following five key features of the AMsolution software. Functionality marked with “both” in parentheses can be used with either AIRsight or AIMsight microscopes.

- Easily switch between infrared and Raman modes (AIRsight)
- Length measurement function (both)
- Depth measurement function (AIRsight)
- Automatic contaminant recognition system (both)
- Instrument validation (both)

## 2. Easily Switch between Infrared and Raman Modes

The measurement mode can be switched easily between infrared (IR) and Raman modes with one click of a button at the top of the AMsolution software window (Fig. 1).

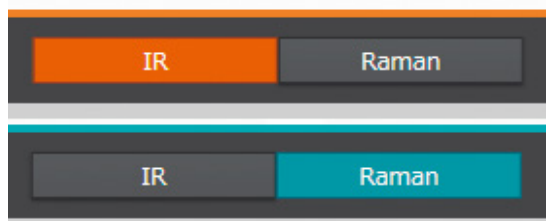

Fig. 1 Measurement Mode Buttons (shown with the IR mode selected above or Raman mode selected below)

The AIMsight includes optical systems for both infrared and Raman measurements built into the same microscope. That means both infrared and Raman measurements can be smoothly obtained from the same spot without having to move the sample.

Furthermore, AMsolution software is designed with minimal user interface differences between infrared and Raman modes to achieve an operating feel that is as similar as possible (Fig. 2). That means operations learned for one mode can be used to operate the microscope in the other mode without having to refer to the instruction manual or other documentation.

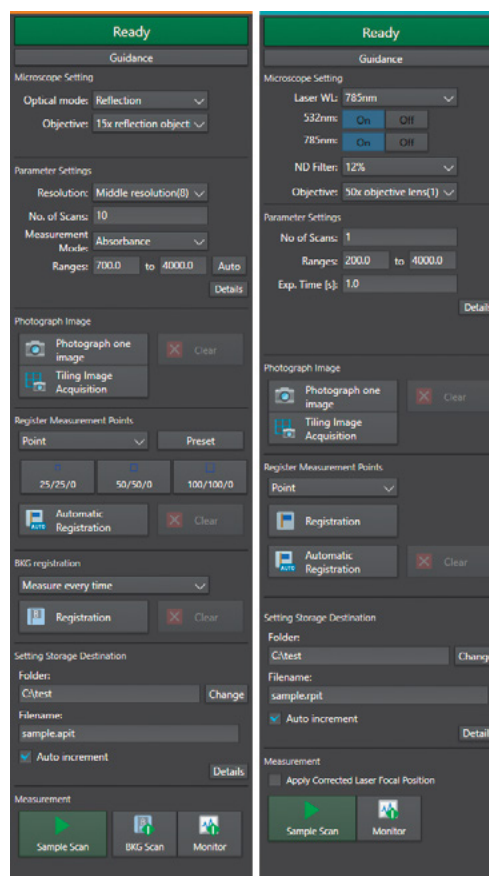

Fig. 2 Infrared Mode UI (Left) and Raman Mode UI (Right)

### 3. Length Measurement Function

The length measurement functionality included in AMsolution can be used to easily measure lengths on objects of interest in acquired images. Up to 60 measurement points can be registered and displayed on the image using a combination of numbers and lines. In addition to assigned numbers, measurement results are also indicated as numeric values (Fig. 3).

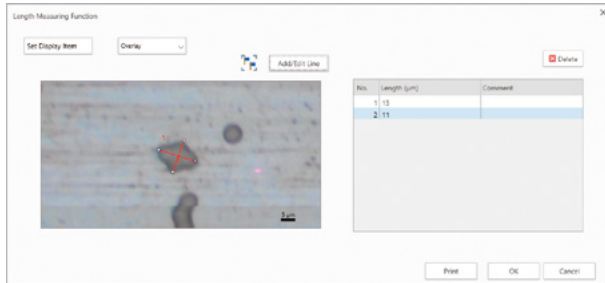

Fig. 3 Length Measurement Function Windows

Comments can be attached to each length measurement result for recording non-length information about the object, which allows more detailed information to be managed.

Furthermore, length measurement results can also be printed as a report by operating one button. As indicated in Fig. 4, reports include an image with all length measurement points shown, a table of length measurement results, and even a record of individual length measurement results.

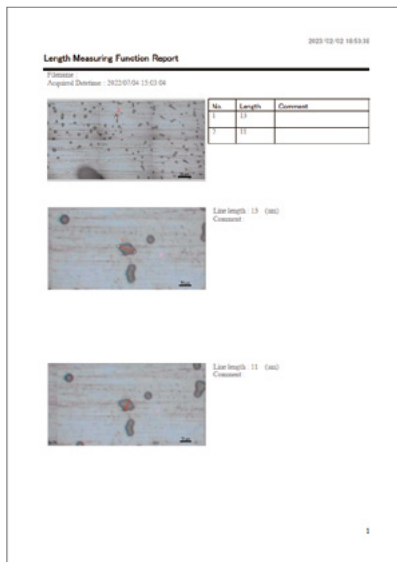

Fig. 4 Example of a Length Measurement Report

### 4. Depth Measurements

The Raman mode of AMsolution includes functionality for measuring depth in any transparent sample penetrable by laser light, which enables internal measurements in objects without pretreatment. Before starting depth measurements, the stage

position can be changed while performing monitoring measurements. Therefore, users can specify where to start and end measurements, the measurement range, and the intervals between measurements, on the window shown in Fig. 5, as they check monitoring measurement results.

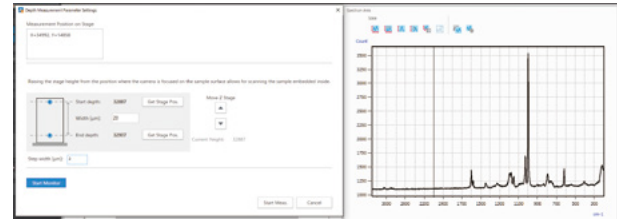

Fig. 5 Depth Measurement Setting Window

If the mapping program\* is used, depth mapping measurements can be measured in the specified linear direction, as shown in Fig. 6, which can be used to evaluate the cross sections of target objects.

\* The mapping program is optional.

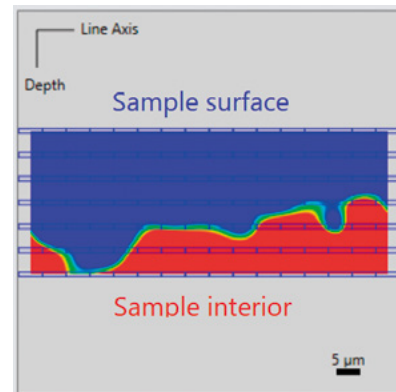

Fig. 6 Depth Measurement Results (Linear)

The user can freely select the best possible depth measurement sequence (lines) for the given sample from the four available choices.

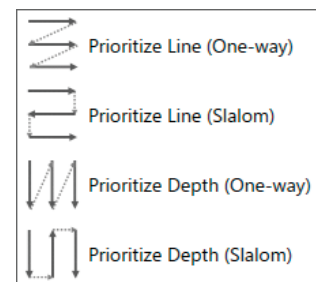

Fig. 7 Depth Measurement Sequence (Linear) Choices

## 5. Automatic Contaminant Recognition System

AMsolution also includes an automatic contaminant recognition system.

By simply clicking the [Automatic Registration] button after acquiring a microscope image, the software automatically identifies the objects of interest and registers the optimal measurement points for each object, as shown in Fig. 8. In the infrared mode, the software also automatically sets the aperture size and angle settings based on the size of the object of interest. Two aperture settings are available, either the standard aperture or the micro aperture, which can be selected based on objectives.

After the automatic contaminant recognition system automatically sets the measurement points and aperture setting, users can edit, delete, or even add additional points.

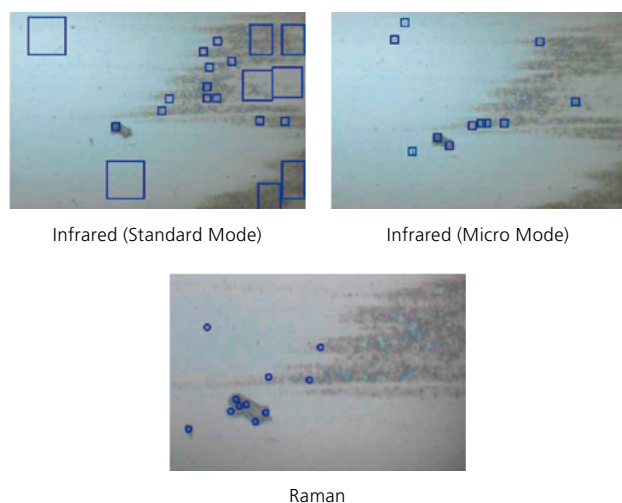

Fig. 8 Automatic Contaminant Recognition System Results

## 6. Instrument Validation

A validation program is included standard in AMsolution software for inspecting and verifying infrared and Raman microscope performance. The infrared mode is compliant with the Japanese Pharmacopoeia (JP), US Pharmacopoeia (USP), European Pharmacopoeia (EP), and Chinese Pharmacopoeia (ChP). The Raman mode is compliant with JP, USP, and EP modes.

The following inspections are required for infrared mode validation, but the inspection requirements are different for applicable pharmacopoeias in respective countries.

- Power spectrum\*1
- Resolution\*2
- Wavenumber accuracy
- Wavenumber repeatability\*3
- Transmittance (absorbance) repeatability\*4
- Peak separation function\*5

- \*1 This is Shimadzu's own requirement. The instrument status is evaluated based on the shape and size of the power spectrum. Customers can select whether or not to actually perform the inspection.
- \*2 Only the USP does not include this inspection. For USP validation, the user can choose whether or not to perform this inspection. (The default setting is for not performing this inspection.)
- \*3 This inspection is only required by the JP. For other pharmacopoeia validations, the user can choose whether or not to perform this inspection. (The default setting is for not performing this inspection.)
- \*4 This inspection is only required by the JP. For other pharmacopoeia validations, the user can choose whether or not to perform this inspection. (The default setting is for not performing this inspection.) Absorbance is used for the USP and EP, whereas transmittance is used for the JP and ChP, depending on the measurement technique defined in each pharmacopoeia.
- \*5 This inspection is only required by the ChP. For other pharmacopoeia validations, this inspection is not performed.

For Raman mode validation, wavenumber accuracy is inspected for all pharmacopoeias. However, the inspection can only be performed on an infrared/Raman microscope.

Validation results are displayed in a printable report, as shown in Fig. 9. Users can inspect systems using the validation program to ensure highly reliable data is obtained.

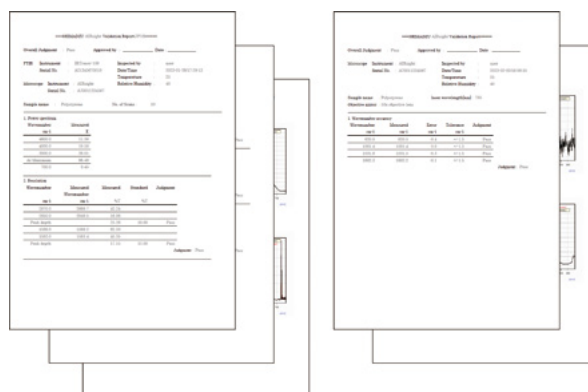

Fig. 9 Infrared Mode Validation Report (Left)  
Raman Mode Validation Report (Right)

## 7. Summary

As indicated above, AMsolution software enables both infrared and Raman measurements in the same spot and includes an automatic contaminant recognition system, length measurement functionality, and sophisticated data analysis capabilities.

Please try the AIRsight infrared/Raman microscope or AIRsight infrared microscope, together with AMsolution software for controlling either microscope, for yourself.

# Infrared/Raman Spectroscopy Principle, AIRsight Design, and Analysis Example

Solutions Center of Excellence, Analytical & Measuring Instruments Division  
Yoshiyuki Tange, Shoko Iwasaki, Yasushi Suzuki

Shimadzu released the AIRsight infrared/Raman microscope in November 2022. The AIRsight is a revolutionary microscope that can perform both infrared and Raman measurements in micro-areas without moving the sample. Both the infrared and Raman spectroscopy methods are classified as vibrational spectroscopy methods that display characteristic

natural frequencies of molecules as a spectrum, but are based on different principles and optical systems.

This article compares the principles used for Raman versus infrared spectroscopy, how the AIRsight is designed, and gives an example of analysis using the AIRsight.

## 1. Measurement Principles of Infrared and Raman Spectroscopy

Both infrared and Raman spectroscopy are vibrational spectroscopy methods that use information about the vibrational characteristics of molecules. Both techniques can be used for molecular structural analysis, quantitative analysis, and identification of substances by comparing spectra to a library of spectral data or existing spectra.

First, the differences between infrared and Raman spectroscopy will be explained based on the type (wavelengths) of light used.

Fig. 1 illustrates the relationship between light and molecular vibrations that is used for infrared spectroscopy. Infrared spectroscopy irradiates samples with energy (mid-infrared light) that is equivalent to the molecule's fundamental vibration and then determines the sample's molecular structures based on the light absorption characteristics. The irradiated light (incident light) and detected light (transmitted light) have basically the same frequency.

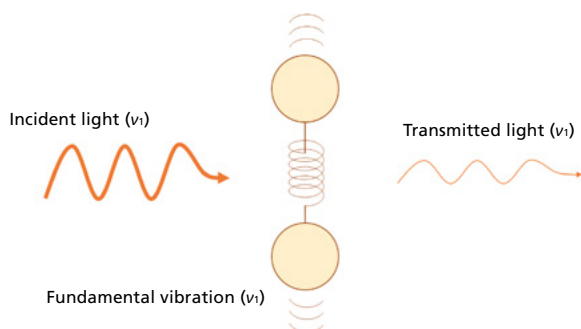

Fig. 1 Relation between Infrared Absorption and Molecular Vibration

Fig. 2 illustrates the relationship between molecular vibrations used for Raman spectroscopy. Raman spectroscopy irradiates samples with energy that is far greater than the molecule's fundamental vibration (such as visible or near-infrared light) and then investigates molecular structures based on the slight quantities of Raman-scattered light present in the light that is scattered by the sample. The light referred to as Raman-scattered light detected by Raman spectroscopy has a frequency ( $\nu - \nu_1$ ) that is equal to the excitation light frequency ( $\nu$ ) minus the molecular fundamental vibration frequency ( $\nu_1$ ).

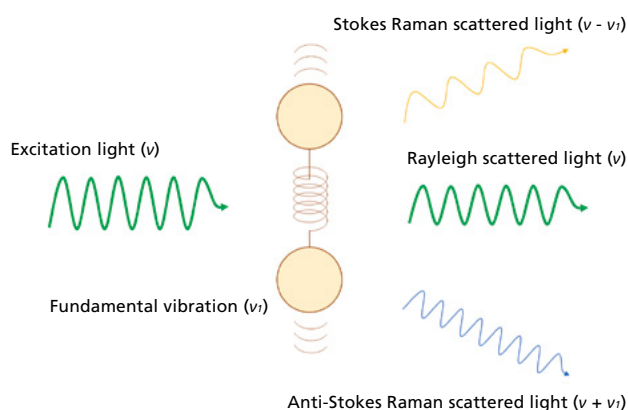

Fig. 2 Relation between Raman Scattering and Molecular Vibration

Next, a diagram of energy transitions for infrared absorption and Raman scattering is shown in Fig. 3. Though based on different measurement principles, both can provide information about molecule vibration, with wavenumber plotted on the horizontal axis for infrared spectroscopy and Raman shift (wavenumber difference between excitation light and Raman scattering light) on the horizontal axis for Raman spectroscopy.

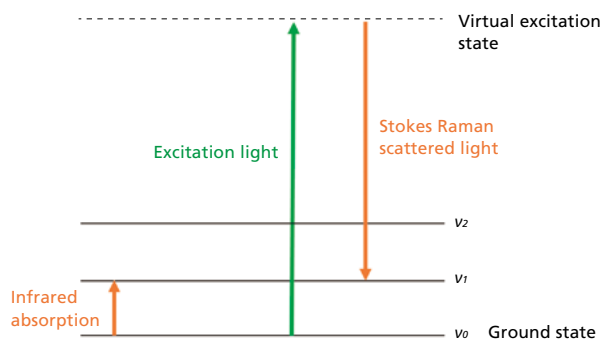

Fig. 3 Energy Transitions of Infrared Absorption and Raman Scattering

Infrared and Raman spectroscopy methods also differ in terms of how they spectroscopically absorb or scatter light.

Both infrared and Raman spectroscopy are analytical techniques that measure the vibration of molecules, but they differ in how they can detect molecular vibration (vibration modes). The vibration modes detectable by infrared spectroscopy are referred to as “IR-active,” whereas the vibration modes detectable by Raman spectroscopy are referred to as “Raman-active”<sup>[1,2]</sup>. In general, molecular vibrations that involve electric field polarization are said to be IR-active, whereas molecular vibrations that involve volumetric variations are said to be Raman-active. For example, the symmetric stretching vibration of CO<sub>2</sub> is Raman-active because it involves volumetric variations, but is IR-inactive because it does not involve electric field polarization. In contrast, antisymmetric stretching and bending vibrations are IR-active but not Raman-active because they involve electric field polarization without volumetric variations. Thus, CO<sub>2</sub> and other molecules with a center of symmetry have a complementary relationship between infrared and Raman spectroscopy referred to as a mutual exclusion rule. Many molecules, macromolecular materials, and other substances without a center of symmetry have fundamental vibrations that are IR- and Raman-active, but the position, intensity, and shape of detected peaks differ due to the different selection principles involved. For example, an overlay of infrared and Raman spectra is shown in Fig. 4. It shows how bonds between different atoms, such as C=O and C-O-C, are detected with relatively high intensity in infrared spectra, but bonds between identical atoms, such as C=C, are detected with high intensity in Raman spectra.

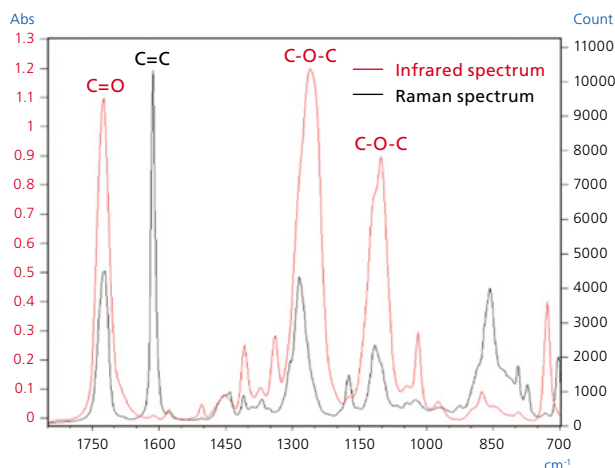

Fig. 4 Infrared and Raman Spectra of Polyester

The above describes the differences in light (wavelength) used for infrared and Raman spectroscopy and the corresponding selection principles.

## 2. AIRsight Microscope Design

This section describes how the AIRsight microscope design is configured. Fig. 5 shows an AIRsight microscope connected to an IRXross Fourier transform infrared spectrophotometer. The AIRsight optical system is illustrated in Fig. 6. The infrared light used for infrared measurements is supplied from the main FTIR system (an IRXross model in this case). The laser unit and Raman spectrometer used for Raman measurements are installed in the AIRsight unit. AMsolution control software is used to switch between the optical paths for infrared and Raman measurements, as described in FTIR TALKLETTER Vol. 40 “AMsolution Control Software for AIRsight Infrared/Raman Microscopes and AIRsight Infrared Microscopes.”



Fig. 5 AIRsight Microscope Connected to an IRXross Fourier Transform Infrared Spectrophotometer

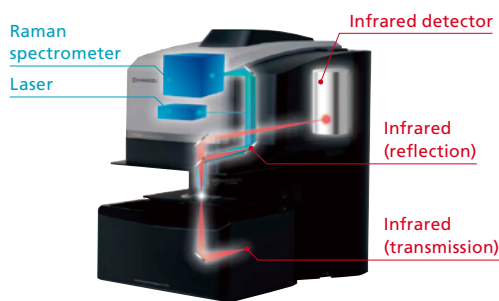

Fig. 6 Illustration of AIRsight Optical System

Next, diagrams of the optical systems used for infrared and Raman measurements are shown in Fig. 7 and 8, respectively. The optical system used for infrared measurements is composed of an infrared light inlet, sample stage (same for both infrared and Raman), reflective objective mirror, transmittance condensing mirror, aperture, condensing mirror, detector, wide-field camera (same for both infrared and Raman), and microscope camera. Please refer to FTIR TALK LETTER Vol. 37 “Optical Systems in Infrared Microscopes” for details. In contrast, the optical system in Raman microscopes is composed of a laser light source, neutral density (ND) filter used to reduce the light level, sample stage (same for both infrared and Raman), wide-field camera (same for both infrared and Raman), objective lens, spectrometer, and detector. Using a confocal optical system for Raman measurements enables measurements with high spatial resolution. For more details about the wide-field camera used for both infrared and Raman measurements, refer to FTIR TALK LETTER Vol. 27 “Infrared Microscope—Convenience of a Wide-View Camera.”

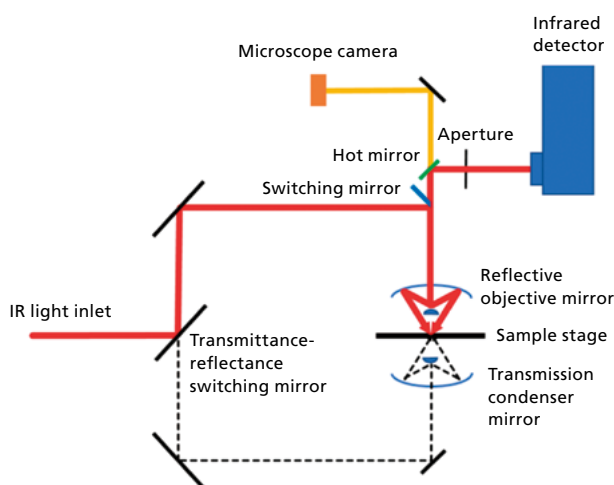

Fig. 7 Optical System for Infrared Measurements

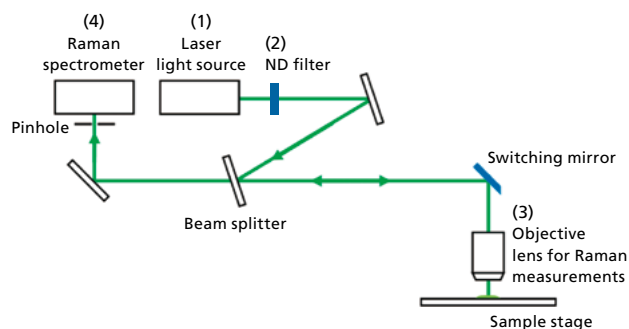

Fig. 8 Optical System for Raman Measurements

Each of those AIRsight optical system components used for Raman measurements is described below.

### (1) Laser Light Source

The AIRsight is equipped standard with two solid-state semiconductor excitation lasers for 532 nm and 785 nm light.

The 532 nm laser provides higher intensity Raman scattering conducive for achieving higher intensity peaks, but fluorescent light from samples has been known to result in higher baseline levels that can prevent peak detection. In such cases, “photobleaching” functionality can reduce the impact of fluorescent light by irradiating samples for a certain period before measurements with a laser light that is not quite intense enough to scorch the samples. (Photobleaching is intended to reduce fluorescence effects, but cannot completely eliminate the effects.)

In contrast, the 785 nm laser is less prone to fluorescence effects, but results in a narrower wavenumber measurement range, due overlap between the laser light source and the detector ranges. The measurement range using the 532 nm laser is 4,000 to 150  $\text{cm}^{-1}$ , whereas the measurement range for the 785 nm laser is 3,200 to 150  $\text{cm}^{-1}$ . That means it may not be able to detect peaks for components with stretching vibration or other peaks in the 4,000 to 3,200  $\text{cm}^{-1}$  region. Consequently, Shimadzu recommends first using the 532 nm laser and then using the 785 nm laser for samples with strong fluorescence.

Due to the lasers used for AIRsight Raman measurements, the system includes a light-blocking sample stage cover to shield the samples from exposure to laser light. A safety mechanism is included that shuts off the laser light if the cover is opened during measurements.

### (2) ND Filter

In Raman spectroscopy, the expression to “scorch” samples is sometimes used. If samples are irradiated with high-intensity laser light, it can scorch some samples, which changes the chemical composition. In such cases, sample damage (scorching) can be prevented by starting with a low intensity level and then gradually increasing the intensity. That is accomplished using an ND filter. Laser intensity can be varied by inserting the



ND filter next to the laser source output port to reduce the light level. Typically, obtaining Raman spectra with low noise levels requires keeping laser intensity as high as possible, but that can scorch some samples and prevent their analysis. The lower the light absorption characteristics of a sample (transparent, scorch, etc.), the less likely it is to scorch, whereas black samples tend to scorch easily. By gradually increasing laser intensity, suitable values can be measured without significantly damaging the sample.

### (3) Objective Lens for Raman Measurements

Objective lenses with 50x or 100x magnification can be installed depending on the size of the object being observed.

Due to the confocal optical system used, AIRsight microscopes can obtain information from the interior of plastic, glass, or other transparent samples that laser light can penetrate by focusing the laser inside the sample. Even if the sample is colored or cloudy, rather than clear, internal measurements are possible as long as the interior can be observed.

### (4) Raman Spectrometer (Detector)

The electronically-cooled 2,048 × 264-pixel CCD detector can detect Raman light with high sensitivity. The detector elements are cooled with a Peltier element and internal heat is discharged by an internal fan. Because the sensitivity of the CCD detector depends on the wavelength, the resulting Raman spectra reflect the sensitivity characteristics of the detector. However, the data processing functionality in AMsolution control software includes a detector sensitivity correction function that can compensate for such characteristics. That means the data processing functionality can be used to compare spectra measured using different excitation wavelength settings.

The AIRsight system design, optical system, and the components included particularly in the Raman microscope, such as the light source, ND filter, objective lens, and spectrometer (detector) were described above.

## 3. Example of Analysis Using the AIRsight

Infrared microscope users are sometimes concerned about the following issues when analyzing contaminants, defects, or materials.

- (1) The target sample is too small to be measured with an infrared microscope.
- (2) Contaminant components cannot be identified with an infrared microscope alone.
- (3) Both organic and inorganic components need to be analyzed in detail.

The following describes examples of using the AIRsight to resolve such concerns or satisfy other needs.

### (1) The target sample is too small to be measured with an infrared microscope.

When measuring micro-areas with an infrared microscope, typically the aperture size is set to the smallest measurement range possible, which is about 10  $\mu\text{m}$  square. If the aperture is set smaller than 10  $\mu\text{m}$  square, light diffraction effects can make it difficult to obtain valid spectra. AIRsight Raman measurements are especially useful in such cases. Because a laser is used as the light source for Raman measurements, even smaller regions can be measured. An example of measuring a 1  $\mu\text{m}$  diameter polystyrene bead is shown in Fig. 9. The bead was measured using a 100x magnification objective lens with a spatial resolution of 3  $\mu\text{m}$  or less. The results confirm that AIRsight Raman measurements can provide good spectra even for microscopic samples from which data is difficult to acquire with an infrared microscope.

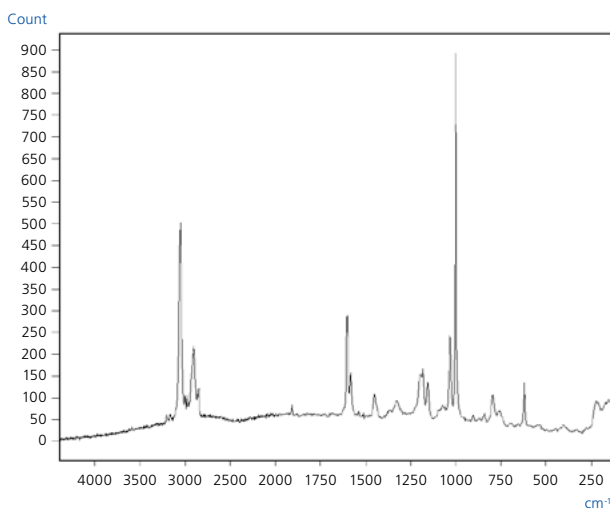

Fig. 9 Raman Spectrum of Polystyrene Bead (1  $\mu\text{m}$  dia.)

### (2) Contaminant components cannot be identified with an infrared microscope alone.

AIRsight infrared measurements were used to analyze a normal surface of a pharmaceutical tablet and a surface with a contaminant attached. The infrared spectra obtained are shown in Fig. 10. The infrared spectrum of the normal area indicated that the principal component is mannitol. However, it did not detect infrared peaks from the contaminant area, so the source of the contaminant could not be determined.

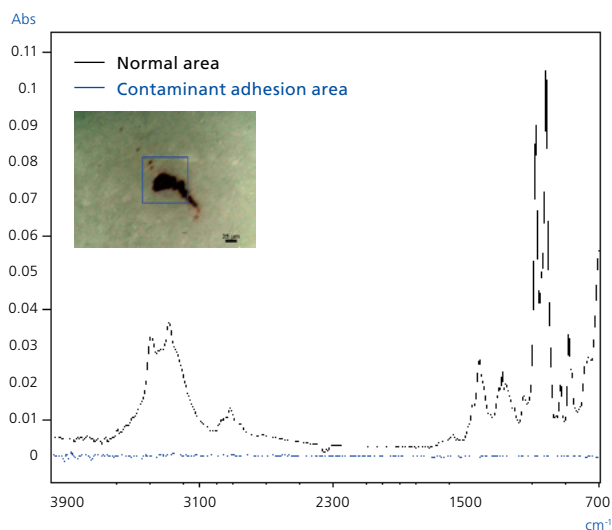

Fig. 10 Infrared Spectra of Normal and Contaminant Adhesion Areas

Next, AIRsight Raman measurements were used to analyze a surface with a contaminant attached. The Raman spectrum obtained from the area where the contaminant is attached and a Raman spectrum of iron oxide, the suspected contaminant, are shown overlaid in Fig. 11. The close match between the two Raman spectra indicates that the contaminant attached to the tablet surface is probably iron oxide. That demonstrates how the Raman measurement was able to identify the iron oxide that could not be identified with infrared measurements.

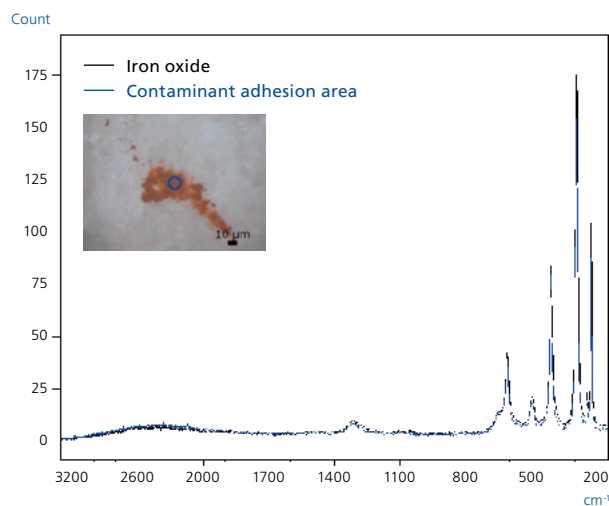

Fig. 11 Raman Spectra of Attached Contaminant and Iron Oxide

### (3) Detailed analysis of both organic and inorganic components is desired.

Raman measurements of a packaging material used for a hair rinse solution, which is a type of hair care product, were mapped. An image for visual observation of the packaging material and the measurement positions are shown in Fig. 12. The resulting Raman spectra are shown in Fig. 13. In this case, measurements were focused near the boundary surface between the second and third layers of the multilayer film packaging material.

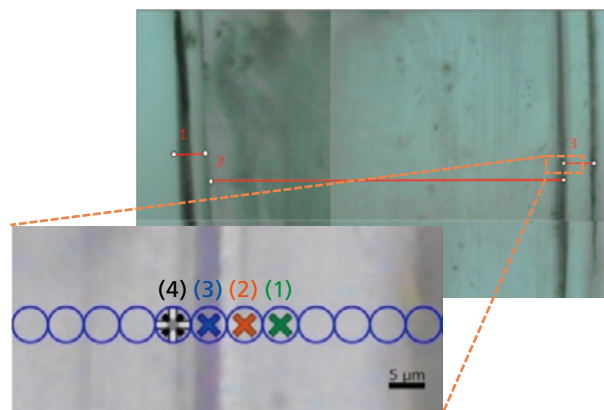

Fig. 12 Visual Observation Image and Measurement Positions on Packaging Material Cross Section

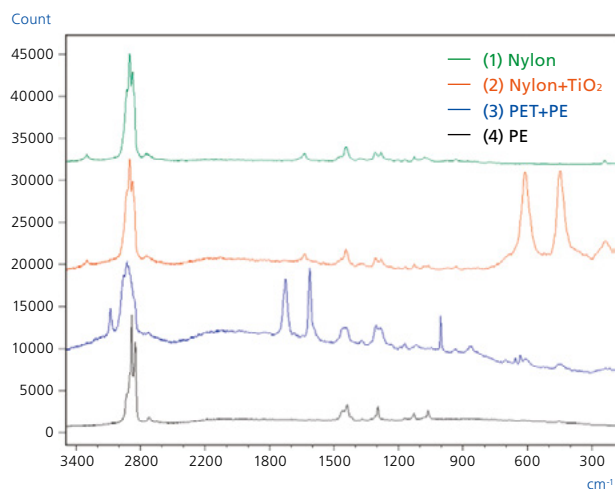

Fig. 13 Raman Spectra Measured Near the Boundary between the 2nd and 3rd Layers

Though not indicated here, AIRsight infrared measurements detected Nylon and polyethylene (PE) only. In contrast, Raman measurements not only detected Nylon and PE but also peaks from polyethylene terephthalate (PET) and titanium oxide (TiO<sub>2</sub>) from near the boundary surface.

Fig. 14 shows Raman spectra for TiO<sub>2</sub> with two different structures. The Raman spectrum (2) in Fig. 13 closely matches the spectrum for rutile TiO<sub>2</sub>.

The TiO<sub>2</sub> peaks appeared toward the low wavenumber end of the spectrum, so they were difficult to qualitatively identify in infrared measurements due to inadequate detector sensitivity in the given micro-area measured. In infrared measurements, the TiO<sub>2</sub> results in broad absorption peaks toward the low-wavenumber end, which make them difficult to differentiate from other inorganic oxides. In such cases, AIRsight Raman measurements can be used to analyze micro-areas that are difficult to measure with infrared light or to qualitatively analyze inorganic compounds such as TiO<sub>2</sub>.

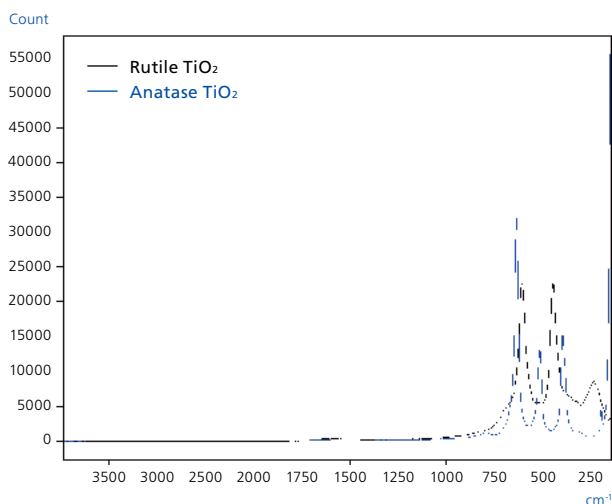

Fig. 14 Raman Spectra of TiO<sub>2</sub>

## 4. Summary

This article describes the infrared and Raman spectroscopy measurement principles, the system design, optical system, and key components included in AIRsight systems, particularly in Raman microscopes. Raman measurements are especially useful for measuring micro-areas smaller than 10 μm or inorganic compounds, which are difficult to analyze based on infrared measurements. On the other hand, infrared measurements, rather than Raman, may be more effective in measuring many plastics that emit fluorescent light. A single AIRsight microscope can perform both infrared and Raman measurements in the same micro-area, which makes a superior microscope for a wide variety of analytical applications. It can also visualize the distribution of components by creating a chemical image based on mapping measurement results obtained from both measurement modes. Please try this truly unique product from Shimadzu.

## References

- [1] Takeshi Hasegawa, Yukihiro Ozaki, Experts Series for Analytical Chemistry Instrumentation Analysis: Vol. 2 Infrared Spectroscopy & Raman Spectroscopy, Kyoritsu Shuppan (2020)
- [2] Hiro-o Hamaguchi, Koichi Iwata, Spectroscopy Series 1—Raman Spectroscopy, Kodansha (2015)

Infrared/Raman Microscope

# AIRsight

Raman and FTIR microscopy  
in perfect harmony

Infrared Microscope

# AIMsight

## Combining Two Analytical Techniques to Provide Complementary Molecular Information

- Both FTIR and Raman spectra can be measured on the same stage without moving samples (AIRsight)
- Microscope serves two purposes to help save space (AIRsight)
- Wide-field camera with high image quality is included standard
- Length measurement functionality for measuring dimensions in measurement object of interest is included standard
- Spectrum advisor function for supporting analysts is included standard

Infrared/Raman Microscope

## AIRsight



Product >

Infrared Microscope

## AIMsight



Product >



Shimadzu Corporation

[www.shimadzu.com/an/](http://www.shimadzu.com/an/)

**For Research Use Only. Not for use in diagnostic procedures.**

This publication may contain references to products that are not available in your country. Please contact us to check the availability of these products in your country.

Company names, products/service names and logos used in this publication are trademarks and trade names of Shimadzu Corporation, its subsidiaries or its affiliates, whether or not they are used with trademark symbol "TM" or "®".

Third-party trademarks and trade names may be used in this publication to refer to either the entities or their products/services, whether or not they are used with trademark symbol "TM" or "®".

Shimadzu disclaims any proprietary interest in trademarks and trade names other than its own.

The contents of this publication are provided to you "as is" without warranty of any kind, and are subject to change without notice. Shimadzu does not assume any responsibility or liability for any damage, whether direct or indirect, relating to the use of this publication.