

# The Dual LC Concept for Productivity Increase in Various Applications and Industries

Sylvia Grosse, Denis Andrei Ispan, Frank Steiner  
Thermo Fisher Scientific, Germering, Germany

## Introduction

In research and development or quality control laboratories of industries such as pharmaceutical, biotechnology or food & beverage, the number of (ultra) high performance liquid chromatography ((U)HPLC) analysis is tremendous. As a result, up to several dozen systems must be operated in one laboratory. The Thermo Scientific™ Vanquish™ Duo for Dual LC offers an ideal solution to significantly increase productivity. The system provides two separate flow paths with the footprint of a single (U)HPLC system, doubling throughput while efficiently utilizing laboratory bench space. Consequently, more applications can be performed with the same number of systems in one laboratory. In this work, four approaches are presented that benefit strongly from the unique Dual LC concept. One approach describes the simultaneous analysis of water-soluble and fat-soluble vitamins which, due to their very different hydrophobicities, require completely independent chromatographic methods, making analysis using the same method difficult. A second approach demonstrates how throughput can easily be doubled when identical methods are run on both flow paths, as is often the case with isocratic stability-indicating methods for pharmaceuticals. In a third example, the parallel measurement of an assay and impurity determination of an active pharmaceutical ingredient (API) is shown. Here, the chromatographic methods and/or sample concentration are typically very different and can pose challenges to determine the content of API and related impurities in one run. Lastly, the fourth case describes an accelerated method development to separate mRNA from its post-transcriptional impurities using a time-effective scouting approach.

## Instrument configurations

### Setup 1

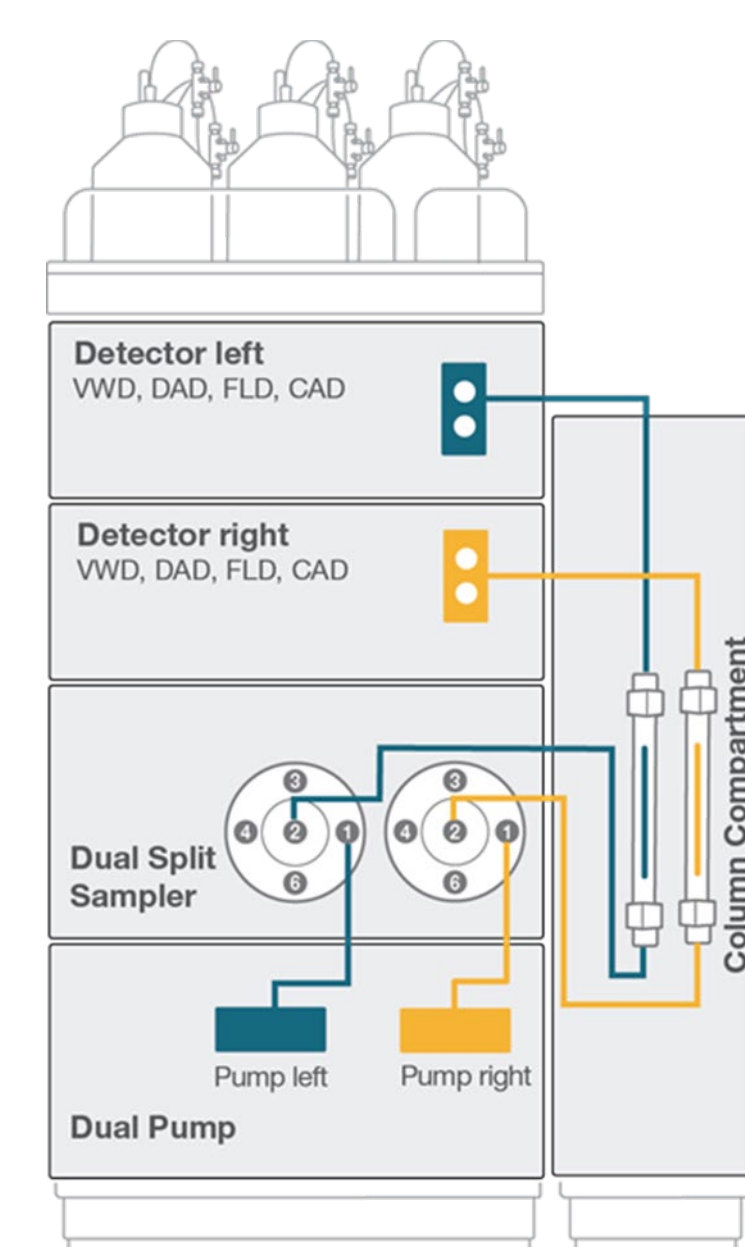

**Figure 1. Schematic instrument configuration of the Vanquish Duo for Dual LC with one column compartment.**

Two independent pumps in one housing.  
Two injection valves with two sample loops in one housing.  
Two columns in one column compartment or optionally a second column compartment can be installed.  
Any combination of two detectors possible.

### Setup 2

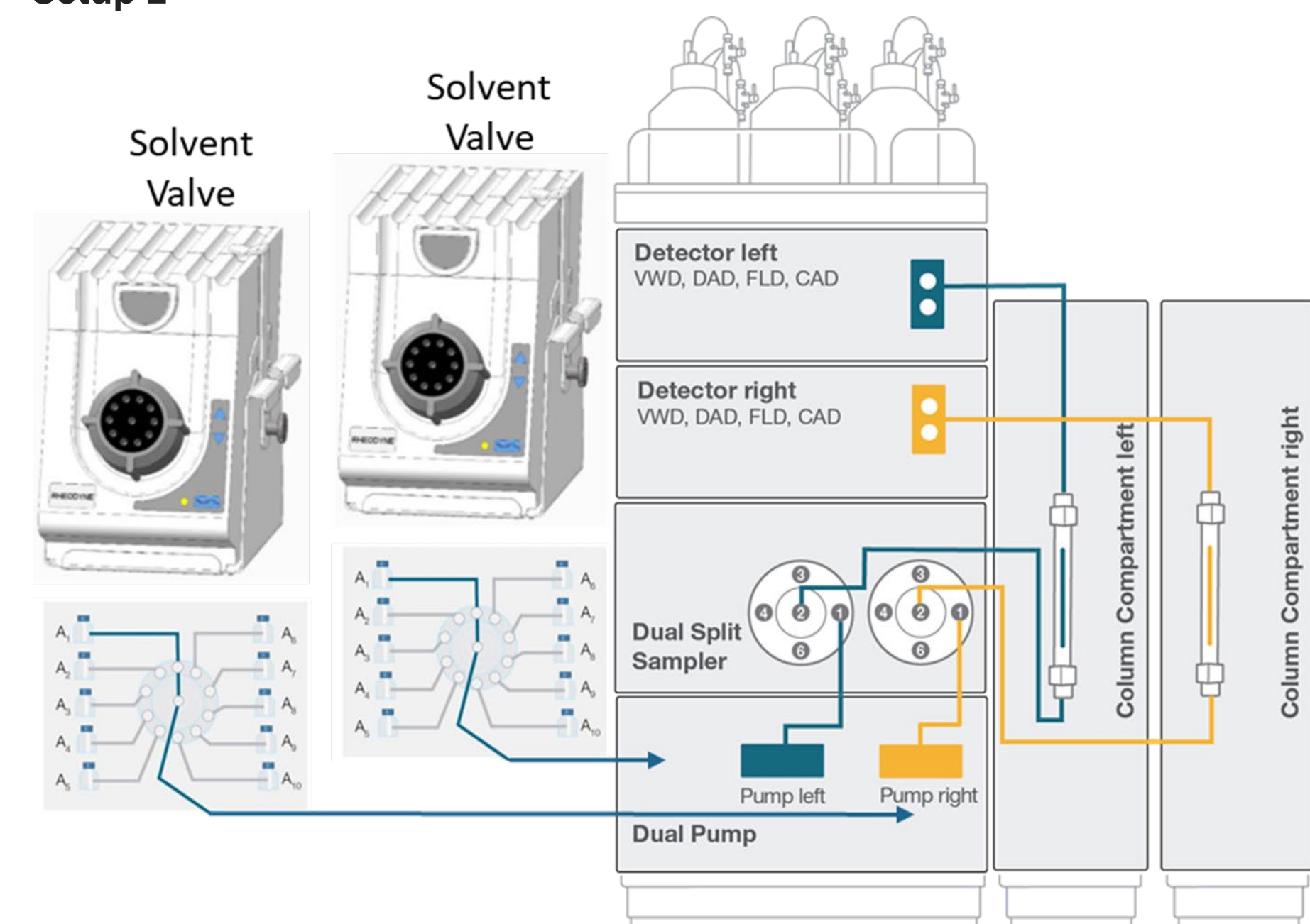

**Figure 2. Schematic instrument configuration of the Vanquish Duo for Dual LC with two solvent selection valves and two column compartments.**  
This setup enables accelerated method development

### Approaches that strongly benefit from the Dual LC are

- Two completely independent applications
- Two applications that use the same eluents but with different gradient methods and/or different target analyte concentration
- One method performed simultaneously on both flow paths to double throughput
- Method development and validation (e.g., robustness testing by testing columns from different batches)
- Mass balance study for the same set of samples of an API, where an optical (e.g., UV) and a non-optical (e.g., CAD) detector are required

## Results

### Application 1: Same chromatographic methods and samples applied to both flow paths

The Vanquish Flex Duo system for Dual LC (setup 1) was used for the analysis of a stressed drug mixture of ezetimibe (EZE) and simvastatin (SMV). It enabled the simultaneous analysis of two samples, doubling the throughput of the stability-indicating method [1].

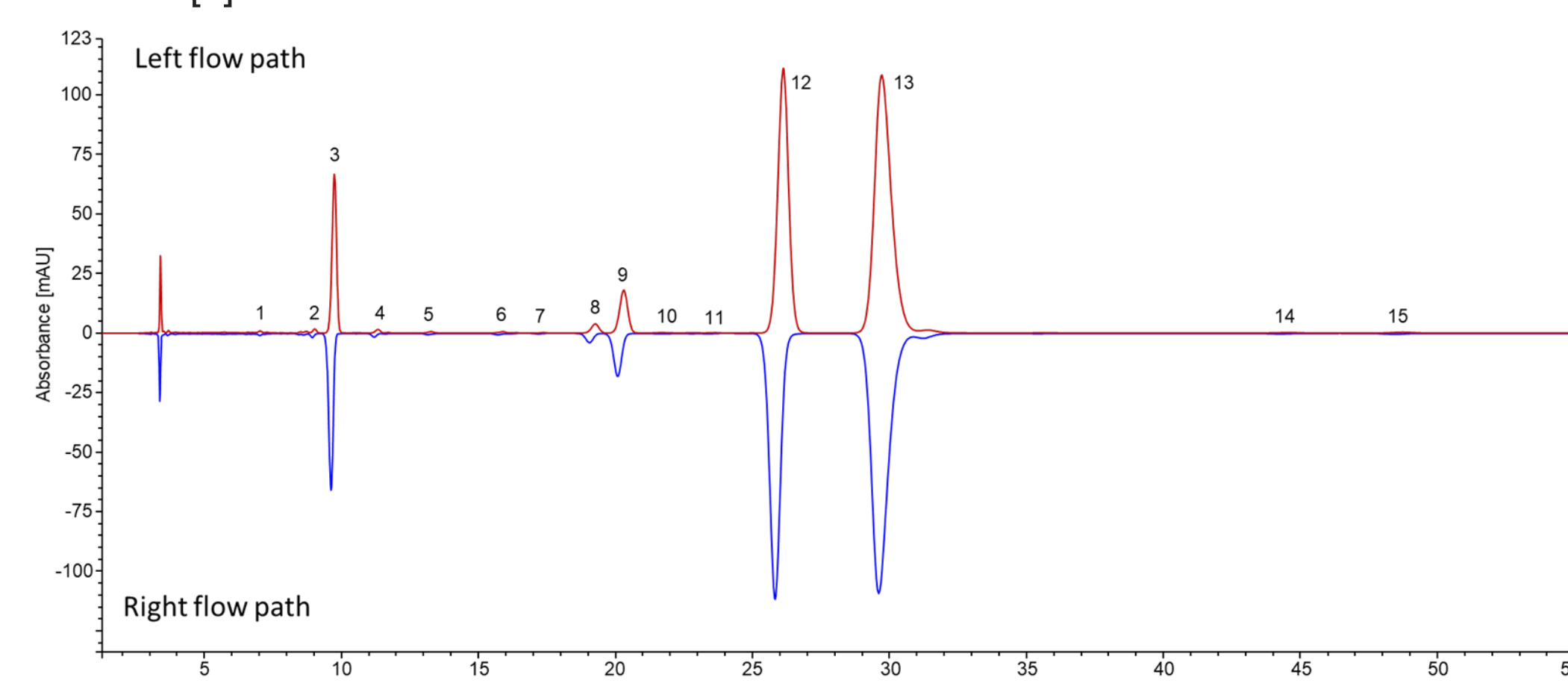

**Figure 3. Mirrored chromatograms of the stressed mixture of EZE and SMV tablets (red: left flow path, blue: right flow path); Peak number assigned to all components with relative peak area > 0.05 %.**

### Application 2: Two different methods with shared eluents

Simultaneous analysis for drug content and impurity determination of esomeprazole magnesium based on the USP monograph were performed on a Vanquish Flex Duo for Dual LC (setup 1) [2].

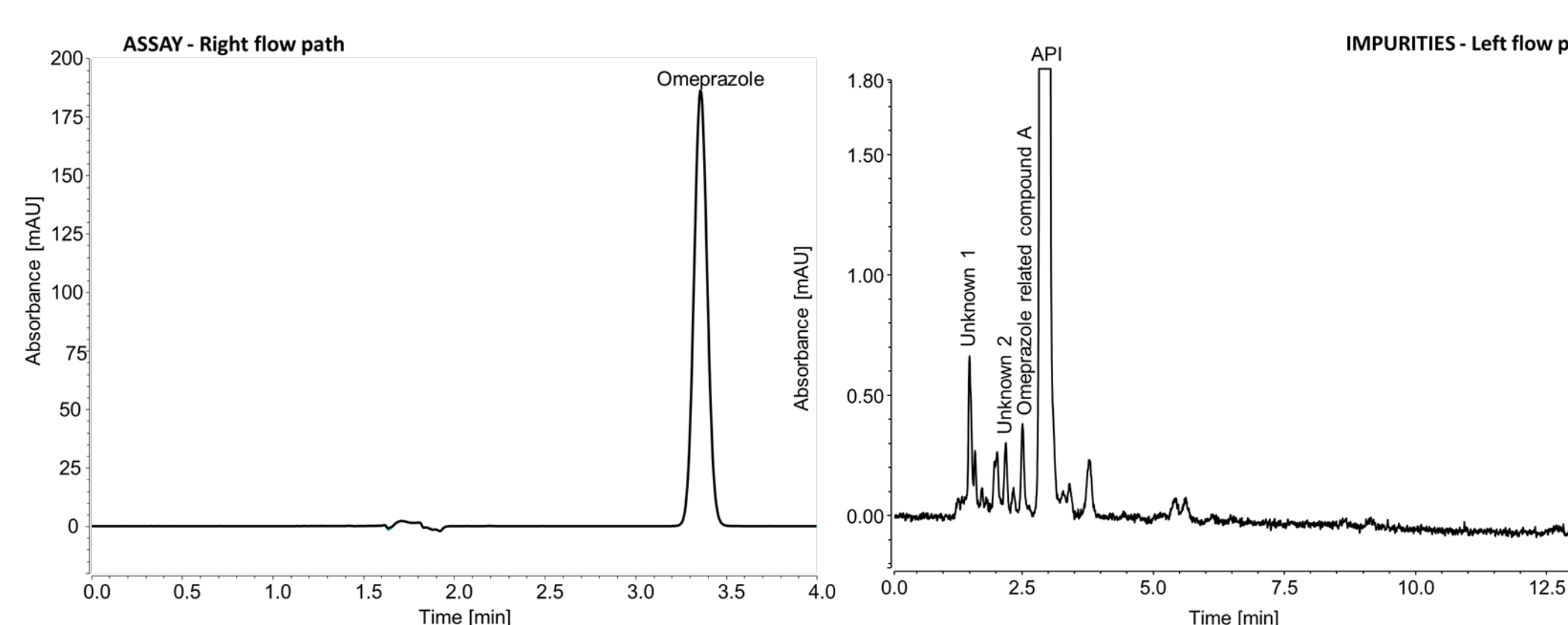

**Figure 4. Assay: Overlaid chromatograms of six replicate injections of the standard solution (assay) containing 0.05 mg/mL USP Omeprazole. Impurities: Chromatogram obtained for sample (impurity) containing 0.16 mg/L API.**

### Application 3: Two completely independent chromatographic methods

This workflow describes quantitative analysis of fat-soluble (FSV) and water-soluble Vitamins (WSV) in drinks and food supplement tablets using the Vanquish Flex Duo UHPLC system for Dual LC (setup 1) [3]. It enables the independent and simultaneous use of two separate methods, with different columns in one instrument.

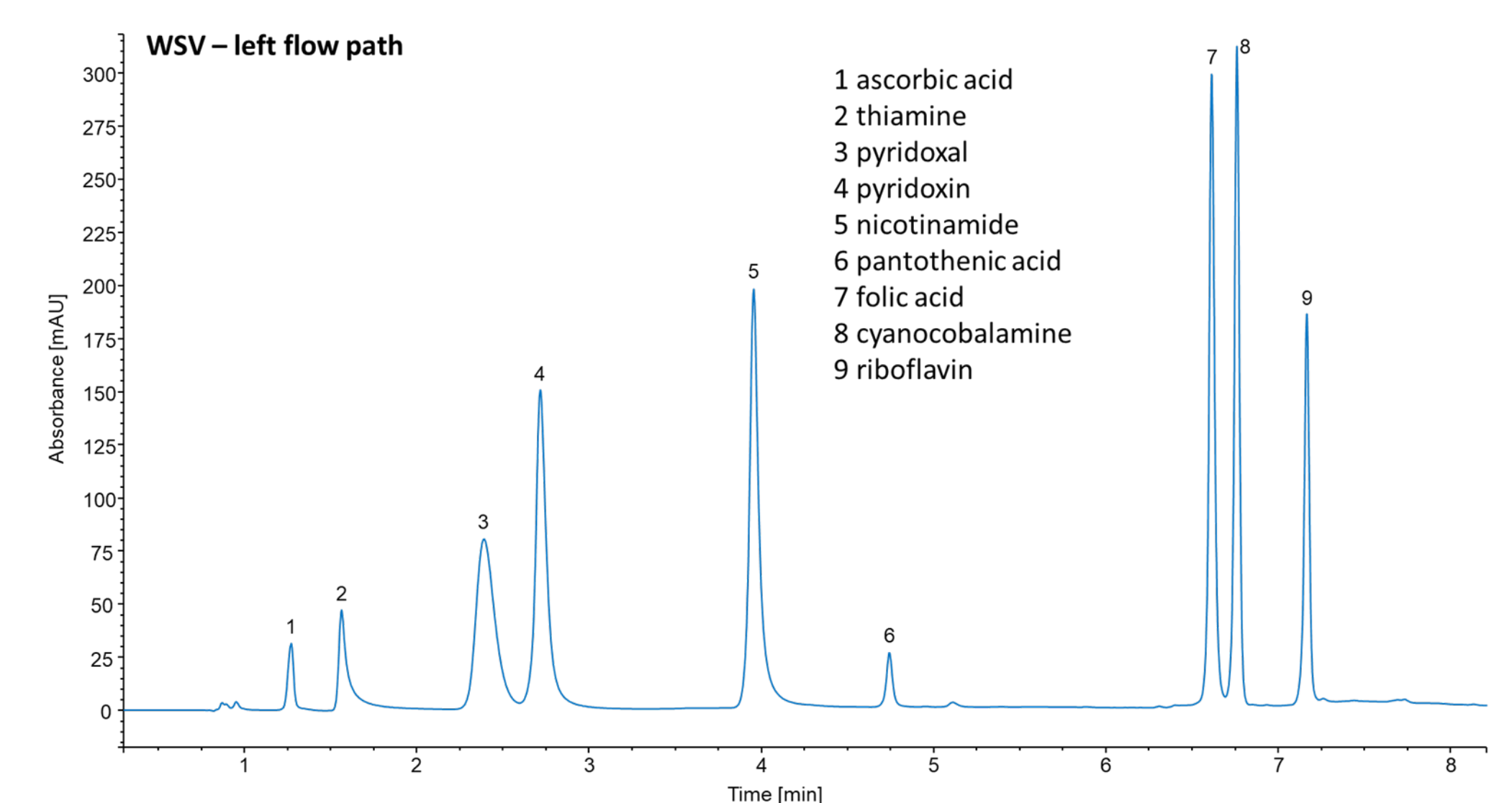

**Figure 5. Separation of water-soluble vitamins standard on an Acclaim™ PA2 column (150 x 2.1 mm, 2.2 μm) recorded at 210 nm.**

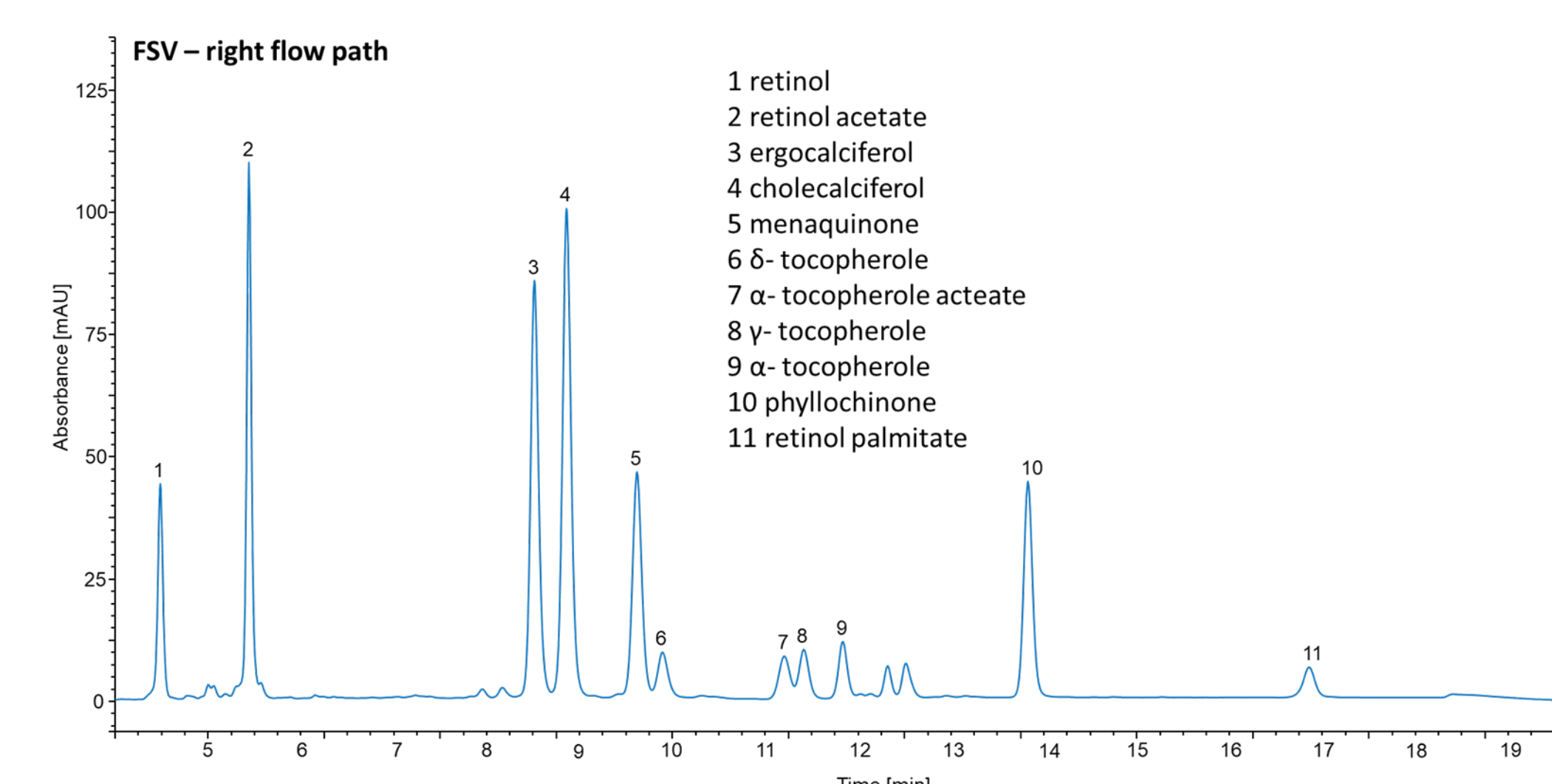

**Figure 6. Separation of fat-soluble vitamins standard on an Acclaim™ PA2 column (250 x 2.1 mm, 2.2 μm) recorded at 280 nm.**

### Application 4: Simultaneous method development for different separation chemistries (IEX and IP-RP)

The Vanquish Duo for Dual LC combined with the Method Scouting Kit (setup 2) offers a valuable solution for determining the most promising chromatographic conditions in a time-effective manner. With the Vanquish Duo system, two independent chromatographic chemistries (IEX and IP-RP) are scouted on the same system at the same time, which enables faster method development and requires less instrumentation [4].

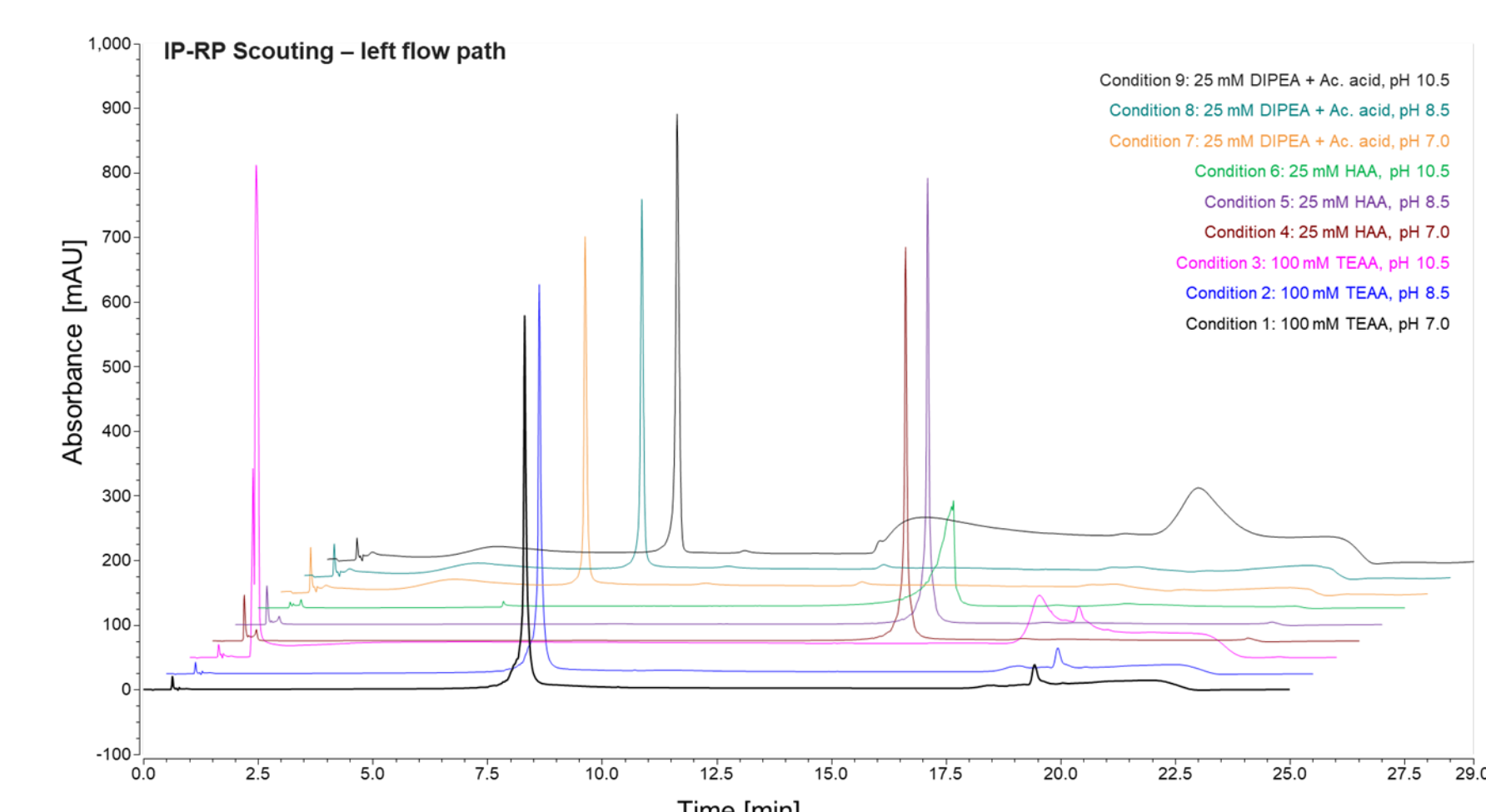

**Figure 7. IP-RP purified mRNA scouting conditions overlay at 50 °C. 1 μL injection. mRNA is the most intense peak.**

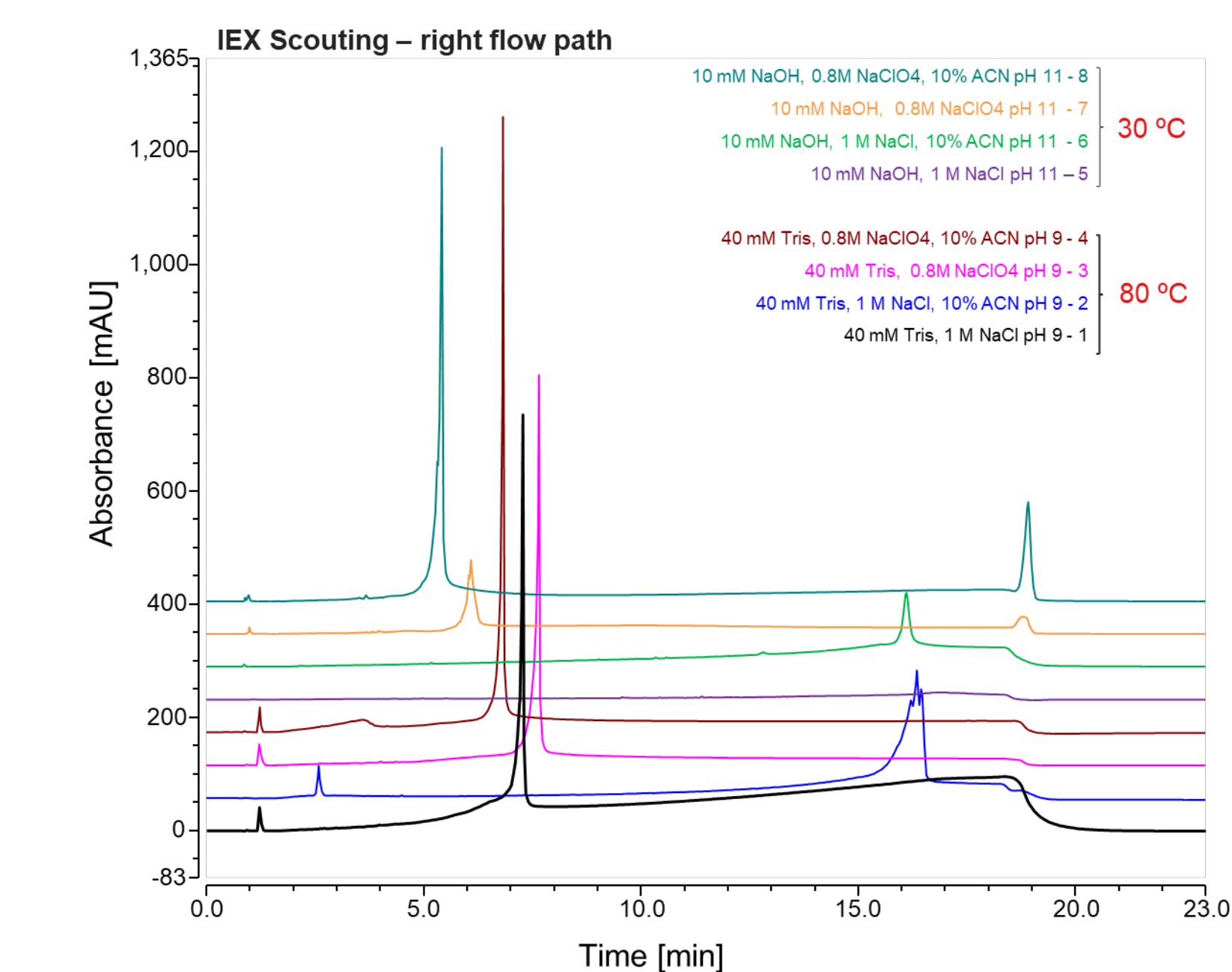

**Figure 8. IEX purified mRNA scouted buffers and temperatures. Conditions 1–4 were analyzed at 80 °C. Conditions 5–8 were analyzed only at 30 °C.**

## Conclusions

- Chromatographic results of both flow paths of the Vanquish Flex Duo system for Dual LC exhibit very good consistency both in relative retention time and relative peak area.
- Vanquish Duo for Dual LC enabled simultaneous execution of drug content and impurity analyses for a drug substance in one instrument resulting in a faster product release.
- The Vanquish Duo for Dual LC concept enables running two separate methods and columns in one instrument, simultaneously and without additional equipment.
- The Vanquish Duo for Dual LC system extended with the Method Scouting Kit is a valuable solution that enables simultaneous scouting of columns with different chemistries, thereby, greatly reducing the time investment for complex method development tasks.

## References

- [1] Thermo Fisher Scientific Application Note 72601: Doubling the throughput of long chromatographic methods by using a novel Dual LC workflow
- [2] Thermo Fisher Scientific Application Note 001064: Simultaneous analysis of drug substances according to USP assay and impurity methods
- [3] Thermo Fisher Scientific Application Note 72592: Simultaneous determination of water- and fat-soluble vitamins in tablets and energy drinks by using a novel Vanquish Flex Duo system for Dual LC
- [4] Thermo Fisher Scientific Application Note 000471: Simultaneous reversed-phase and anion-exchange method scouting with a dual system for mRNA impurity determination

## Trademarks/licensing

© 2022 Thermo Fisher Scientific Inc. All rights reserved. All trademarks are the property of Thermo Fisher Scientific and its subsidiaries unless otherwise specified. This information is not intended to encourage use of these products in any manner that might infringe the intellectual property rights of others.